

*Installation and  
Operating manual*

---

***SI-Safety Module***

---

- Unidrive M

Part: 0478-0139-04

Issue: 4

**Control Techniques™**

## Original Instructions

For the purposes of compliance with the EU Machinery Directive 2006/42/EC.

### General Information

The manufacturer accepts no liability for any consequences resulting from inappropriate, negligent or incorrect installation or adjustment of the optional parameters of the equipment or from mismatching the variable speed drive with the motor.

The contents of this guide are believed to be correct at the time of printing. In the interests of commitment to a policy of continuous development and improvement, the manufacturer reserves the right to change the specification of the product or its performance, or the content of the guide without notice.

All rights reserved. No parts of this guide may be reproduced or transmitted in any form or by any means, electrical or mechanical including, photocopying, recording or by an information storage or retrieval system, without permission in writing from the publisher.

### Environmental Statement

Emerson Industrial Automation is committed to minimising the environmental impacts of its manufacturing operations and of its products throughout their life cycle. To this end, we operate an Environmental Management System (EMS) which is certified to the International Standard ISO 14001. Further information on the EMS, our Environmental Policy and other relevant information is available on request, or can be found at:

<http://www.emersonindustrial.com/en-EN/controltechniques/aboutus/environment/Pages/environment.aspx>.

The electronic variable-speed drives manufactured by Emerson Industrial Automation have the potential to save energy and (through increased machine/process efficiency) reduce raw material consumption and scrap throughout their long working lifetime. In typical applications, these positive environmental effects far outweigh the negative impacts of product manufacture and end-of-life disposal.

Nevertheless, when the products eventually reach the end of their useful life, they must not be discarded but should instead be recycled by a specialist recycler of electronic equipment. Recyclers will find the products easy to dismantle into their major component parts for efficient recycling. Many parts snap together and can be separated without the use of tools, while other parts are secured with conventional fasteners. Virtually all parts of the product are suitable for recycling.

Product packaging is of good quality and can be re-used. Large products are packed in wooden crates, while smaller products come in strong cardboard cartons which themselves have a high recycled fibre content. If not re-used, these containers can be recycled. Polythene, used on the protective film and bags for wrapping product, can be recycled in the same way. Emerson Industrial Automation's packaging strategy prefers easily-recyclable materials of low environmental impact, and regular reviews identify opportunities for improvement.

When preparing to recycle or dispose of any product or packaging, please observe local legislation and best practice.

### REACH legislation

#### REACH legislation

EC Regulation 1907/2006 on the Registration, Evaluation, Authorisation and restriction of Chemicals (REACH) requires the supplier of an article to inform the recipient if it contains more than a specified proportion of any substance which is considered by the European Chemicals Agency (ECHA) to be a Substance of Very High Concern (SVHC) and is therefore listed by them as a candidate for compulsory authorisation.

For current information on how this requirement applies in relation to specific Emerson Industrial Automation's products, please approach your usual contact in the first instance. Emerson Industrial Automation's position statement can be viewed at:

[www.emersonindustrial.com/en-EN/controltechniques/aboutus/environment/reachregulation/Pages/reachregulation.aspx](http://www.emersonindustrial.com/en-EN/controltechniques/aboutus/environment/reachregulation/Pages/reachregulation.aspx).

### Control Techniques Drives Ltd

Ty Rheoli, 79 Mochdre Ind. Est.  
Newtown, Powys SY16 4LE  
United Kingdom

Copyright : © September 2016 Control Techniques Ltd.

Issue Number : 4

---

# Contents

---

<b>1</b>	<b>Safety information .....</b>	<b>7</b>
1.1	Safety of personnel .....	7
1.2	Warnings, cautions and notes .....	7
1.3	Definition of terms .....	7
1.4	Terms and abbreviations .....	9
1.5	Intended use .....	10
1.6	General safety instructions .....	10
1.7	Electrical safety - general warning .....	11
1.8	System design and safety of personnel .....	11
1.9	Environmental limits .....	11
1.10	Compliance with regulations .....	12
1.11	Motor .....	12
1.12	Mechanical brake control .....	12
1.13	Adjusting parameters .....	12
1.14	Design of safe machinery, risk assessment and safety standards .....	13
1.15	Functional safety of electrical power drive systems .....	13
1.16	Responsibilities .....	13
1.17	Avoiding malfunction during loss of zero volts .....	14
1.18	Operation and service .....	14
1.19	Transportation / storage .....	14
<b>2</b>	<b>Device type .....</b>	<b>15</b>
2.1	SI-Safety module .....	15
2.2	Configuration .....	16
<b>3</b>	<b>Technical safety features .....</b>	<b>18</b>
3.1	Key indicators for technical safety and circuitry for connected sensors	19
3.2	Sensors for speed and/or position recording .....	25
3.3	Key technical safety indicators and energizing/engagement of the outputs .....	30
<b>4</b>	<b>Installation .....</b>	<b>35</b>
4.1	General installation notes .....	35
4.2	Installation and mounting of the SI-Safety module .....	36
4.3	Connecting the sensor power supply .....	36
4.4	Connection of digital inputs SMF11 to SMF42 and E0.5 .....	36
4.5	Connecting position and speed sensors .....	39
4.6	Connecting the proximity switch .....	41
4.7	Combining different types of encoder .....	41
4.8	Configuration of measuring routes .....	42
4.9	Incremental sensor: .....	44
<b>5</b>	<b>SI-Safety module response times .....</b>	<b>45</b>
5.1	SI-Safety module response times .....	45
5.2	Response times for response in standard operating mode .....	45
5.3	Response times for FAST_CHANNEL .....	46
5.4	Response times for fault distance monitoring .....	47

<b>6</b>	<b>Start-up</b> .....	<b>49</b>
6.1	Procedure .....	49
6.2	Configuration .....	49
6.3	Function test .....	50
6.4	Validation .....	50
6.5	Technical safety test .....	50
<b>7</b>	<b>Maintenance</b> .....	<b>51</b>
7.1	Modification .....	51
7.2	Module replacement .....	51
7.3	Maintenance intervals .....	51
7.4	Diagnostic parameters .....	51
7.5	Input / output status indication .....	57
7.6	Software diagnostics .....	57
<b>8</b>	<b>Technical data</b> .....	<b>58</b>
8.1	Environmental conditions .....	58
8.2	Key technical safety indicators .....	58
<b>9</b>	<b>SI-Safety error types</b> .....	<b>59</b>
9.1	SI-Safety error types .....	59
9.2	SI-Safety alarm list .....	60
9.3	Fault list for SI-Safety .....	72
<b>10</b>	<b>Encoder types</b> .....	<b>81</b>
<b>11</b>	<b>Validation report</b> .....	<b>82</b>
11.1	Overview .....	82
11.2	Report generation .....	82
11.3	Report format .....	82
<b>12</b>	<b>Encoder adaptor</b> .....	<b>83</b>
12.1	Overview .....	83
12.2	Single encoder adapter .....	83
12.3	Dual encoder adapter .....	84
12.4	Connector details .....	86
12.5	Electromagnetic Compatibility (EMC) .....	86
<b>13</b>	<b>Amendments</b> .....	<b>87</b>
13.1	Amendments Index .....	87

---

## Declaration of Conformity (including 2006 Machinery Directive)

---

**Control Techniques Ltd**  
**The Gro**  
**Newtown**  
**Powys**  
**UK**  
**SY16 3BE**

**Moteurs Leroy-Somer**  
**Usine des Agriers**  
**Boulevard Marcellin Leroy**  
**CS10015**  
**16915 Angoulême Cedex 9**  
**France**

This declaration applies to the SI-Safety option module which is a detachable module intended for use with the Control Techniques Unidrive M600 to M800 variable speed drive product ranges.

The module is a programmable device which can carry out safety-related control functions for a machine, when used in conjunction with the appropriate drive.

**This declaration relates to the option module when used as a safety component of a machine. Only the defined safety functions may be used for a safety function of a machine. None of the other functions of the module or the drive may be used to carry out a safety function.**

These products fulfil all the relevant provisions of Directives 2006/42/EC (The Machinery Directive) and 2004/108/EC (The EMC Directive) and 2006/95/EC (The Low Voltage Directive).

EC type-examination has been carried out by the following notified body:

TÜV Rheinland Industrie Service GmbH

Am Grauen Stein

D-51105 Köln

Notified Body identification number: 0035

EC type-examination certificate number: 01/205/5409.00/14

The harmonized standards used are shown below:

EN 61800-5-1:2007 <sup>1</sup>	Adjustable speed electrical power drive systems - safety requirements - electrical, thermal and energy
EN 61800-5-2:2007	Adjustable speed electrical power drive systems. Safety requirements. Functional
EN ISO 13849-1:2008 + AC:2009	Safety of machinery. Safety-related parts of control systems. General principles for design
EN62061:2005+AC:2010+A1:2013	Safety of machinery. Functional safety of safety-related electrical, electronic and programmable electronic control systems
EN60204-1:2006 + A1:2009+AC:2010 (in extracts)	Safety of machinery. Electrical equipment of machines. General requirements

Other standards used:

IEC 61508 parts 1 - 7:2010	Functional safety of electrical/electronic/programmable electronic safety-related systems
----------------------------	---

<sup>1</sup>Under the responsibility of Control Techniques. Not used for type examination.

Person authorised to compile the technical file:

C Hargis

Chief Engineer

Newtown, Powys. UK



**T. Alexander**

**VP Technology**

**Date: 11th November 2014**

**Place: Newtown, Powys. UK**

### **IMPORTANT NOTICE**

**This option module is intended to be used with the specified drives and appropriate motors, sensors, electrical protection components and other equipment to form complete control systems of machines. It is the responsibility of the installer to ensure that the design of the complete machine, including its safety-related control system, is carried out in accordance with the requirements of the Machinery Directive and any other relevant legislation. The use of a safety-related option module or drive in itself does not ensure the safety of the machine. Compliance with safety and EMC regulations depends upon installing and configuring inverters correctly. The inverters must be installed only by professional assemblers who are familiar with requirements for safety and EMC. The assembler is responsible for ensuring that the end product or system complies with all the relevant laws in the country where it is to be used. Refer to the *Drive User Guide*.**

# 1 Safety information

## 1.1 Safety of personnel

Definition of individual target groups

Personnel involved in projects relating to safe drive systems

- Engineers and technical staff

Assembly, electrical installation, maintenance and equipment replacement

- Plant electricians and service technicians

Start-up, operation and configuration

- Engineers and technical staff

## 1.2 Warnings, cautions and notes



A **Warning** contains information, which is essential for avoiding a safety hazard.



A **Caution** contains information, which is necessary for avoiding a risk of damage to the equipment and motor.

### NOTE

A **Note** contains information, which helps to ensure correct operation of the product.

## 1.3 Definition of terms

The term SI-Safety Module is used to describe all derivatives of the SI-Safety Module product line. If reference is made in this description to a defined derivative, the complete designation is always employed.

The term 'safe' as used in this manual refers in each instance to the assignment of a safe function for applications extending up to PL e, as defined in EN ISO 13849-1:2006 and/or SIL 3 in accordance with EN 61508.

The systems software 'CTSafePro' is used for configuration and programming of the SI-Safety module.

Internally, the modules in the SI-Safety module range are constructed from two independent processing units. These will be referred to as System A and System B within this manual.

**Table 1-1 Other applicable documents**

Description	Reference
Configuration of the SI-Safety module for standalone applications with the 'CTSafePro' program.	'CTSafePro' help text
Validation report for implemented PLC program and parameters.	Safety inspection with approval record
Approval	TÜV certificate for product modules SI-Safety module

**NOTE**

Read the relevant manuals carefully before installation and commissioning the SI-Safety module. Compliance with all documentation is essential for fault free operation, and to safeguard cover in the event of a warranty claim.



## 1.4 Terms and abbreviations

Table 1-2 Terms and abbreviations

Abbreviation	Description
AC	Alternating current
AWL	Instruction set
BGIA	German government safety organization
CCF	Common-caused failures recognition
CLK	Cycle (clock)
CPU	Central Processing Unit
DC <sub>avg</sub>	Diagnostic cover level on demand
DO	Digital Output
ELC	Emergency Limit Control
EMC	Electromagnetic Compatibility
EMU	Emergency Monitoring Unit
EN	European standard
IP20	Protection class for enclosures
ISO	International Organisation for Standardization
LED	Light Emitting Diode
MTTF <sub>d</sub>	Mean Time To Failure in the dangerous direction
OSSD	Output Signal Switch Device
PAA	Process diagram for outputs
PAE	Process diagram for inputs
P1,P2	Pulse outputs 1, 2
PLC	Programmable Logic Control
SBC	Safe Brake Control
SCA	Safe Cam
SDI	Safe Direction
SEL	Safe Emergency Limit
SELV	Safety Extra Low Voltage
SLI	Safe Limited Increment
SLP	Safe Limited Position
SLS	Safe Limited Speed
SI	Solutions Interface
SMF11 to SMF42, E0.5	Digital input
SOS	Safe Operating Stop
SS1	Safe Stop 1
SS2	Safe Stop 2
SSI	Synchronous Serial Interface
STO	Safe Torque Off
TÜV	German Technical Inspections Organization
HISIDE	Output switching to + ("high side") with nominal level of 24 Vdc
PES	Programmable Electronic System

Safety Information
Device type
Technical safety features
Installation
SI-Safety module response times
Start-up
Maintenance
Technical data
SI-Safety error types
Encoder types
Validation report
Encoder adaptor
Amendments
Index

## 1.5 Intended use

The SI-Safety module expansion module is a programmable safety controller used in the manufacture of safety trip circuits and other safety functions. This module is designed for the following uses:

- In EMERGENCY STOP equipment.
- As a safety components as defined in EC Machinery Directive 2006/42/EC.
- As a PES for risk reduction as defined in EN 61508.
- In safety power circuits in accordance with EN 60204-1 and EN 60204-32.
- As a PES for functional safety as defined in EN 62061.
- As an SRP/CS as defined in EN ISO 13849.
- As a device for producing the safety functions defined in EN 61800-5-2.
- As a logic unit for signal conversion and processing in two handed circuits as defined in EN 574.



The SI-Safety module expansion module is a safety component as defined in Annex IV of the EC Machinery Directive 2006/42/EC. It was developed, designed and produced in strict accordance with the above directive, and with the EC EMC Directive 2004/108/EC.

## 1.6 General safety instructions



### Safety instructions

- To avoid personal injury and damage to equipment, all work on this device must be carried out by personnel with training regarding the technical aspects of electrical engineering.
- Each appropriately skilled person must be familiar with the operating instructions (cf. IEC 60364).
- Each appropriately skilled person must, as a minimum requirement, have an in-depth knowledge of national health and safety at work (HSW, i.e. accident prevention) specifications and legislation.
- Use of these devices is restricted to their intended use, in accordance with the previous itemised list. Due compliance with the figures and data listed in Table 3-1 on page 18 is mandatory.
- The contents of this installation manual is restricted to the basic functions of these devices, and the installation procedure for them. More detailed information about the programming and re-configuration of these devices can be found in the 'SI-Safety module programming manual'. Detailed knowledge and understanding of these aspects is vitally necessary prior to first time installation and/or modification of equipment functions or device parameters.
- Commissioning / start-up is only permitted on condition that the EMC directive is followed to the letter. On the basis of EMC test specifications EN 55011:2007 + A2:2007 and EN 61000-6-2:2005.
- For storage and transport, due compliance is required with the conditions defined in EN 60068-2-6 in relation to the figures given in Table 3-1 on page 18.
- Compliance with the wiring and connection instructions in the 'Installation' chapter is mandatory.
- The applicable safety specifications must be observed in respect of this application.
- The configured monitoring functions and their parameters and links must be verified through the use of a validation report.

- Implementation of this module must be agreed and matched to the requirements of the relevant commissioning body.
- Never install or commission damaged products. Please report all instances of damage immediately to the transport company.
- Never open the housing and/or undertake conversion work independently.
- The inputs and outputs for standard functions, and/or the digital and analog data transmitted by communication modules must never be used for safety-related applications.

## 1.7 Electrical safety - general warning

The voltages used in the drive can cause severe electrical shock and/or burns, and could be lethal. Extreme care is necessary at all times when working with or adjacent to the drive. Specific warnings are given at all relevant places in this manual.

## 1.8 System design and safety of personnel

Only functions which are explicitly described as safety functions may be used to ensure the safety of personnel, i.e. no other functions of the drive or its option modules must be used for safety-related functions.

The only safety function provided in the Unidrive M is Safe Torque Off.

The Safe Torque Off function has been approved by TÜV Rheinland as meeting the requirements of the following standards, for the prevention of unexpected starting of the drive:

EN 61800-5-2:2007 SIL 3

EN ISO 13849-1:2006 PL e

The Safe Torque Off function may be used in a safety-related application. The system designer is responsible for ensuring that the complete system is safe and designed correctly according to the relevant safety standards.

The design of safety-related systems requires specialist knowledge. To ensure that a complete control system is safe, it is necessary for the whole system to be designed according to recognized safety principles. The use of individual sub systems such as drives and option modules with safety functions, which are intended for safety-related applications, does not in itself ensure that the complete system is safe. It is the responsibility of the designer of the end product or application to ensure that it is safe and in compliance with the relevant regulations. Any application examples given in this guide are for illustration only and do not purport to represent complete solutions.

## 1.9 Environmental limits

Instructions in this User Guide regarding transport, storage, installation and use of the drive must be complied with, including the specified environmental limits. Drives must not be subjected to excessive physical force.

Safety Information
Device type
Technical safety features
Installation
SI-Safety module response times
Start-up
Maintenance
Technical data
SI-Safety error types
Encoder types
Validation report
Encoder adaptor
Amendments
Index

## 1.10 Compliance with regulations

The installer is responsible for complying with all relevant regulations, such as national wiring regulations, accident prevention regulations and electromagnetic compatibility (EMC) regulations. Particular attention must be given to the cross sectional areas of conductors, the selection of fuses or other protection, and protective earth (ground) connections.

This manual contains instructions for achieving compliance with specific EMC standards.

Within the European Union, all machinery in which this product is incorporated must comply with the following directives:

- 2006/42/EC: Safety of machinery.
- 2004/108/EC Electromagnetic Compatibility.

## 1.11 Motor

Ensure the motor is installed in accordance with the manufacturer's recommendations. Ensure the motor shaft is not exposed.

Standard squirrel cage induction motors are designed for single speed operation. It is strictly prohibited to use the motor with higher speeds than are deemed maximum.

Low speeds may cause the motor to overheat because the cooling fan becomes less efficient. The motor should be installed with a protection thermistor. If necessary, an electric forced vent fan should also be used.

The values of the motor parameters set in the drive affect the protection of the motor. The default values in the drive should not be relied upon.

It is essential that the correct value is entered in Pr **00.046** motor rated current. This affects the thermal protection of the motor.

## 1.12 Mechanical brake control

The drive brake control functions are provided to allow well co-ordinated operation of an external brake with the drive. While both drive hardware and software are designed to high standards of quality and robustness, they are not intended for use as safety functions, i.e. where a fault or failure would result in a risk of injury. In any application where the incorrect operation of the brake release mechanism could result in injury, independent protection devices of proven integrity must also be incorporated. The SI-Safety module Safe Brake Control (SBC) output can be connected to a suitable safety related device to provide a safety function.

## 1.13 Adjusting parameters

Some parameters have a profound effect on the operation of the drive. They must not be altered without careful consideration of the impact on the controlled system. Measures must be taken to prevent unwanted changes due to error or tampering.

## 1.14 Design of safe machinery, risk assessment and safety standards

The safety features of a machine should be designed at the same time as its intended functions. An initial risk assessment should be carried out, which should be in accordance with the ISO 14121 (EN ISO 14121) standards (previously EN 1050). The risk assessment identifies whether safety-related control functions are needed in addition to the inherent safety features of the machine.

The standards currently available for the safety of machinery control systems are ISO 13849-1 and IEC 62061 (EN ISO 13849-1:2006 and EN 62061). ISO 13849-1 measures the degree of safety integrity by a "Performance level" with values from a (lowest) to e, while IEC 62061 uses the principles of IEC 61508 to give a SIL (Safety Integrity Level) from 1 (lowest) to 3. Both of these standards allow for the use of complex hardware and software in safety-related control systems.

## 1.15 Functional safety of electrical power drive systems

Some types of safety-related control functions can usefully be carried out in the drive. Standard IEC 61800-5-2 (EN 61800-5-2) defines specific functions for implementation within a drive. The activation of these functions is carried out through safety features on the machine such as door switches and light curtains, which can be connected directly to the SI-Safety module. Alternatively more complex functions can be carried out in a separate safety controller, which can then be connected to the safe interface of the SI-Safety module.

## 1.16 Responsibilities

It is the responsibility of the machine/equipment designer to ensure the safety of the machine/equipment, including the correct configuration and integration of the SI-Safety module which is required to achieve the necessary safe operation. It is also the responsibility of the machine/equipment designer to ensure that the SI-Safety module meets the requirements of the application, i.e. that the function specified is the correct one for the application and that the integrity data is adequate.

Control Techniques is not responsible for:

- The correct incorporation/configuration of the SI-Safety module into a complete safety-related control system.
- The correct application of the SI-Safety module or a safety-related control system in a machine.

## 1.17 Avoiding malfunction during loss of zero volts

To avoid accidental voltage errors at a safe output, the output circuit must always be returned to the inverter 0 V terminal, and not to a 0 V connection elsewhere in the system. If the safe output is not directly connected to the drive Safe Torque Off then the following basic circuit should be used.

**Figure 1-1 Loss of zero volts protection**

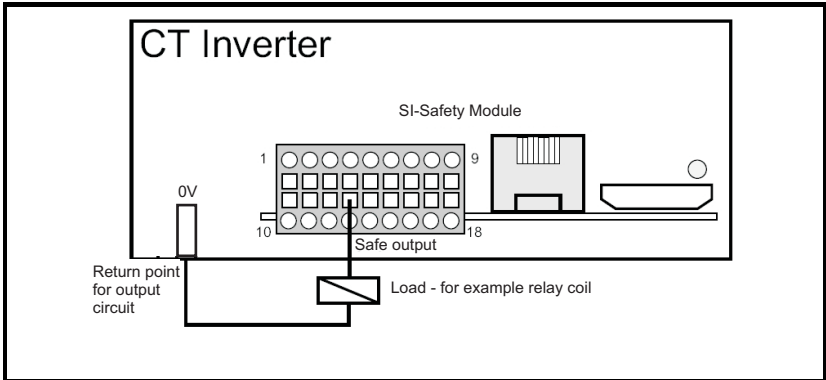

## 1.18 Operation and service

Before installing and removing a module, or disconnecting signal lines, first isolate the module electrically, i.e. shut it down.

While installing and removing a module, take appropriate precautions to prevent electrostatic discharge on the externally routed terminals and plug connections.

## 1.19 Transportation / storage

Instructions regarding transportation, storage and proper handling must be followed. Climate specifications must be observed in accordance with Table 8-1 on page 58.

## 2 Device type

### 2.1 SI-Safety module

The SI-Safety module is a compact safety controller with integrated drive monitoring for an axis. This device can be programmed at will to assure safe processing. This encompasses the EMERGENCY STOP buttons, two-handed operation, light grids, operating mode selector switches etc., as well as drive-related safety functions. For a large number of input devices, pre-configured modules are available for safety-related pre-processing of signals. The same applies to safety functions for drive unit monitoring. Details can be found in *CTSafePro help*.

The basic version of this device has safe inputs for a maximum of five input elements and three disengagement channels.

For 'safe' recording of speed and/or positions, single sensor solutions (Incremental, SIN/ COS, Proxi-Switch) as well as 2-sensor solutions (e.g. Incremental or SSI and Incremental.) are supported.

**Table 2-1 Device version**

Device version	
Module design with the following peripherals:	
2	Sensor interfaces
4 x 2	Grouped safe digital inputs
1 x 1	Safe digital input (monitoring)
2	Impulse outputs
3	HISIDE safe outputs
2	Message outputs
1	Diagnosis and configuration interface
1	Status LED

**NOTE**

The SI-Safety module can only be installed in option module slot 3. The drive only provides power to the SI-Safety module, there are no interface signals between the module and the drive. The drive will not detect that the module is installed, and no parameters will be displayed in Menu 17.

#### 2.1.1 Module properties

- Logic processing up to PI=e in accordance with EN ISO 13849-1 and/or SIL 3 in accordance with EN 61508
- Freely programmable small controller for instructions of up to 500 statements
- Functional plan-oriented programming
- Impulse outputs for cross-fault detection of digital input signals
- Safety function, external contact monitoring of connected switchgear
- Monitored HISIDE outputs for safety-related functions

**Table 2-2 Key technical indicators**

<b>Key technical safety indicators</b>	
PI in accordance with EN ISO 13849:2006	PL e
PFH / architecture	PFH <sub>sys</sub> = 5.44 E-9 1/h / category 4
SIL in accordance with EN 61508	SIL 3
Proof test interval	20 years = maximum service life
<b>General data</b>	
Safe digital I grouped/not grouped	4/1
Safe digital Out	3
Message outputs	2
Impulse outputs	2
Type of connection	Screw terminals (MINIMATE 2X9)
Sensor interface, front, number / technology	2 / SSI; incremental (SIN/COS, TTL)
Maximum frequency incremental (SIN/COS, TTL)	250 kHz
Clock frequency/SSI mode	Master Mode 250 kHz, Slave Mode 100 kHz - 300 kHz
Type of connection	HDMI- gold connectors, maximum cable length is 1 metre
Proxi input (E0.5)	Max. 250 kHz
<b>Electrical data</b>	
Nominal data, digital I	24 Vdc; 20 mA, Typ1 in accordance with EN 61131-2
Nominal data, digital O	24 Vdc; 500 mA (SBC1/2) 30 mA (STO1)
Impulse outputs	100 mA maximum
<b>Environmental data</b>	
Temperature	operating temperature: 0 ° to 50 °C storage temperature: -10 °C to 70 °C
Protection class	IP 20
Climate class	3 accordance with EN 50178:1998
EMC	In accordance with EN 55011 and EN 61000-6-2:2005

## 2.2 Configuration

*CTSafePro* is a graphical PC tool which enables configuration of the speed encoder interface, definition of the safe motion functionality and logic operations. It also provides testing and advanced diagnostic tools.

The configuration is saved and protected against line power supply failure within the module.

Refer to *CTSafePro help* for details of how to configure the SI-Safety module.



## 2.2.1 Downloading the configuration to the SI-Safety module

The configuration is downloaded to the SI-Safety module via a CT USB communications cable (4500-0096) connected between the PC and the SI-Safety module RJ45 port. Refer to the *CTSafePro help* for details regarding download and configuration.

	<p>An isolated USB communications cable must be used to connect the SI-Safety module to IT equipment (such as laptop computers). Suitable cables are available from Control Techniques.</p>
---	---

## 2.2.2 Option module identification

The SI-Safety can be identified by:

- The label located on the underside of the option module.
- The color coding across the front of the SI-Safety (Yellow).

**Figure 2-1 Model plate**



1. Topside module label
2. Underside module label.

## 2.2.3 Date code format

The date code is split into two sections: a letter followed by a number. The letter indicates the year, and the number indicates the week number (within the year) in which the Option module was built. The letters go in alphabetical order, starting with A in 1990 (B in 1991, C in 1992 etc.).

### Example:

A date code of **X28** would correspond to week 28 of year 2014.

## 2.2.4 The scope of supply includes:

The SI-Safety module with connector.

The scope of supply does not include:

- 'CTSafePro' configuration software with
  - Installation and Operating manual
  - Drivers for programming cable
- Programming cable
- Licence key (USB dongle) for 'CTSafePro'
- Encoder adaptor module

### 3 Technical safety features

The internal design of the SI-Safety module comprises two separate channels with two way cross checking of results. Both channels employ high quality diagnostics for troubleshooting purposes.

The layout corresponds to Category 4 of EN ISO 13849-1:2006 in terms of architecture and functional method, i.e. operation.

**Figure 3-1 SI-Safety module Layout**

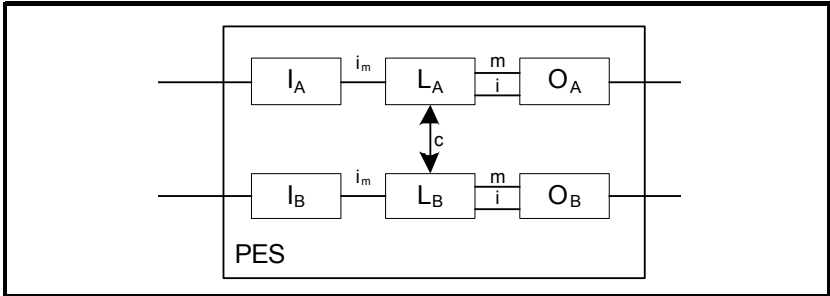

The overall architecture is configured as follows: [sensor] [PES]=[Actuator]

**Figure 3-2 Overall architecture**

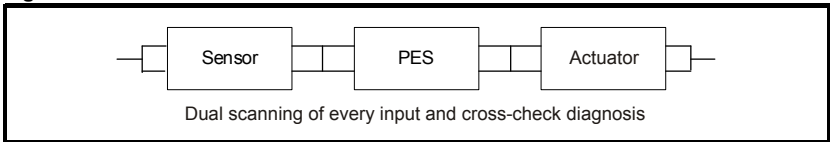

The specific Key Technical Safety Indicators can be found on page 19.

For the technical safety evaluation of complete systems, the key technical indicators identified in this chapter for the PES sub system (Table 3-1 on page 18) can be applied (e.g. PL e and PFH value in accordance with the verification table defined in EN ISO 13849).

**Table 3-1 Key technical safety indicators**

Maximum achievable safety class	SIL 3 in accordance with EN 61508 Performance Level e in accordance with EN ISO 13849-1:2006
System structure	Two channel with diagnosis (1oo2) in accordance with EN 61508 Architecture category 4 in accordance with EN ISO 13849
Configuration of operating mode	'high demand' in accordance with EN 61508 (high requirement rate)
Probability of a potentially dangerous failure on an hourly basis (PFH figure)	see <i>Key technical indicators on page 16</i>
Proof Test Interval (EN 61508)	20 years, then the module needs to be replaced



## Safety instructions

- The specific key technical safety indicators for this module can be found in Chapter 3, Key technical safety indicators (Table 3-1).
- When using several sensors with different functions (e.g. position indicator, access door + speed recording) for a safety function (e.g. safe reduced speed with access door open), these must be included as an inline circuit in any technical safety assessment of the complete system.
- Due compliance with safety specifications and EMC directives is mandatory.
- With regard to the fault exclusions made, reference is made to the Tables listed under D in the Annex to EN ISO 13849-2.
- For the technical safety evaluation of complete systems, the key technical indicators identified in Chapter 3 for the PES sub system (Table 3-1) can be applied (e.g. PL e and PFH value in accordance with the verification table defined in EN ISO 13849)

The examples shown below and their characteristic architecture, are largely responsible for assignment to a category as defined in EN ISO 13849-1:2006.

The resultant maximum possible Performance Levels defined in EN ISO 13849 remain dependent on the following factors for external components:

- Structure (simple or redundant)
- Detection of faults with a common cause (CCF)
- Diagnosis coverage level on request (DCavg)
- Time until dangerous failure of a channel (MTTFd)

## 3.1 Key indicators for technical safety and circuitry for connected sensors

The SI-Safety module has completely separate signal processing paths for each safety input. Furthermore, design measures enable the highest possible DC levels to be reached.

### 3.1.1 Digital sensors and command devices:

Two channel signal processing and diagnosis through cross checking in the PES.

**Figure 3-3 Grouped inputs**

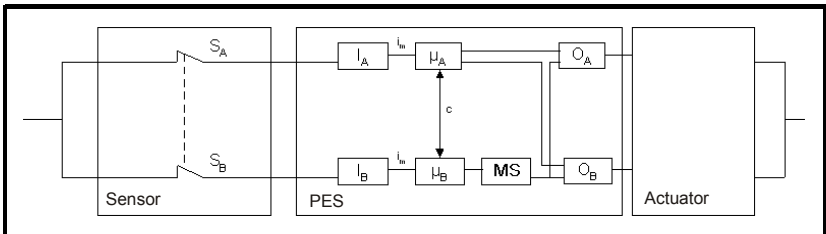

Dual scanning and signal processing in two channels, diagnosis through cross checking in the PES.

Safety Information
Device type
Technical safety features
Installation
SI-Safety module response times
Start-up
Maintenance
Technical data
SI-Safety error types
Encoder types
Validation report
Encoder adaptor
Amendments
Index

**Figure 3-4 Non grouped inputs**

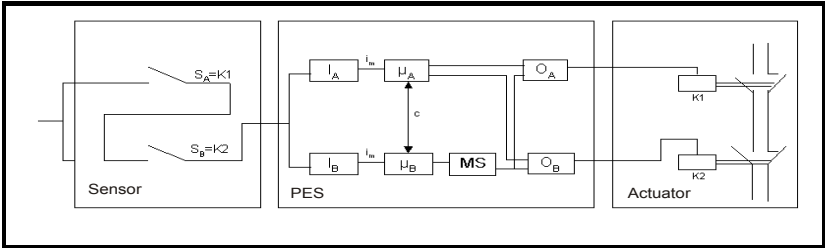

The SI-Safety module provides extensive diagnostic functions for the input sub system. These functions are performed continuously, and/or optionally, i.e. cross-fault monitoring using impulse detection.

This means that the following input sensor diagnostic functions can always be used in any technical safety assessment of the complete system:

**Table 3-2 Digital input signals**

Measure	DC	Comment	Use
Cyclical test impulse through dynamic change to the input signals	90 %	Only effective if pulse assignment is active	cross-fault monitoring for single channel sensors
Crosscheck of input signals with a dynamic test, if no short circuits can be detected (on multiple inputs/ outputs)	90 %	Cyclical change in input signals required, e.g. by the process or through regular actuation	Monitoring of two channel sensors
Crosscheck of input signals with immediate and interim results in the logic unit (L) and time wise and logical program runtime monitoring, and detection of static failures and short circuits (on multiple inputs and outputs)	99 %	Only effective if pulse assignment is active	Monitoring of two channel sensors
Plausibility check, e.g. use of NO and NC contacts on restraint guided relays	99 %	Only effective in conjunction with activated monitoring function for the input element	Monitoring of two channel, complementary sensors



## Safety instructions

- For a technical safety assessment of the sensor sub system, manufacturer's data (MTTFd, FIT figures etc.) need to be incorporated.
- The DC figures quoted in Table 3-2 need to be applied in a conservative manner, and compliance with the parameters in the Comments section need to be observed.
- Fault exclusions are permitted in accordance with the applicable standards. Compliance with the parameters listed here must be assured at all times.
- If several sensor systems are required to assure proper function of an individual safety function, always merge their partial values correctly in accordance with the selected procedure.

**Table 3-3 Classification of digital inputs**

Digital inputs	Performance level	Comment
SMF11/SMF12 to SMF41/SMF42	PL e	Requires two channel inputs with cross fault checking using clock outputs (see Figure 3-9 and Figure 3-10 for examples)
E0.5	PL d	Restriction in disengagement Fault detection 'on demand'. If a single channel input is used, then cross-fault checking is required using a clock output (see Figure 3-8 for example)

### 3.1.2 Single channel sensor without cross-fault checking

The single channel sensor is connected to the SI-Safety module without clocking action (pulsing cycles), and/or without cross-fault checking This design is not advisable for safety-related applications. A maximum PL b in accordance with EN ISO 13849-1:2006 can be achieved.

**Figure 3-5 Single channel sensor without cross-fault checking**

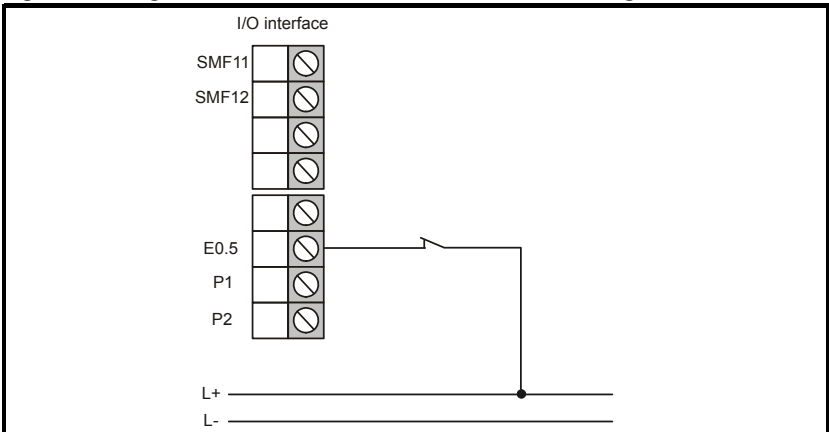

### 3.1.3 Two channel sensor without cross-fault checking

The use of two channel sensors without clocking action and/or without cross-fault checking can cause problems under certain circumstances. A short circuit on the signal line of the two channel sensor, e.g. in the cable, cannot be detected. A safe operating mode can only be achieved by routing cables separately, and by eliminating the possibility of a short circuit across terminals.

This type of connection is not advisable for safety-related applications outside of the drive system enclosure. Taking the fault exclusion of cross-faults into account, PLd can be achieved in accordance with EN ISO 13849-1:2006.

**Figure 3-6 Two channel sensor without cross-fault checking**

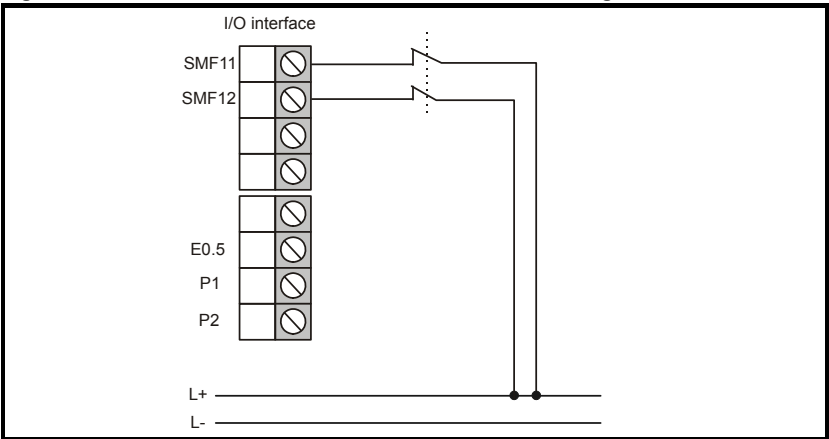

### 3.1.4 Two channel complementary sensor without cross-fault checking

The use of two channel complementary sensors without clocking action and/or without cross-fault checking can be used in a safety related application. Taking the fault exclusion of cross-faults into account, PLd can be achieved in accordance with EN ISO 13849-1:2006.

**Figure 3-7 Two channel complementary sensor without cross-fault checking**

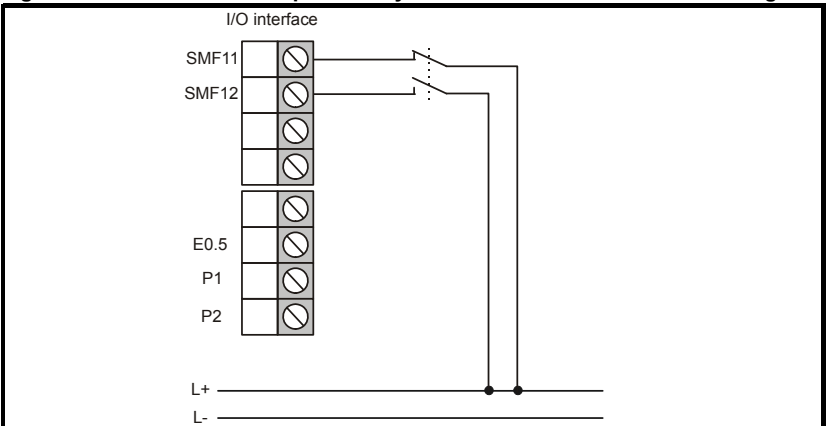

### 3.1.5 Single channel sensor with pulse cross-fault checking

When using a single channel sensor with clocking action, a connection is made to clocking output P1 or P2. The clocking action on the SI-Safety module needs to be configured correctly.

When using a single channel sensor with clocking action the following faults are detected:

- Short circuit to supply voltage 24 Vdc
- Short circuit to 0 Vdc
- Cable interrupt (power disconnection in the 'safe' state)

However, caution should be taken because the system will not detect either a cable short circuit between the two sensor connections, or a short circuit between P1 and E0.5.

When using an appropriate switch element and with careful wiring of the sensor, PL d can be achieved in accordance with EN ISO 13849-1:2006.

**Figure 3-8 Single channel sensor with clocking action**

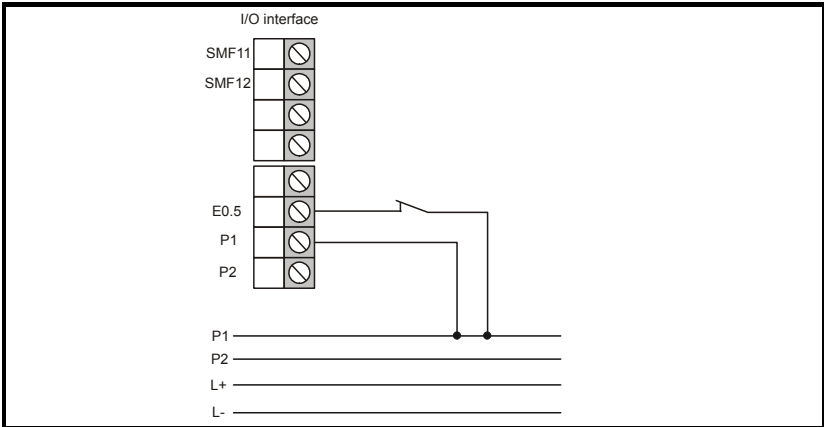

**NOTE**

PL e compliance with EN ISO 13849-1:2006 is achieved if it is possible to exclude the possibility of a short circuit between E0.5 and P1 and a short circuit between the sensor connections. Ensure that the switch has forced opening action. In addition, the sensor needs to be activated at regular intervals, and the safety function checked for correct operation. Fault exclusions can be achieved in accordance with EN ISO 13849-2, Table D8.

### 3.1.6 Two channel sensor with cross-fault checking

Through the use of two independent clocking signals on a non-complementary sensor, all cross-faults and connections to 24 Vdc and 0 Vdc can be detected. For all safety applications, only NC contacts are used, without exception.

**Figure 3-9 Two channel non-complementary sensor with clocking action**

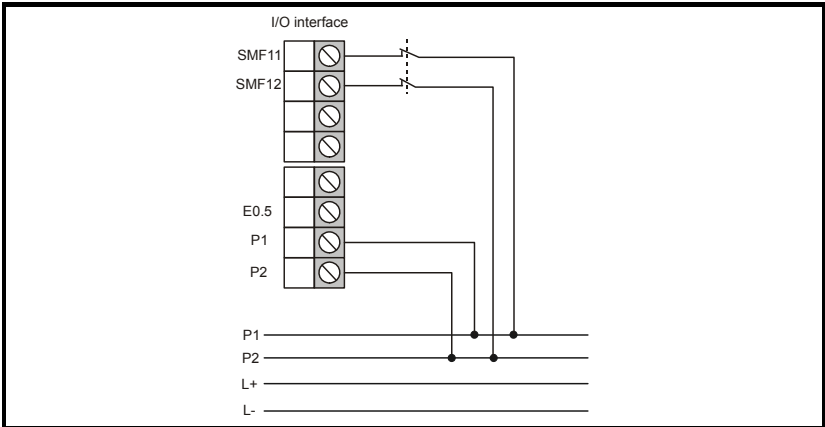

### 3.1.7 Two channel complementary sensor,

When connecting a complementary sensor, always ensure that only the NC contact is tested continuously by the clocking action. All types of fault are detected in the feed/ input.

When using approved switch elements with forced opening action, it is possible in both cases to achieve PL e compliance in accordance with EN ISO 13849-1:2006.



#### Safety instructions

- PL e compliance with EN ISO 13849-1:2006 can be achieved where it is possible to exclude the possibility of a short circuit between input and associated pulse output, and of a short circuit between the sensor connections.
- Under such conditions, ensure that the switch has forced opening action in the event of a fault. In addition, the sensor needs to be activated at regular intervals, and the safety function checked for correct operation.
- Fault exclusions can be achieved in accordance with EN ISO 13849-2, Table D8. With single channel use of these inputs, the achievable safety level is restricted to SIL 2 and/or PL d, if a safety function is requested at regular intervals.
- In all cases, these safety related inputs should only be used in a technical safety context in conjunction with pulse outputs.



**Figure 3-10 Two channel complementary sensor**

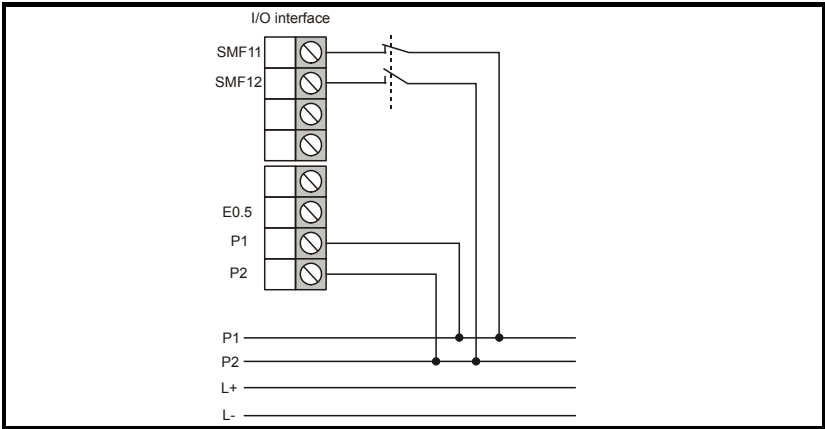

## 3.2 Sensors for speed and/or position recording

### 3.2.1 General technical safety surface mounted sensor interface for position and/or speed.

The SI-Safety module has two encoder interfaces.

Depending on the type and combination of encoders, different safety levels can be achieved. The following system configuration emerges for a corresponding sub system: Figure 3-11 shows a dual channel sensor system with separate signal processing in two channels, diagnosis through cross checking in the PES.

**Figure 3-11 Sensors for speed and/or position recording**

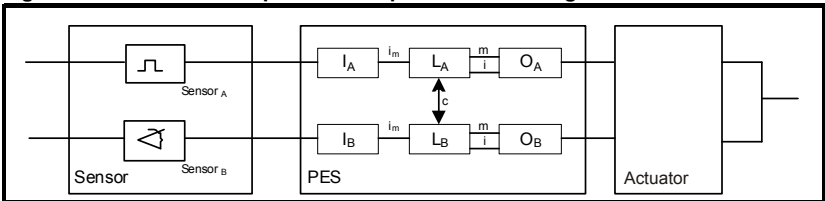
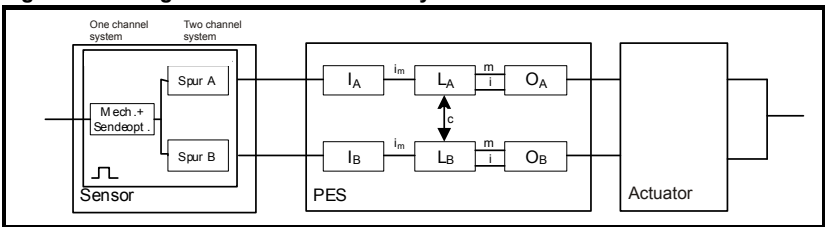

Figure 3-12 illustrates a sensor system with one and two channel subsystem (example: incremental encoder). Diagnosis using separate signal processing in two channels and cross checking in the PES as well as other specific forms of diagnosis

**Figure 3-12 Single and two channel subsystem**



### 3.2.2 General diagnostic measures for encoder interface

To detect faults in the sensor system, a range of diagnostic measures have been implemented dependent on the selected type of encoder and/or a combination of types. Activation occurs automatically, with selection of the type of encoder.

Essentially, these diagnostic measures can be classified in terms of their type and their effectiveness, as shown in Table 3-4.

**Table 3-4 Diagnostics for sensors for recording position and/or speed**

Measure	DC	Comment	Use
Crosscheck of input signals with immediate and interim results in the logic unit (L) cyclic and logical program runtime monitoring, and detection of static failures and short circuits (on multiple inputs and outputs)	99 %	Only to be used on: <ul style="list-style-type: none"> <li>• Two channel sensor systems (two separate sensors)</li> <li>• The two channel subsystem of single channel sensors (incremental encoder)</li> <li>• Diagnosis for the single and dual channel subsystem of specifically suitable sensor systems (SIN/COS encoder)</li> <li>• Dynamic operation / no standstill monitoring</li> </ul>	Monitoring of two channel sensor systems and/or the corresponding subsystem of sensors for dynamic operation Not to be used for standstill monitoring!
Crosscheck of input signals without a dynamic test	80 % to 95 %	DC is dependent on the frequency of occurrence of the dynamic state, i.e. stationary or in motion, and on the quality of the type of monitoring action (80 % to 90 % for incremental encoders, 95 % for SIN/COS encoders)	Monitoring of two channel sensor systems and/or the corresponding subsystem of sensors for non dynamic operation To be used especially for standstill monitoring!
Monitoring of a few features of the sensor (response time, the range of analog signals, e.g. electrical resistance, capacity)	60 %	Diagnosis of specific features of sensors, only applicable to speed and position sensors as defined in section 3.3 <i>Key technical safety indicators and energizing/engagement of the outputs</i> on page 30.	Monitoring of the single channel subsystem by single channel sensor systems

**Table 3-5 Encoder types and their combinations, and key diagnostic data**

Process encoder	Sensor Type		Pulse input on E0.5	Safety Function			Fault exclusion	Assignable Diagnostic Coverage (DC)			Safety Information
	Reference encoder	Not connected		Safe speed	Safe direction	Safe position		1-channel system	2-channel system, dynamic	2-channel subsystem, non-dynamic (standstill monitoring)	
Incremental	Not connected	Not connected	X			Fault exemption *	60%	99%	80-90%		
Incremental	Incremental	Not connected	X	X			Not applicable	99%	95%		
Incremental	Not connected	Proximity Sensor	X				Not applicable	99%	90-95%		
SIN/COS	Not connected	Proximity Sensor	X				Not applicable	99%	90-95%		
Incremental	SIN/COS	Not connected	X	X			Not applicable	99%	99%		
Incremental	SSI	Not connected	X	X	X		Not applicable	99%	90-95%		
SIN/COS	Not connected	Not connected	X	X		Fault Exemption *	90%	99%	90-95%		
SIN/COS	Incremental	Not connected	X	X			Not applicable	99%	95-99%		
SIN/COS	SSI	Not connected	X	X	X		Not applicable	99%	95-99%		

\*mechanical shaft failure, positive shaft connection essential

Index	Amendments	Encoder adaptor	Validation report	Encoder types	SI-Safety error types	Technical data	Maintenance	Start-up	SI-Safety module response times	Installation	Technical safety features	Device type	Safety Information
-------	------------	-----------------	-------------------	---------------	-----------------------	----------------	-------------	----------	---------------------------------	--------------	---------------------------	-------------	--------------------

**Table 3-6 Specific diagnostic measures relating to the type of encoder used**

	Encoder type	Monitoring of the source voltage	Differential level monitoring	SIN/COS plausibility monitoring	Monitoring signal level, input level	Monitoring of permitted quadrants	Monitoring of the count signal separated for track A/B
Interface HDMI, E0.5	Incremental	X	X				X
	SIN/COS	X		X			
	SSI	X	X				
	PROXI 1 x numeral input	X					
	Incremental	X	X		X		X

### 3.2.3 Safety directed disengagement thresholds for encoder systems for position and speed recording

As a basic precaution, plausibility tests are performed between measuring channels A and B for the speed and position of the SI-Safety module, checking the latest values for position and speed and testing these against configurable thresholds.

The incremental cut-off threshold describes the position variance compatible with tolerance setting between the two recording channels A and B on the measuring track unit.

The speed cut-off threshold describes the speed variance compatible with tolerance setting between the two recording channels A and B.

To establish the optimum parameter values for this application, diagnostic functions are available in the SCOPE dialogue within the 'CTSafePro' configuration tool.

The speed is measured using a time measuring function up to 500 Hz (or 500 steps / second) and a frequency measuring procedure above 500 Hz.

**NOTE**

There is a minimum rate of acceleration that the module can detect which is determined by the encoder resolution. The module calculates acceleration from the rate of change of speed and if this rate of change is low, then there will be no change detected between a single clock update. In this situation the result of the acceleration calculation will be either zero or fluctuating.

For this reason, acceleration should not be used as the only parameter for a safety function block. It can be used in conjunction with speed parameters in speed related functions to provide a means of detecting large acceleration rates.

This in turn yields the following characteristic curve for the recording field:

**Figure 3-13 Failure curve velocity measuring**

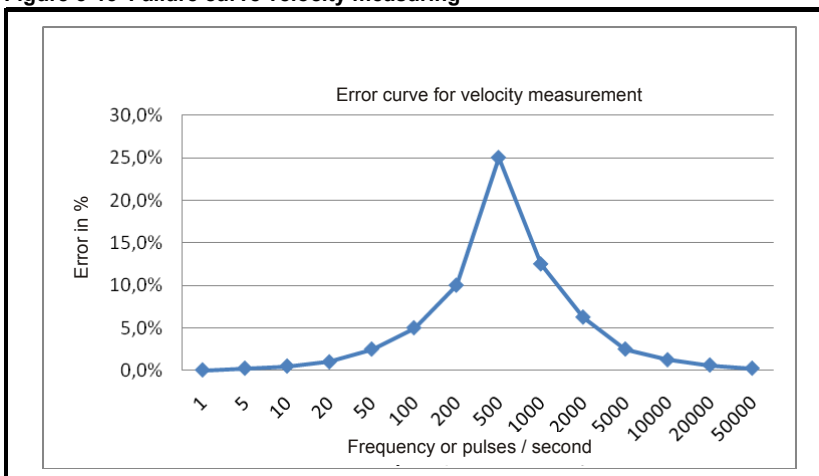

### Safety instructions

- The error rate can be optimized through an appropriate choice of sensor resolution for each given application.
- For applications with limited resolution and/or time variance on the scanning signal, the functional capability of the monitoring function employed can be improved through the use of an average value filter. This average value filter 'smooths' digital interference components from the sensors. However, this is achieved at the expense of slower response times on the system as a whole.
- The filter time constant can be adjusted between 0 and 64 ms in multiples of 8. To establish the response time of the complete system, the filter times need to be added to the response times as detailed in *SI-Safety module response times* on page 45.
- For a technical safety assessment of the sensor sub system, the manufacturer's data (MTTFd, FIT figures etc.) need to be incorporated.
- If the manufacturer requires specific diagnostics to ensure the stated key technical safety indicators, this must be checked with reference to the specific sensor in accordance with Table 3-6 on page 28 'Specific diagnostic measures for position and speed sensors'. If in doubt, clarification will be required from the manufacturer.

Safety Information
Device type
Technical safety features
Installation
SI-Safety module response times
Start-up
Maintenance
Technical data
SI-Safety error types
Encoder types
Validation report
Encoder adaptor
Amendments
Index

- The DC figures quoted in the table, need to be applied in a conservative manner, and compliance with the parameters in Table 3-4 on page 26 (under Comments) need to be implemented.
- The DC value for safety functions with standstill monitoring needs to be established, as in some cases it may be necessary to estimate the frequency of occurrence of the dynamic condition.
- Fault exclusions are permitted in accordance with the applicable standards. Compliance with the parameters listed here must be assured at all times.
- If several sensor systems are required to assure proper function of an individual safety function, always merge their partial values correctly in accordance with the selected procedure. This also applies to a combination of digital and analog sensors (e.g. safely reduced speed with protective door opened = door contact + encoder for speed recording).
- By carefully selecting the resolution for the sensor system, a sufficiently low tolerance can be assured in relation to the applicable disengagement thresholds for individual safety functions.
- When using the encoder input filter, due account must be taken of an extension to response time when evaluating the technical safety function.

### 3.3 Key technical safety indicators and energizing/engagement of the outputs

The SI-Safety module has three safe outputs which can be used individually if required. In addition the module provides two non safe reporting outputs as shown in Table 3-7 below.

**Table 3-7 Non safe outputs**

Output	Architecture in accordance with EN ISO 13849-1:2006	Comment
SBC1, SBC2	4	Complete disengagement channel in accordance with architecture category 4 in accordance with EN ISO 13849-1:2006
STO	4	Complete disengagement channel in accordance with architecture category 4 in accordance with EN ISO 13849-1:2006
A0.1	Not safe	Reporting / auxiliary output
A0.2	Not safe	Reporting / auxiliary output

The safe outputs are subjected to a plausibility test in all operating modes. In their engaged condition, all outputs are subjected to a function test using a cyclical time impulse. To this end, the output is energized for a test period lasting a maximum of 300 µs to the logic low value, i.e. the output is briefly switched to 0 Vdc potential.



## Safety instructions

- For applications involving a frequent request for safety disengagement, tests should be carried out at regular intervals, e.g. at the start of every shift or once a week as deemed necessary. In any event, a test must be carried out at least once every twelve months.
- The test function is always run on safe outputs.
- The auxiliary outputs are not tested.

The outputs can be subjected to the following power ratings as shown in Table 3-8:

**Table 3-8 Output power ratings**

Output	Voltage	Current
A0.1, A0.2	24 Vdc	100 mA
SBC1, SBC2, STO	24 Vdc	500 mA 30 mA



Any external supply must be PELV or SELV. Voltage of connected circuit must not exceed 60 V under working or fault condition. Failure to observe this could cause a loss of the safety function by damage to the digital output circuit.



## Safety instructions

For technical safety applications, only external switch elements with a minimum holding current of > 1.2 mA and a response voltage of >5 V can be used.

A range of diagnostic measures have been implemented for the output system. Customers should be aware of the need to incorporate circuit reinforcement elements such as relays, contactors etc. in the disengagement circuit.

Essentially, these diagnostic measures can be classified in terms of their type and their effectiveness, in accordance with Table 3-9.

**Table 3-9 Diagnostics in the disengagement circuit**

Measure	DC	Comment	Use
Crosscheck of output signals with immediate and interim results in the logic unit (L) and cyclic and logical program runtime monitoring, and detection of static failures and short circuits (on multiple inputs and outputs)	99 %	When using elements to reinforce circuits (external relays or contactors), this is only effective in conjunction with the read back function of switch contacts	Monitoring of outputs with a direct function as a safety switch circuit <b>or</b> Monitoring of safety switch circuits with circuit reinforcement elements in conjunction with the read back function from its outputs

### 3.3.1 Single pole switching output without cross-fault

External contactors can be used for activation of multi phase applications, and/or when higher current levels are required. With regard to single pole activation without external testing, the jamming of one or more external contacts is not detected by the SI-Safety module.



The following example circuit is **NOT** suitable for safety applications!

This output is safe when tested externally.

**Figure 3-14 Single pole switching P output without external testing**

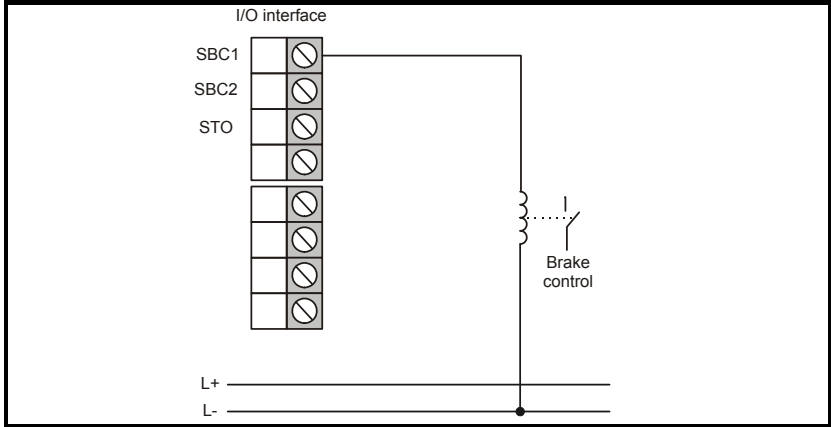

### 3.3.2 Single-pin switching Output with Frequency

**Figure 3-15 Single-Pin switching P-Output with Unidrive M**

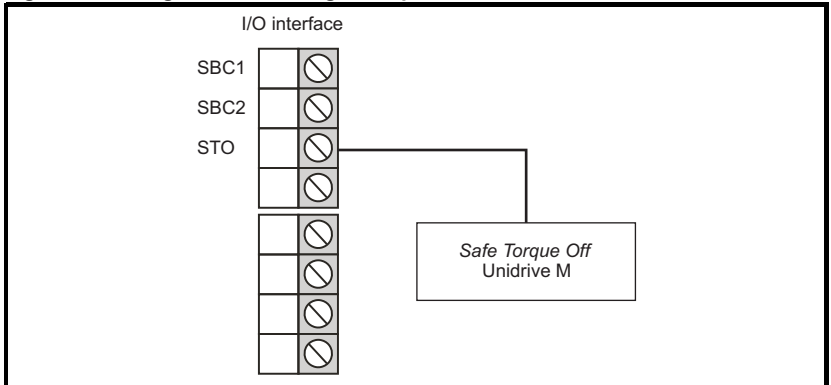

The STO output from the SI-Safety Module can be connected directly to the Safe Torque Off (terminal 31) of a Unidrive M.



The drive Safe Torque Off meets the requirements of the following standards, for the prevention of operation of the motor.

- EN 61800-5-2:2007 SIL 3 (PFH  $\leq 10^{-8}$ )
- EN ISO 13849-1:2006 PL e (MTTFD  $> 10^5$  yr)



It is important to note that a single short-circuit from the Safe Torque Off input to a DC supply of approximately +24 V would cause the drive to be enabled. This can be excluded under EN ISO 13849-2 by the use of protected wiring. The wiring can be protected by providing the wiring with a grounded shield in a positive-logic grounded control circuit. The shield is provided to avoid a hazard from an electrical fault. It may be grounded by any convenient method; no special EMC precautions are required.

If the use of protected wiring is not acceptable, so that the possibility of this short circuit occurring is anticipated, then a relay must be used to monitor the state of the Safe Torque Off input, together with a single safety contactor to prevent operation of the motor after a fault.

### 3.3.3 Two channel switching output with external monitoring

For safety applications for cat 3, PLd in accordance with EN ISO 13849-1:2006, it is required to engage two complementary outputs as a group, thereby activating for example, two external power contactors.

#### NOTE

The SI-Safety module STO output is designed to be connected directly to the drive Safe Torque Off input (terminal 31). This output must be used correctly to prevent the machine from being driven if the module detects a fault.

**Figure 3-16 Two channel switching output with external monitoring on input E0.5 as combined feedback**

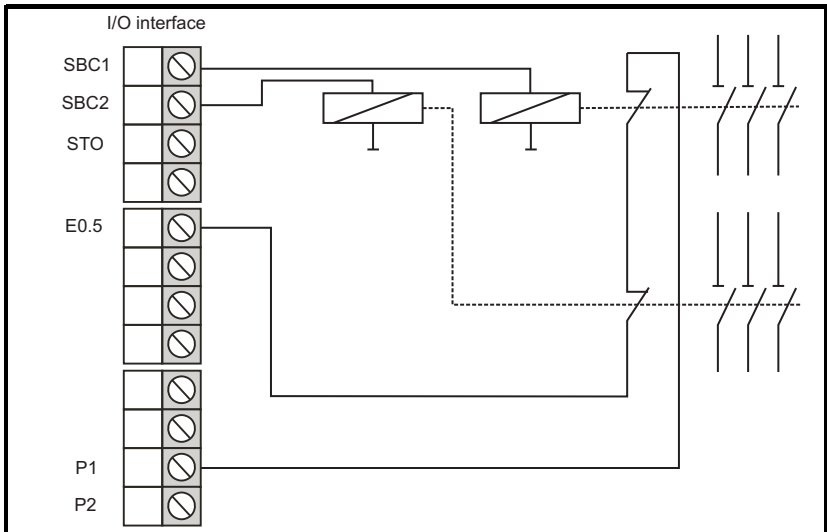

The two external monitoring contacts which are switched in series, receive power from clock signal P1 and are scanned via input 1. Input 1 is used as the read back input, but this function can also be assigned to a different input.

With more demanding requirements, ensure that at least one switch process occurs every 24 hours to test the switching capability of the external power contactor.



### Safety instructions

- For a technical safety assessment of the output subsystem (when using external elements in the disengagement circuit, e.g. to reinforce the circuit), the manufacturer's specifications (MTTF<sub>D</sub>, FIT figures, B10d value etc.) must be used.
- The DC figures quoted in the table need to be applied in a conservative manner, and compliance with parameters (see table under 'Comments') needs to be assured.
- Fault exclusions are permitted in accordance with the applicable standards. Compliance with the parameters listed here must be assured at all times.
- When using circuit reinforcement elements in safety circuits, monitor their function using appropriate read back contacts (see circuitry examples). Suitable read back contacts are forcibly guided or mechanically limited contacts which are linked permanently to contacts in the disengagement circuit.
- The switching capability of external circuit boosters must be tested on a cyclical basis. The period of time between two tests must be defined in accordance with the requirements of the application, and assured by some appropriate course of action. The appropriate course of action can be organizational (disengagement and engagement at the start of a shift etc) or technical (automatic, cyclical engagement) in nature.

### 3.3.4 Auxiliary output circuit

Both the semiconductor outputs implemented on the SI-Safety module can be engaged for functional applications. These outputs are not pulsed.

**Figure 3-17 Auxiliary output circuit**

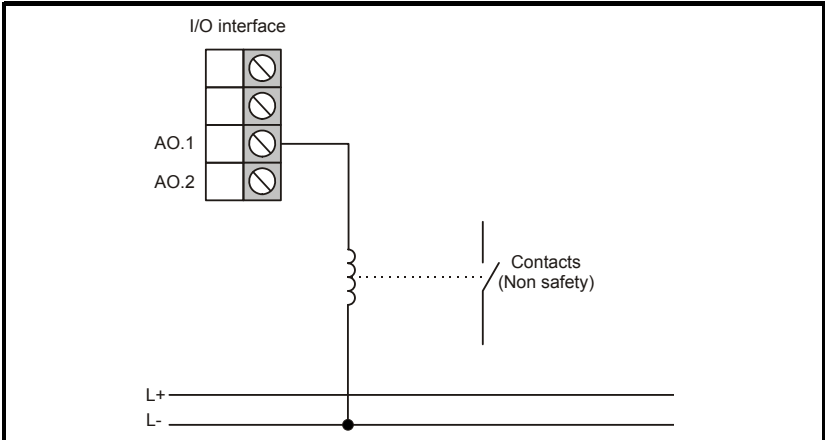

Applications with auxiliary outputs are **NOT** authorized for safety applications!

# 4 Installation

## 4.1 General installation notes

Always follow the safety instructions during installation.

Route all signal cables separately for activation of digital inputs and contact monitoring purposes.

In all cases separate 230 Vac voltages from low voltage lines, if these voltages are being used in conjunction with this application.

Where possible, cable lengths for digital inputs and outputs should not exceed 30 m.

Where cable runs exceed 30 m, take appropriate action to exclude the possibility of faults resulting from un-authorized overvoltage levels. Such action may include avoidance of lightning conductors on external wiring, overvoltage ('spike') protection in internal areas, protected cable routing, i.e. shielding.

The 24V psu and the encoder psu cables should be shorter than 30m, and should not leave the building and should not be connected to a distributed power network.

### Measures relating to electromagnetic compatibility (EMC).

The SI-Safety module is intended for use in a drive unit environment and complies with the aforementioned EMC requirements.

Another prerequisite is that the electromagnetic susceptibility of the entire system must be assured by an appropriate range of similar measures.



### Safety instructions

- The 0V (L- negative pole) must be connected to ground (earth). Failure to observe this could cause a risk of electric shock in the event of an internal fault in the drive.
- Ensure that line power supply cables and 'switching lines' on the inverter are routed separately.
- Signal wires and power lines from the inverter must be routed in separate cable ducts. The ducts themselves should be spaced at least 10 mm apart.
- Always use shielded cabling when connecting position/speed sensors. The cable used to transmit signals must be compatible with the RS-485 standard (twisted pair wiring).
- Ensure that the shielding is connected correctly in the HDMI connector for position and speed sensors. Only metal or metal coated connectors are approved for this purpose.
- Shielding on the sensor side must employ appropriate recognized standards.
- Ensure that all the inverter technology installed in the vicinity of the module is EMC compliant. Pay careful attention to the cable routing and the processing of shielding for the motor wire and connection of the brake resistor. Always ensure compliance with the installation guidelines of the inverter manufacturer.
- All contactors near the inverter must be provided with appropriate protective circuitry.
- Adopt appropriate measures to protect the unit from overvoltage.

Safety Information
Device type
Technical safety features
<b>Installation</b>
SI-Safety module response times
Start-up
Maintenance
Technical data
SI-Safety error types
Encoder types
Validation report
Encoder adaptor
Amendments
Index

## 4.2 Installation and mounting of the SI-Safety module

The module can be mounted on any of the solution module slots on the drive.



The module must be electrically isolated during installation work.



The control circuits are isolated from the power circuits in the drive by basic insulation (single insulation) only. The installer must ensure that the external control circuits are insulated from human contact by at least one layer of insulation (supplementary insulation) rated for use at the AC supply voltage.

## 4.3 Connecting the sensor power supply

The SI-Safety module supports sensor supply voltages of 5 V, 8 V, 10 V, 20 V and 24 V which are monitored internally in accordance with the selected configuration.

For every sensor system, the relevant supply voltage must be connected to the HDMI bush and then configured in accordance with the sensor dialogue for the 'CTSafePro' tool.

The drive can be used to provide the encoder supply (an encoder adapter module is available from Control Techniques to simplify this wiring configuration). Alternatively the supply can be connected directly to an HDMI connector. Refer to Table 4-3 *Encoder interface HDMI* on Page 40

The supply for encoder 2 can alternatively be connected directly to the SI-Safety module I/O connector. Refer to Table 4-2 *Input output interface* on Page 38.

The sensor power supply requires protection of 2 A maximum.

Table 4-1 details the monitoring of the supply voltage in accordance with the selected nominal voltage.

**Table 4-1 Supply voltage monitoring**

Nominal voltage	Minimum voltage	Maximum voltage
5 V	4.4 V	5.6 V
8 V	7 V	9 V
10 V	8 V	12 V
15 V	12 V	18 V
24 V	20 V	29 V

## 4.4 Connection of digital inputs SMF11 to SMF42 and E0.5

The input limitation to PELVSELV devices is:

- DC devices: 120 V
- AC devices: 25 V

The SI-Safety module has four dual channel safety inputs (SMF11/12, 21/22, 31/32, 41/42) and one single channel safety input. These inputs are suitable for the connection of one or two channel inputs with and without clocking action, i.e. without cross-fault checking.

The inputs must have a 'High' level of 24 Vdc (+11 Vdc to +30 Vdc) and a 'Low' level of (-3 Vdc to +5 Vdc, Type 1 in accordance with EN 61131-2). These inputs are provided with internal input filters.

A diagnostic function inside the device performs a cyclic check to ensure that all inputs, including the input filter, are functioning correctly. Should a fault be detected, the SI-Safety module switches into alarm status. At the same time all outputs on the SI-Safety module are switched to 'passive' mode, i.e. disabled.

In addition to the actual signal inputs, the SI-Safety module provides two clocking outputs, P1 and P2 configured as 24 Vdc switching outputs.

These clocking outputs are provided solely for monitoring digital inputs (SMF and E0.5) and cannot be used for any other function within the application.

The switching frequency is 125 Hz for every clocking output. During initial system design, ensure that the clocking outputs can never be subjected to a current in excess of 100 mA.

Approved OSSD outputs can be connected without restriction to the inputs.

Care must be taken to ensure that the possibility of a short circuit in the external wiring between the various inputs and the power supply of the SI-Safety module is eliminated by the use of appropriate cable ducting.

Every input on the SI-Safety module can be configured individually for the following signal sources:

- Input is assigned to Pulse P1
- Input is assigned to Pulse P2
- Input is assigned to 24 Vdc continuous voltage
- Proxi input only E0.5 (individual input)

In terms of its architecture and operating strategy, the internal structure of the SI-Safety module series must comply with Category 4 of EN ISO 13849-1:2006. Every input features the following internal architecture:

The following circuits are examples for connecting inputs:

Signal processing in two channels, and diagnosis through cross checking in the PES

**Figure 4-1 Signal processing in two channels**

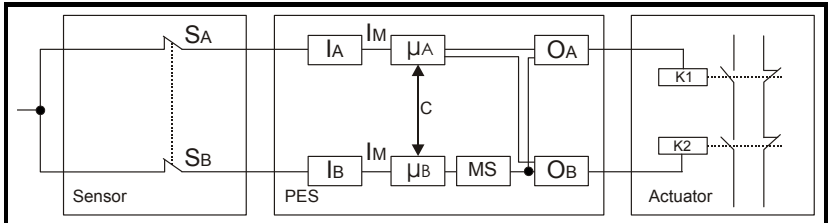

Dual scanning and signal processing in two channels, diagnosis through cross checking in the PES.

**Figure 4-2 Dual scanning and signal processing in two channels**

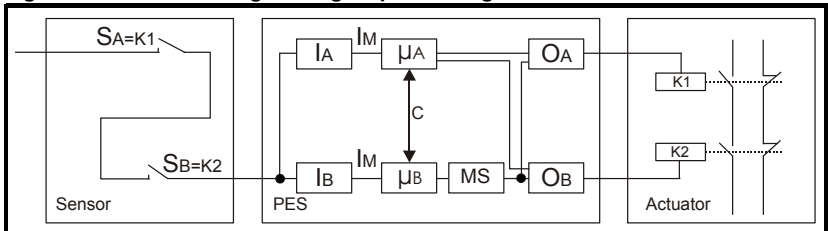

Safety Information
Device type
Technical safety features
Installation
SI-Safety module response times
Start-up
Maintenance
Technical data
SI-Safety error types
Encoder types
Validation report
Encoder adaptor
Amendments
Index

**Table 4-2 Input output interface**

Terminal	Designation	Function
1	SMF11	Digital IN SMF11
2	SMF12	Digital IN SMF12
3	SMF21	Digital IN SMF21
4	SMF22	Digital IN SMF22
5	SMF31	Digital IN SMF31
6	SMF32	Digital IN SMF32
7	SMF41	Digital IN SMF41
8	SMF42	Digital IN SMF42
9	E0.5	Digital IN E0.5
10	P1	Clocking output P1
11	P2	Clocking output P2
12	STO	HISIDE output STO
13	SBC1	HISIDE output SBC1
14	SBC2	HISIDE output SBC2
15	A0.1	Signal and auxiliary output A0.1
16	A0.2	Signal and auxiliary output A0.2
17	L-ENC 1/2	Sensor power supply for sensor interface GND ENC 1/2
18	L+ENC2	Sensor power supply for sensor interface SUPPLY ENC2

Permitted wire dimensions 0.2 mm<sup>2</sup> minimum, 1 mm<sup>2</sup> maximum.

**Figure 4-3 Encoder interface**

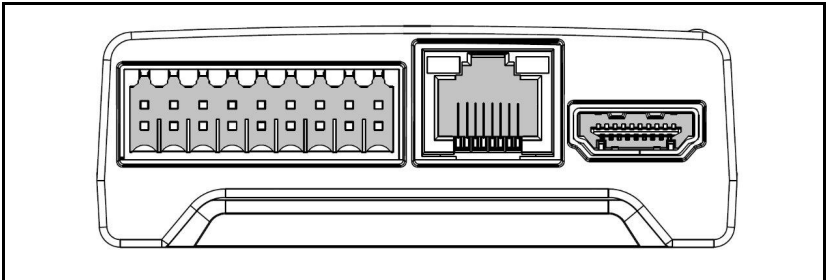

## 4.5 Connecting position and speed sensors

### 4.5.1 General notes

The SI-Safety module provides two sensor interfaces to enable connection to industry standard incremental and absolute encoders. The encoder interfaces can be configured as incremental, SIN/COS, or absolute SSI sensors.

In addition, connection to other sensors which generate incremental signals (i.e. proximity switches) to input E0.5 of the SI-Safety module are also possible.

An encoder adapter module is available from Control Techniques to simplify the connections of the encoders. If a single SinCos or incremental encoder is used then the encoder signals must be connected to both encoder 1 and encoder 2 connections on the HDMI cable.



The power supply to the sensor system can be connected via the terminal specified on the SI-Safety module. This voltage is directed to the sensor connector where it is monitored by an internal diagnostic process.

If the sensor receives its power from an external source, that voltage needs to be routed via the sensor connector. This allows the corresponding terminal (sensor power supply) on the module to remain free.

If an external sensor power supply is not routed back through the sensor connector, any failure of this power supply needs to be incorporated in the fail-safe arrangements for the system as a whole. In particular, verification is required that this fault can be detected and/or eliminated whenever the power supply to the sensor system is either above or below specified limits.

The external power supply must meet the requirements of PELV/SELV.

#### NOTE

- When a single encoder is used the SI-Safety module employs two methods of evaluating the encoder signals. If the difference between the two evaluations exceeds the threshold then an alarm will be produced. Appropriate measures must therefore be taken when connecting the encoders to minimise any electrical interference otherwise intermittent alarms could be triggered. It is advisable to follow the EMC guidelines in the *Unidrive M Drive User Guide*.
- Consideration should be given to EMC measures including layout, shielding and shielding.
- Both sensors must be free of reciprocal feedback, i.e. each must function independently of the other. This applies equally to the electrical and mechanical sections.
- If both sensors are linked via shared mechanical components to the monitoring unit, that connection must be configured for positive contact and must not include any component parts which may be liable to wear i.e. chains, toothed belts etc. If such parts are included, additional monitoring units will be required for the mechanical connection between the sensors (e.g. monitoring of a toothed belt).
- For active position processing purposes, at least one absolute encoder must be used.
- When using two equivalent sensors, always ensure that the sensor with the higher resolution level is configured as Sensor one (process sensor), while the sensor with the lower resolution level must be configured as Sensor two (reference sensor).
- If the appropriate measures to reduce electromagnetic interference are not correctly implemented the spurious speed difference/position difference trips may occur. This is more likely if the speed is below 10 rpm.

Safety Information
Device type
Technical safety features
Installation
SI-Safety module response times
Start-up
Maintenance
Technical data
SI-Safety error types
Encoder types
Validation report
Encoder adaptor
Amendments
Index

- For the data and clock signals, and/or track A and track B, twisted pair wiring must be used for signal transmission to comply with RS485 standards. When selecting a suitable cross sectional cable area, consideration should be given to the power consumption of the encoder, and to the length of cable used for each individual installation.
- With regard to the use of absolute encoders, the following points also apply:

In Slave mode, the clocking signal is generated by an external process, and is scanned together with the data signal from the SI-Safety module. This kind of scanning causes a degree of 'floating action' which in turn gives rise to a scanning error of the following magnitude:

$$F = ( \text{sensing time of sensor from external system [ms]} / 8 \text{ [ms]} ) * 100 \%$$

The level of the resultant scanning error **F** must be taken into account when defining the thresholds in the monitoring functions employed as this error cannot be compensated for.

**Table 4-3 Encoder interface HDMI**

Pin	Designation	Encoder	Function
1	A+(COS+)/DATA+	ENC1	Incremental track A+ / data wire DATA+
2	SHIELD		
3	A-(COS-)/DATA-	ENC1	Incremental track A- / data wire DATA-
4	B+(SIN+)/CLK+	ENC1	Incremental track B+ / data wire CLOCK+
5	SHIELD		
6	B-(SIN-)/CLK-	ENC1	Incremental track B- / data wire CLOCK-
7	A+(COS+)/DATA+	ENC2	Incremental track A+ / data wire DATA+
8	SHIELD		
9	A-(COS-)/DATA-	ENC2	Incremental track A- / data wire DATA-
10	B+(SIN+)/CLK+	ENC2	Incremental track B+ / data wire CLOCK+
11	SHIELD		
12	B-(SIN-)/CLK-	ENC2	Incremental track B- / data wire CLOCK-
13	L+	ENC1	Power supply for SUPPLY sensor interface
14	L+	ENC1	Power supply for SUPPLY sensor interface
15	L-	ENC1/2	Power supply for GND sensor interface
16	L-	ENC1/2	Power supply for GND sensor interface
17	L+	ENC2	Power supply for SUPPLY sensor interface
18	L+	ENC2	Power supply for SUPPLY sensor interface
19	NC		



Figure 4-4 Encoder connection detail

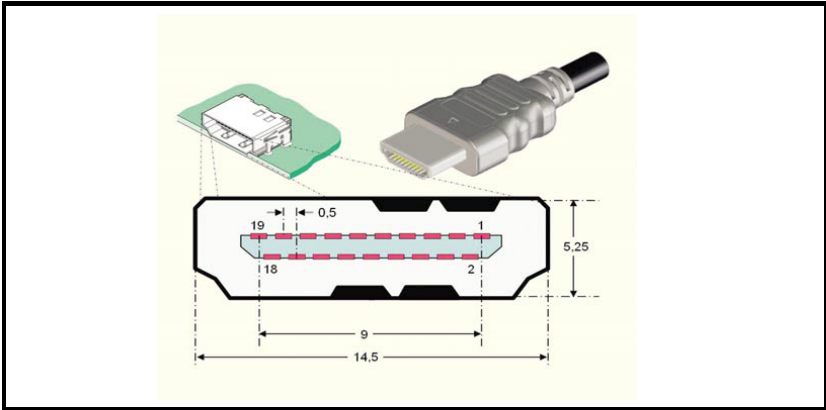

## 4.6 Connecting the proximity switch

Connection via the I/O interface on digital input E0.5

## 4.7 Combining different types of encoder

With regard to applications with encoder systems, please note that due to the monitoring features implemented in the SI-Safety module range, it does not impose any special requirements on the internal configuration of the encoder electronics, i.e. as a rule, it is possible to work with standard sensors.

However, the following restrictions do apply:



### Safety instructions

- SIN/COS encoder: The internal layout of the sensor system must be designed in such a way that it enables output signals on both tracks to be generated independently of one another, thereby eliminating the possibility of commonly caused faults. Furthermore, the mechanical configuration must be verified, e.g. mounting of the code disc to the shaft. Sensors with appropriate verifications and test reports are available on the market.
- Compact encoder with 2 x SSI or SSI + incremental: Here also verification is required to ensure that the two inner encoder units are feedback free, including the internal mechanical configuration.
- When using just one encoder (e.g. compact sensor), the fault exclusion parameter must be in place for 'shaft break / fault in the mechanical encoder connection'. To this end, appropriate steps need to be taken, e.g. positive connection of the sensor using groove-wedge or retaining pin.

**The SI-Safety module is able to detect the following faults in the external encoder system:**

- Short circuits between the safety-related signal lines
- Open circuits on the safety-related signal lines
- 'Stuck at 0' or 'stuck at 1' on one or all safety-related signal lines

Additional specific diagnostics for fault detection in the external encoder system are assigned to each type of sensor. The relevant diagnostic measures are itemised below for the individual sensor types, together with their boundary parameters.



### **Safety instructions**

- The diagnostic measures naturally tend to point towards tolerances resulting from measuring inaccuracies. These tolerances need to be considered during the technical safety assessment.
- Some of the limiting values for these diagnostic measures can be configured, while others are strictly specified. The resultant diagnosis coverage levels need to be evaluated in an application based context, and incorporated in the overall technical safety assessment.

## **4.8 Configuration of measuring routes**

The most important input parameters for the monitoring functions of the module are:

- Safe position
- Speed
- Acceleration

These are generated on a two channel basis from the connected sensor systems. For PL e in accordance with EN ISO 13849-1:2006, architecture corresponding to Category 4 is required, i.e. continuous two channel recording with a high level of diagnostic cover. For any single channel components (e.g. mechanical connection of sensor/encoder with just one shaft/mounting), it may be possible to employ fault exclusions in accordance with EN ISO 13849-2 as a basis. For PL d in accordance with EN ISO 13849-1:2006, it is possible to work with a reduced level of diagnostic coverage. Taking due account of the permitted fault exclusions defined in EN ISO 13849-1:2006, it may also be possible to use sensor systems which only feature a simple configuration (e.g. ones with only speed monitoring capability).

Other aspects of the configuration are described in *CTSafePro help*.

### **4.8.1 Type of sensor**

Absolute encoders and incremental measuring systems can be used, in addition to proximity switches which generate/count pulses.

## 4.8.2 Absolute encoder

**Table 4-4 Absolute encoder**

Data interface	Serial Synchronous Interface (SSI) with variable data length of 12 to 28 bits.
Data format	binary or graycode
Physical layer	RS-422 compatible
<b>SSI master operation</b>	
Clock speed	see Table 2-2 <i>Key technical indicators</i> on page 16
<b>SSI listener operation (slave mode)</b>	
Max. External clock speed	Table 2-2 <i>Key technical indicators</i> on page 16.
Min. clock pause time	30 ns
Max. clock pause time	1 ms

## 4.8.3 Diagnostics absolute encoder

**Table 4-5 Absolute encoder diagnosis**

Diagnosis	Parameter(s)	Fault threshold
Monitoring of power supply	Fixed values 5 V, 8 V, 10 V, 20 V, 24 V	±20 % (measuring tolerance)
Monitoring of differential level at input	Fixed value of RS 485 level	±20 % (measuring tolerance)
Plausibility of speed versus position	Fixed value	$\Delta P < 2 * V * T$ with T = 8 ms

## 4.8.4 Configuring the SSI format

The CT inverter only delivers SSI signals with right justified data bit arrangement (i.e. no status bits before the data bits).

The SI-Safety module board can only be configured to a maximum of 28 data bits, the configuration options cover the CT SSI format.

Figure 4-5 illustrates the options for the SI-Safety module board. For the CT inverter, the appropriate SSI format must be configured in the 'CTSafePro' software.

**Figure 4-5 Configuring the SSI format**

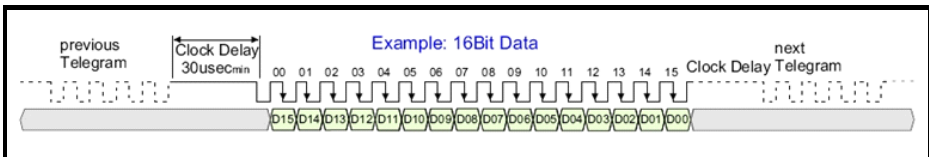

## 4.9 Incremental sensor:

Physical layer: RS-422 compatible

Measuring signal A/B: Track with 90 ° phase difference

Maximum frequency of the input cycles: see Table 2-2 *Key technical indicators* on page 16.

**Table 4-6 Diagnosis: Incremental encoder**

Diagnosis	Parameter(s)	Fault threshold
Monitoring of power supply	Fixed values 5 V, 8 V, 10 V, 20 V, 24 V	±20 % (measuring tolerance)
Monitoring of differential level at input	Fixed value of RS 485 level	±20 % (measuring tolerance)
Monitoring of the count signal separately for each track A/B	Fixed value	DP > four increments

### 4.9.1 Sine-cosine sensor standard mode

Physical layer: ±0.5 V<sub>SS</sub> (without voltage offset)

Measuring signal A/B: Track with 90 ° phase difference

Maximum frequency of the input cycles, see Table 2-2 *Key technical indicators* on page 16.

**Table 4-7 Diagnosis: Sine - cosine encoder**

Diagnosis	Parameter(s)	Fault threshold
Monitoring of power supply	Fixed values 5 V, 8 V, 10 V, 20 V, 24 V	±20 % (measuring tolerance)
Amplitude monitoring SIN <sup>2</sup> +COS <sup>2</sup>	Fixed value 1V <sub>SS</sub>	65 % of 1 V <sub>SS</sub> ±2.5 % (measuring tolerance)
Monitoring of phase A/B	Fixed value 90 °	±30 ° measuring tolerance)

### 4.9.2 Proxi switch

Signal level: 24 V / 0 V

Maximum count impulse frequency see Table 2-2 *Key technical indicators* on page 16.

Switch logic de-bounced

**Table 4-8 Diagnosis: Proxi switch**

Diagnosis	Parameter(s)	Fault threshold
Monitoring of power supply	Fixed values 5 V, 8 V, 10 V, 20 V, 24 V	±20 % (measuring tolerance)

# 5 SI-Safety module response times

## 5.1 SI-Safety module response times

Response time is an important technical safety property and needs to be taken into account with every application / application based or applied safety function.

This chapter details the response times for individual functions in relation to other parameters. In cases where quoting these details is not sufficient for a specific application, specific measurements need to be made to validate the actual time characteristics are acceptable within nominal characteristics. This is especially true in respect of the use of filter functions.



### Safety instructions

The response times must be defined in the nominal characteristics for each applicable safety function and must then be compared against the actual value with the help of the following details.

- Particular caution is advisable when using filter functions. Depending on filter length and time, the response time can be extended substantially and this fact should always be taken into consideration when configuring the technical safety functions.
- With particularly critical task profiles, the time characteristics need to be validated by means of measurements.
- During start up, all inputs and outputs remain disabled until the start up tests have been (successfully) passed. Errors and faults at the inputs will be checked after start up, so the device will go to alarm or error state after a short delay.

## 5.2 Response times for response in standard operating mode

The basis for calculating response times is the cycle time of the SI-Safety module system. During operation, this equates to  $T_{\text{cycle}} = 8 \text{ ms}$ . The response times indicated equate to the maximum run time for any specific application within the SI-Safety module. In order to obtain the total application run time, all application dependent response times of one safety function loop need to be summed.

Safety Information
Device type
Technical safety features
Installation
<b>SI-Safety module response times</b>
Start-up
Maintenance
Technical data
SI-Safety error types
Encoder types
Validation report
Encoder adaptor
Amendments
Index

**Table 5-1 Response time standard operating mode**

Function	Response time ms	Explanation
Activation of a monitoring function using ENABLE followed by switching off using a digital output	24*	Activation of a monitoring function by the ENABLE signal.
Response from a monitoring function which has already been enabled, including PLC processing via digital output for position and speed processing operations.	16*	In cases where a monitoring function has already been activated with ENABLE, the module requires one cycle in order to calculate the prevailing speed value. In the next cycle, after calculating the monitoring function, the PLC uses the information for further processing and output purposes, i.e. after the logic function has been implemented, this causes an output to switch/engage.
Activation of a digital output via a digital input	16	Activation of an input and switching of an output
Deactivation of a digital output via a digital input	16	Deactivation of an input, and corresponding deactivation of the output
Average value filter (setting: refer to sensor dialogue 'CTSafePro')	0 - 64	Group run time of the average value generator. This run time only acts on monitoring functions in conjunction with position and speed acceleration, but has no effect on logic processing.

**NOTE** \* When using an average value filter, this response time needs to be added in.

**NOTE** The maximum response time for the drive Safe Torque Off is 20 ms.

### 5.3 Response times for FAST\_CHANNEL



FAST\_CHANNEL designates a property of an SI-Safety module, whereby it responds more rapidly to speed requirements than is possible when processing safety programs in the normal cycle = 8 ms. The scanning time for FAST\_CHANNEL is 2 ms.

The worst case response time is 4 ms.



#### Safety instructions

- When using FAST\_CHANNEL, ensure that disengagement within the aforementioned time can happen for a specified speed threshold if the sensor information has sufficiently high resolution. The smallest resolution of switch threshold for FAST\_CHANNEL requires at least two flank changes on the selected sensor system, and those changes must occur within a period of 2 ms.
- This function is only possible when used with semiconductor outputs.

## 5.4 Response times for fault distance monitoring

To calculate the worst case scenario, use the following calculations:

**System speed at scanning time:  $V(t)$**

**System speed for module response:  $VA(t)$**

**Threshold value for monitoring (SLS or SCA):  $VS = \text{constant for all } t$**

**Configured filter value:  $XF = \text{constant for all } t$**

**Max. Possible acceleration for the application:  $a_F = \text{constant for all } t$**

**Retardation after disengagement:  $a_V = \text{constant for all } t$**

**Scanning time for occurrence of a worst case event:  $T_{\text{fault}}$**

**Module response time:  $T_{\text{response}}$**

For the worst case scenario, it is assumed that the drive unit initially moves at a speed of  $v(k)$ , precisely in line with the configured threshold of  $V_0$ , then accelerates at a maximum possible value of  $a_0$ .

**Figure 5-1 Characteristics of drive unit with and without linear ramp and overspeed distance**

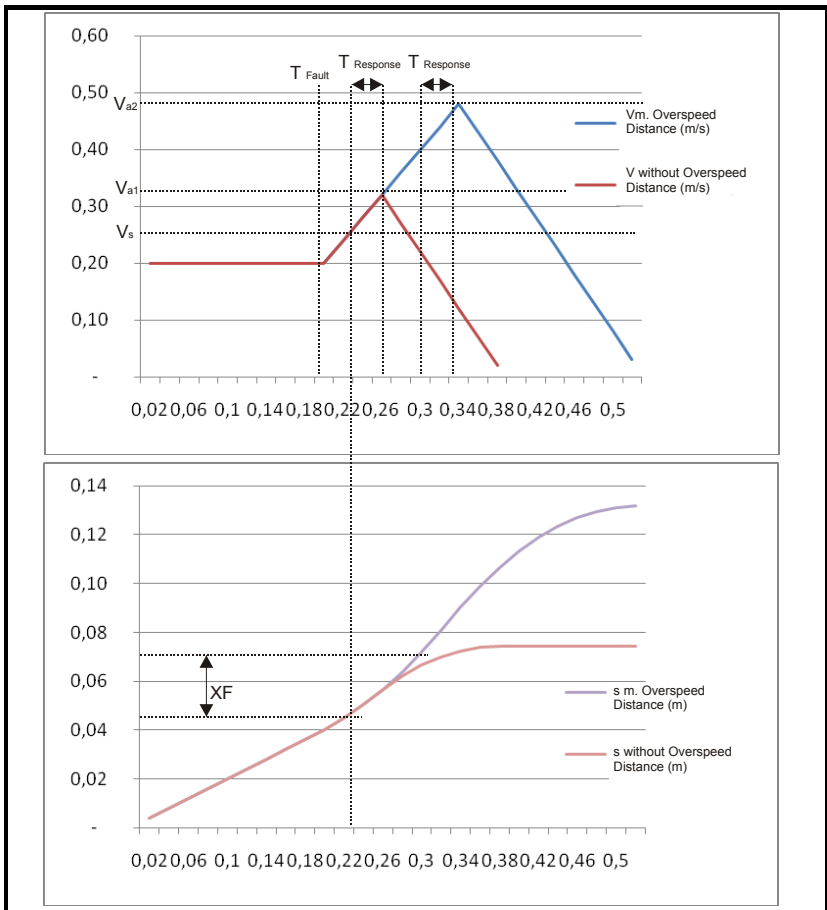

For characteristics curve and s with overspeed distance, the following applies:

**Table 5-2 Relationships with overspeed distance**

Parameter(s)	Calculation procedure	Comment
$T_{\text{response}}$	Value from response time figure + retardation time in external disengagement chain	Retardation time in external disengagement chain, derived from details from manufacturer of relay, contactor, brake, etc.
$a_F, a_V$	Not applicable	Estimate from application
$V_{a2}$	$= a_F * t_{\text{response}} + (V_S^2 + 2 * a_F * XF)^{1/2}$	

For characteristics curve V and s, the following relationships occur without overspeed distance:

**Table 5-3 Relationships without overspeed distance**

Parameter(s)	Calculation procedure	Comment
$T_{\text{response}}$	Value from response time figure + retardation time in external disengagement chain	Retardation time in external disengagement chain, derived from details from manufacturer of relay, contactor, brake, etc.
$a_F, a_V$	n.a.	Estimate from application
$V_{a1}$	$= V_S + a_F * t_{\text{response}}$	

The filter action moves the set speed threshold of  $V_a$  upwards by an amount of **delta\_v\_filter**. Consideration must also be given to the new figures for response time ( $T_{\text{react}} = T_{\text{smx}} + T_{\text{filter}}$ ), as well as of the resultant speed when disengaged by the module.



# 6 Start-up

## 6.1 Procedure

Start-up / commissioning must only be performed by suitably trained and skilled personnel. Observe all safety instructions during start-up / commissioning.

### 6.1.1 LED display

Following a reboot, the following sequences run whenever a session is completed without faults being reported. The result is displayed on the front panel LED display.

**Table 6-1 Key to LED display**

Mode	Description	LED display
Start-up	Synchronization between the two processor systems and checking of the configuration and firmware data	Off
RUN	Normal operation of the system. All outputs are switched to reflect the prevailing status of the logic unit.	Flashing green (1 Hz)
STOP	In Stop mode, parameter and program data can be loaded externally.	Flashing red/green (1 Hz)
ALARM	Alarm can be reset by digital input.	Flashing red /yellow (1 Hz)
Fault	Fault can only be reset by power cycling.	Continuous red
Not validated	System running but not validated	Flashing yellow (1 Hz)

## 6.2 Configuration

Configuration is performed using the '*CTSafePro*' program. To be able to transmit data to the module, a programming adapter is required, and its drivers need to be installed before it is used for the first time.

*CTSafePro* is a graphical PC tool which enables the configuration of the speed encoder interface, definition of the safe motion functionality and logic operations. It also provides testing and advanced diagnostic tools.

The configuration is saved and protected against line power failure within the module. Refer to *CTSafePro help* for details of how to configure the SI-Safety module.

### 6.2.1 Downloading the configuration to the SI-Safety module

The configuration is downloaded to the SI-Safety module via a serial cable connected between the PC and the SI-Safety module RJ45 port. Refer to *CTSafePro help* for details of downloading the configuration.



An isolated serial communications cable must be used to connect the SI-Safety module to IT equipment (i.e. laptop computers). Suitable cables are available from Control Techniques.

### 6.3 Function test

To assure the safety of the module, perform a function test of safety functions once a year. This involves testing the function and/or disengagement capability of the modules used during configuration work (inputs, outputs, monitoring functions and logic modules). See also *CTSafePro help*.

### 6.4 Validation

To ensure that safety functions have been implemented, the user needs to check and document parameters and links on completion of the start-up and configuration process. This is supported by the validation assistant in the programming user interface as detailed in Section 6.5.

The validation report details are described in Chapter 11 *Validation report* on page 82.

### 6.5 Technical safety test

On completion of start-up / commissioning, installers must ensure that the relevant safety functions have been implemented, and that parameters and links have been documented.

This process is supported by the 'CTSafePro' configuration software validation report (see Chapter 2 *Device type* on page 15). The first two header pages give general details about the system and require manual data entry. The last header page contains individual verification of the technical safety test.

**It is essential that the label details as shown in Figure 2-1 on page 17 are recorded.**

The person responsible for testing the safety module should also confirm that the CRC displayed on the programming user interface is identical to the CRC stored in the SM-Safety module.

The report also includes the PLC listing and details of the sensor, input/output and function block configuration.

After transmitting the configuration and program data to the SI-Safety module, the status LED flashes yellow. This indicates that the configuration data have not yet been validated. By confirming with the 'BLOCK CONFIGURATION' button at the end of the validation dialogue, the data are marked as 'validated' and the LED flashes green.

# 7 Maintenance

## 7.1 Modification

### Repair

This device can only be repaired by the original manufacturer.

### Warranty

The warranty is void if the module is opened.



The safety approval is void if the module is modified.

## 7.2 Module replacement

Note the following when replacing a module:

- Disconnect the inverter from the line power supply.
- Disconnect power supply from the device and remove the connection.
- Remove the sensor connector.
- Remove all other plug type connections.
- Remove module from top hat rail and package in an EMC compliant manner.
- Install a new module to the top hat rail.
- Remake all connections.
- Switch on the inverter.
- Switch on the power supply.
- Configure the device.



Under no circumstances should any plug type connection on the SI-Safety module be disconnected or reconnected while power is applied to the device, as there is a risk of failure or permanent destruction of the connected position and/or speed sensors.

## 7.3 Maintenance intervals

Table 7-1

Module replacement	See Technical Data Section 2-2 <i>Key technical indicators</i> page 16.
Function test	See 'Start-up' chapter

## 7.4 Diagnostic parameters

The SI-Safety module is designed to accept predefined data during operation. A fully assigned patch cable for connecting the SI-Safety module (RJ45) and the Unidrive M (RJ45) is required. The data to be transferred are defined in *CTSafePro*. The configuration of the signal channel data is defined as shown in Table 7-1.

**Figure 7-1 Configuring the data format**

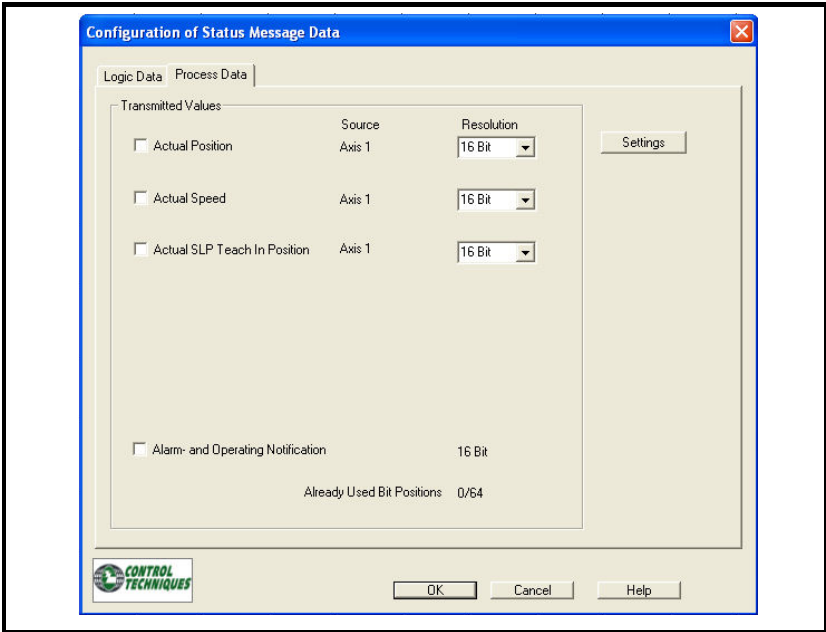

The user may define all aspects of the data including speed, position and logic data, plus switching conditions of logic elements on the terminal interface. Processed data is subsequently displayed in registers in menu 20 on the drive.

The processed data is displayed in the row below and is limited to a total of 64 bits with the current position of axis 1 appearing in Pr **20.021**. If the current speed of axis 1 is also required, this value is displayed in Pr **20.022**.

Communication with the drive is performed automatically after the data cable is connected to the unit. The peripheral devices are activated through Baud rate and serial addresses in the *CTSafePro* with the data being sent in cyclic format.

**NOTE**

The following drive parameters must be set to their default parameters for communication to occur between the drive and the SI-Safety module.

- Pr **11.023** = 1
- Pr **11.024** = rtu
- Pr **11.025** = 19200

With the RJ45 data cable connected between the SI-Safety module and the drive, the following diagnostic parameters are displayed. The transmitted register in menu 20 is allocated as shown in Table 7-2 below.

**Table 7-2**

Parameters	Status
<b>Pr 20.012 - Pr 20.014</b>	<b>Information data</b>
Pr 20.12	Module identification number (16 Bit)
Pr 20.13	Firmware version (8 Bit)
Pr 20.14	Identifier of application software (8 Bit)
<b>Pr 20.015 - Pr 20.020</b>	<b>Logic data</b>
Pr 20.015	Logic data (8 Bit)
Pr 20.016	Logic data (8 Bit)
Pr 20.017	Logic data (8 Bit)
Pr 20.018	Logic data (8 Bit)
Pr 20.019	Logic data (16 Bit)
Pr 20.020	Logic data (16 Bit)
<b>Pr 20.021 - Pr 20.024</b>	<b>Process data</b>
Pr 20.021	Process data (16 Bit)
Pr 20.022	Process data (16 Bit)
Pr 20.023	Process data (16 Bit)
Pr 20.024	Process data (16 Bit)

Safety Information
Device type
Technical safety features
Installation
SI-Safety module response times
Start-up
<b>Maintenance</b>
Technical data
SI-Safety error types
Encoder types
Validation report
Encoder adaptor
Amendments
Index

## Expanded description of individual parameters

<b>20.012</b>		<b>Module identification number</b>	
Explanation	Pr <b>20.012</b> is a permanently assigned module code and specially defined for SI-Safety. The module is therefore labelled in its hardware and also identifiable in connected status.		
Operating mode	OL, CL, Servo		
Range	0 to +32767		
Default	801		
Update	19,200 Baud		
Format	16 Bit		
<b>20.013</b>		<b>Firmware version</b>	
Explanation	The version number of the module firmware is displayed here. The display is numerical only. For version 2.0.2.18, "20218" is displayed.		
Operating mode	OL, CL, Servo		
Range	0 to +32767		
Default	0		
Update	19,200 Baud		
Format	16 Bit		
<b>20.014</b>		<b>Application software identification</b>	
Explanation	The loaded application software displays a counter, which counts from 0 to 255. The display is numerical only and indicates to the user that the module is connected to the right drive controller via the serial port and is running correctly.		
Operating mode	OL, CL, Servo		
Range	0 to 255		
Default	0		
Update	19,200 Baud		
Format	8 Bit		

<b>20.015 - 20.020</b>	<b>Logic data</b>	
Explanation	Here, the defined logic data is displayed as configured in <i>CTSafePro</i> .	
<b>20.015</b>	<b>Operating mode</b>	
Explanation	Display Bit 64 to Bit 57 of logic data Here, the different operating modes are displayed. 1 Start-up 2 SendConfig 3 Start-upBus 4 Run 5 Stop 6 Error 7 Alarm	
Operating mode	OL, CL, Servo	
Range	0 to 7	
Default	0	
Update	19,200 Baud	
Format	8 Bit	
<b>20.016</b>	<b>Diagnostic expansion 2</b>	
Explanation	Display Bit 56 to Bit 49 of logic data	
Operating mode	OL, CL, Servo	
Range	0 to 255	
Default	0	
Update	19,200 Baud	
Format	8 Bit	

Safety information
Device type
Technical safety features
Installation
SI-Safety module response times
Start-up
Maintenance
Technical data
SI-Safety error types
Encoder types
Validation report
Encoder adaptor
Amendments
Index

<b>20.017</b>	<b>Diagnostic expansion 1</b>	
Explanation	Display Bit 48 to Bit 41 of logic data	
Operating mode	OL, CL, Servo	
Range	0 to 255	
Default	0	
Update	19,200 Baud	
Format	8 Bit	
<b>20.018</b>	<b>Diagnostic expansion 0</b>	
Explanation	Display Bit 40 to Bit 33 of logic data	
Operating mode	OL, CL, Servo	
Range	0 to 255	
Default	0	
Update	19,200 Baud	
Format	8 Bit	
<b>20.019</b>	<b>Diagnostic 0</b>	
Explanation	Display Bit 16 to Bit 1 of logic data	
Operating mode	OL, CL, Servo	
Range	0 to +32767	
Default	0	
Update	19,200 Baud	
Format	16 Bit	
<b>20.020</b>	<b>Diagnostic 1 or error / alarm code</b>	
Explanation	<p>Display Bit 31 - Bit 17 of logic data</p> <p>Either diagnostic data, error or alarm codes are displayed depending upon the operating mode shown in Pr <b>20.015</b>. In the event of an alarm and then an error occurring, the following priority applies:</p> <p>Priority 1 error display  Priority 2 alarm display  Priority 3 encoder alarm display</p>	
Operating mode	OL, CL, Servo	
Range	0 to +32767	
Default	0	
Update	19,200 Baud	
Format	16 Bit	



20.021 - 20.023		Process data	
Explanation	Pr 20.021 - Position Pr 20.022 - Speed Pr 20.023 - SLP teach in position Pr 20.024 - Alarm code		
Operating mode	OL, CL, Servo		
Range	-2 <sup>31</sup> to 2 <sup>31</sup> -1		
Default	0		
Update	19,200 Baud		
Format	16 Bit		

## 7.5 Input / output status indication

The input/output status can be displayed in the *CTSafePro* or via configuration of the logic data in Pr 20.016 to Pr 20.020.

## 7.6 Software diagnostics

Refer to *CTSafePro help*.

Safety information
Device type
Technical safety features
Installation
SI-Safety module response times
Start-up
Maintenance
Technical data
SI-Safety error types
Encoder types
Validation report
Encoder adaptor
Amendments
Index

---

## 8 Technical data

---

### 8.1 Environmental conditions

**Table 8-1 Environmental conditions**

Protection class	IP 20
Ambient temperature	0 °C to 50 °C
Climate class	3 in accordance with EN 50178:1998
Service life	90,000 hours at 50 °C ambient temperature

### 8.2 Key technical safety indicators

**Table 8-2 Key technical safety indicators**

Maximum achievable safety class	SIL 3 in accordance with EN 61508 Cat 4, PL e in accordance with EN ISO 13849-1:2006
System structure	Two channel with diagnosis (1oo2)
Configuration of operating mode	'high demand' in accordance with EN 61508 (high demand rate)
Probability of a potentially dangerous failure on an hourly basis (PFH figure)	see Table 2-2 <i>Key technical indicators</i> on page 16.
Proof Test Interval (EN 61508)	20 years, then the module needs to be replaced



The module must be installed in an IP54 rated enclosure.

# 9 SI-Safety error types

## 9.1 SI-Safety error types

SI-Safety makes a distinction between two types of error as shown in Table 9-1.

**Table 9-1 Distinction between fault types**

Type of error	Description	Impact on system	Reset condition
Fault	Serious exception error caused by program running in SI-Safety. Cyclical program runtime no longer possible due to technical safety reasons. Display by system A. System B is in Stop mode.	All outputs are switched off.	Can be reset by switching SI-Safety on/off.
Alarm	Functional error caused by an external process. Both systems continue running in a cyclic manner to service all requirements of the communication interfaces. Scanning of the external process is also maintained.	All outputs are switched off.	Reset by configurable input
Encoder supervision (ECS) alarm	When using the ECS function, outputs are not switched off when an encoder alarm is triggered.	ECS function block delivers '1' as a result	Reset by configurable input

Detection of errors in System A and System B:

- System A: odd numbers
- System B: even numbers

Safety Information
Device type
Technical safety features
Installation
SI-Safety module response times
Start-up
Maintenance
Technical data
<b>SI-Safety error types</b>
Encoder types
Validation report
Encoder adaptor
Amendments
Index

## 9.2 SI-Safety alarm list

<b>Alarm code</b>	<b>A 3101</b>
Alarm message	Pulse 1, plausibility fault on input SMF11
Cause	The configured pulse1 voltage is not present at this input.
Remedial action	Check configuration of digital input in accordance with project planning and circuit diagram Check the wiring

<b>Alarm code</b>	<b>A 3102</b>
Alarm message	Pulse 1, plausibility fault on input SMF12
Cause	The configured pulse1 voltage is not present at this input.
Remedial action	Check configuration of digital input in accordance with project planning and circuit diagram Check the wiring

<b>Alarm code</b>	<b>A 3103</b>
Alarm message	Pulse1 plausibility fault at input SMF21
Cause	The configured pulse1 voltage is not present at this input.
Remedial action	Check configuration of digital input in accordance with project planning and circuit diagram Check the wiring

<b>Alarm code</b>	<b>A 3104</b>
Alarm message	Pulse1 plausibility fault at input SMF22
Cause	The configured pulse1 voltage is not present at this input.
Remedial action	Check configuration of digital input in accordance with project planning and circuit diagram Check the wiring

<b>Alarm code</b>	<b>A 3105</b>
Alarm message	Pulse1 plausibility fault at input SMF31
Cause	The configured pulse1 voltage is not present at this input.
Remedial action	Check configuration of digital input in accordance with project planning and circuit diagram Check the wiring

<b>Alarm code</b>	<b>A 3106</b>
Alarm message	Pulse1 plausibility fault at input SMF32
Cause	The configured pulse1 voltage is not present at this input.
Remedial action	Check configuration of digital input in accordance with project planning and circuit diagram Check the wiring

<b>Alarm code</b>	<b>A 3107</b>
Alarm message	Pulse1 plausibility fault at input SMF41
Cause	The configured pulse1 voltage is not present at this input.
Remedial action	Check configuration of digital input in accordance with project planning and circuit diagram Check the wiring

<b>Alarm code</b>	<b>A 3108</b>
Alarm message	Pulse1 plausibility fault at input SMF42
Cause	The configured pulse2 voltage is not present at this input.
Remedial action	Check configuration of digital input in accordance with project planning and circuit diagram Check the wiring

<b>Alarm code</b>	<b>A 3109/3110</b>
Alarm message	Pulse1 plausibility fault at digital input E0.5
Cause	The configured pulse2 voltage is not present at this input.
Remedial action	Check configuration of digital input in accordance with project planning and circuit diagram Check the wiring

<b>Alarm code</b>	<b>A 3117</b>
Alarm message	Pulse 2, plausibility fault on input SMF11
Cause	The configured pulse2 voltage is not present at this input.
Remedial action	Check configuration of digital input in accordance with project planning and circuit diagram Check the wiring

<b>Alarm code</b>	<b>A 3118</b>
Alarm message	Pulse2 plausibility fault at input SMF12
Cause	The configured pulse2 voltage is not present at this input
Remedial action	Check configuration of digital input in accordance with project planning and circuit diagram Check the wiring

<b>Alarm code</b>	<b>A 3119</b>
Alarm message	Pulse2 plausibility fault at input SMF21
Cause	The configured pulse2 voltage is not present at this input
Remedial action	Check configuration of digital input in accordance with project planning and circuit diagram Check the wiring

Safety information
Device type
Technical safety features
Installation
SI-Safety module response times
Start-up
Maintenance
Technical data
SI-Safety error types
Encoder types
Validation report
Encoder adaptor
Amendments
Index

<b>Alarm code</b>	<b>A 3120</b>
Alarm message	Pulse2 plausibility fault at input SMF22
Cause	The configured pulse2 voltage is not present at this input.
Remedial action	Check configuration of digital input in accordance with project planning and circuit diagram Check the wiring

<b>Alarm code</b>	<b>A 3121</b>
Alarm message	Pulse2 plausibility fault at input SMF31
Cause	The configured pulse2 voltage is not present at this input.
Remedial action	Check configuration of digital input in accordance with project planning and circuit diagram Check the wiring

<b>Alarm code</b>	<b>A 3122</b>
Alarm message	Pulse2 plausibility fault at input SMF32
Cause	The configured pulse2 voltage is not present at this input.
Remedial action	Check configuration of digital input in accordance with project planning and circuit diagram Check the wiring

<b>Alarm code</b>	<b>A 3123</b>
Alarm message	Pulse2 plausibility fault at input SMF41
Cause	The configured pulse2 voltage is not present at this input
Remedial action	Check configuration of digital input in accordance with project planning and circuit diagram Check the wiring

<b>Alarm code</b>	<b>A 3124</b>
Alarm message	Pulse2 plausibility fault at input SMF42
Cause	The configured pulse2 voltage is not present at this input
Remedial action	Check configuration of digital input in accordance with project planning and circuit diagram Check the wiring

<b>Alarm code</b>	<b>A 3125/3126</b>
Alarm message	Pulse2 plausibility fault at digital input E0.5
Cause	The configured pulse2 voltage is not present at this input.
Remedial action	Check configuration of digital input in accordance with project planning and circuit diagram Check the wiring

<b>Alarm code</b>	<b>A 3159</b>
Alarm message	Defective 24V signal at input SMF11
Cause	There is no continuous 24V voltage at this input
Remedial action	Check voltage at the digital input. Check the wiring Check for presence of Pulse1 or Pulse2

<b>Alarm code</b>	<b>A 3160</b>
Alarm message	Defective 24V signal at digital input SMF12
Cause	There is no continuous 24V voltage at this input
Remedial action	Check voltage at the digital input Check the wiring Check for presence of Pulse1 or Pulse2

<b>Alarm code</b>	<b>A 3161</b>
Alarm message	Defective 24V signal at digital input SMF21
Cause	There is no continuous 24V voltage at this input
Remedial action	Check voltage at the digital input. Check the wiring Check for presence of Pulse1 or Pulse2

<b>Alarm code</b>	<b>A 3162</b>
Alarm message	Defective 24V signal at digital input SMF22
Cause	There is no continuous 24V voltage at this input
Remedial action	Check voltage at the digital input Check the wiring Check for presence of Pulse1 or Pulse2

<b>Alarm code</b>	<b>A 3163</b>
Alarm message	Defective 24V signal at input SMF31
Cause	There is no continuous 24V voltage at this input
Remedial action	Check voltage at the digital input Check the wiring Check for presence of Pulse1 or Pulse2

<b>Alarm code</b>	<b>A 3164</b>
Alarm message	Defective 24V signal at input SMF32
Cause	There is no continuous 24V voltage at this input
Remedial action	Check voltage at the digital input. Check the wiring Check for presence of Pulse1 or Pulse2

Safety information
Device type
Technical safety features
Installation
SI-Safety module response times
Start-up
Maintenance
Technical data
SI-Safety error types
Encoder types
Validation report
Encoder adaptor
Amendments
Index

<b>Alarm code</b>	<b>A 3165</b>
Alarm message	Defective 24V signal at digital input SMF41
Cause	There is no continuous 24V voltage at this input
Remedial action	Check voltage at the digital input Check the wiring Check for presence of Pulse1 or Pulse2

<b>Alarm code</b>	<b>A 3166</b>
Alarm message	Defective 24V signal at digital input SMF42
Cause	There is no continuous 24V voltage at this input
Remedial action	Check voltage at the digital input Check the wiring Check for presence of Pulse1 or Pulse2

<b>Alarm code</b>	<b>A 3167/3168</b>
Alarm message	Defective 24V signal at digital input E0.5
Cause	There is no continuous 24V voltage at this input
Remedial action	Check voltage at the digital input Check the wiring Check for presence of Pulse1 or Pulse2

<b>Alarm code</b>	<b>A 3191/3192</b>
Alarm message	Short circuit between digital inputs
Cause	Faulty module
Remedial action	Replace module

<b>Alarm code</b>	<b>A 3197/3198</b>
Alarm message	Defective test voltage digital input
Cause	Test voltage is faulty
Remedial action	Check supply voltage for all digital inputs

<b>Alarm code</b>	<b>A 3209 / A 3210</b>
Fault message	Sensor power supply to encoder 1 defective
Cause	Sensor power supply does not correspond to the configured threshold Component defect on the module
Remedial action	Check the configuration Check the sensor power supply Switch the device on/off



<b>Alarm code</b>	<b>A 3213 / A 3214</b>
Fault message	Sensor power supply to encoder 2 defective.
Cause	Sensor power supply does not correspond to the configured threshold Component defect on the module
Remedial action	Check the configuration Check the sensor power supply Switch the device on/off.

<b>Alarm code</b>	<b>A 3229 / A 3230</b>
Fault message	Plausibility test for sensor voltage is defective
Cause	Sensor voltage value
Remedial action	Check sensor voltage value Check wiring for sensor power supply

<b>Alarm code</b>	<b>A 3301 / A 3302</b>
Alarm message	Plausibility fault for speed recording
Cause	The difference between the two speed sensors is greater than the configured speed disengagement threshold
Remedial action	Check theory of route again using the data set in the sensor configuration Check the speed sensor

<b>Alarm code</b>	<b>A 3303 / A 3304</b>
Alarm message	Plausibility fault, position recording
Cause	The difference between the two position signals is greater than the configured increment disengagement threshold
Remedial action	Check theory of route against data configured for the sensor setting Check the position signal Are all signals connected correctly on the sensor connector? Check that the sensor connector circuit is correctly wired

<b>Alarm code</b>	<b>A 3307 / A 3308</b>
Alarm message	Plausibility fault, defective position range
Cause	The prevailing position is outside the configured measuring length
Remedial action	Check theory of route against data configured for the sensor setting Check position signal and, if necessary, correct the offset

Safety information
Device type
Technical safety features
Installation
SI-Safety module response times
Start-up
Maintenance
Technical data
SI-Safety error types
Encoder types
Validation report
Encoder adaptor
Amendments
Index

<b>Alarm code</b>	<b>A 3309 / A 3310</b>
Alarm message	Plausibility fault, defective speed
Cause	The prevailing speed is above the maximum speed setting in the configuration
Remedial action	The drive unit moves outside the permitted and configured speed range Check the configuration Analyse the speed using the SCOPE characteristics curve

<b>Alarm code</b>	<b>A 3311 / A 3312</b>
Alarm message	Configuration fault: acceleration
Cause	Prevailing acceleration is outside the configured acceleration range
Remedial action	The drive unit has exceeded the permitted acceleration range Check the maximum speed configuration Analyse the speed/acceleration using the SCOPE characteristics curve

<b>Alarm code</b>	<b>A 3317 / A 3318</b>
Fault message	Sin-Cosine/TTL Sensor Fault This alarm only can appear, if a single SINCOS or TTL Incremental Encoder is configured
Cause	Plausibility fault between count values of single counter and quadrature counter
Remedial action	Check Encoder Cable Check Encoder Configuration

<b>Alarm code</b>	<b>A 3407 / A 3408</b>
Alarm message	Difference level in RS485 driver1 fault INC_B or SSI_CLK is defective
Cause	No sensor connection Incorrect type of sensor connected up
Remedial action	Check the sensor connection Check the sensor wiring

<b>Alarm code</b>	<b>A 3411 / A 3412</b>
Fault message	Sine-cosine fault, plausibility of encoder 1
Cause	Plausibility monitoring of individual tracks is defective
Remedial action	Check sensor wiring Sine to cosine track must be linear

<b>Alarm Code</b>	<b>A 3505 / A 3506</b>
Fault message	SSI Plausibility
Cause	SSI Plausibility is defective
Remedial action	Replace SSI Encoder

<b>Alarm code</b>	<b>A 4001 / A 4002</b>
Anti clockwise and clockwise motion monitoring of SDI.1 were enabled simultaneously	Anti clockwise and clockwise motion monitoring of SDI.1 were enabled simultaneously
Cause	Multiple activation
Remedial action	When programming the system, ensure that only one 'Enable' at a time is activated

<b>Alarm code</b>	<b>A 4003 / A 4004</b>
Alarm message	Anticlockwise and clockwise motion monitoring of SDI.2 were enabled simultaneously
Cause	Multiple activation
Remedial action	When programming the system, ensure that only one 'Enable' at a time is activated

<b>Alarm code</b>	<b>A 4501 / A 4502</b>
Alarm message	Internal fault – please contact the manufacturer

<b>Alarm code</b>	<b>A 4601 / A 4602</b>
Alarm message	Internal fault – please contact the manufacturer

<b>Alarm code</b>	<b>A 4603 / A 4604</b>
Alarm message	Internal fault – please contact the manufacturer

<b>Alarm code</b>	<b>A 4605 / A 4606</b>
Alarm message	SLP1 Teach in state error
Cause	SET and QUIT input have wrong switching sequence
Remedial action	Check input configuration Check switching sequence

Safety Information
Device type
Technical safety features
Installation
SI-Safety module response times
Start-up
Maintenance
Technical data
SI-Safety error types
Encoder types
Validation report
Encoder adaptor
Amendments
Index

<b>Alarm code</b>	<b>A 4607 / A 4608</b>
Alarm message	SLP2 Teach in state error
Cause	SET and QUIT input have wrong switching sequence
Remedial action	Check input configuration Check switching sequence

<b>Alarm code</b>	<b>A 4609 / A 4610</b>
Alarm message	SLP1 Teach in position error
Cause	Teach in position out of configured range
Remedial action	Check position tolerance input Check switching sequence

<b>Alarm code</b>	<b>A 4611 / A 4612</b>
Alarm message	SLP2 Teach in position error
Cause	Teach in position out of configured range
Remedial action	Check position tolerance input Check switching sequence

<b>Alarm code</b>	<b>A 4613 / A 4614</b>
Alarm message	SLP1 Teach in SOS error
Cause	During teach in motor moved
Remedial action	During teach in motor has to be stopped

<b>Alarm code</b>	<b>A 4615 / A 4616</b>
Alarm message	SLP2x Teach in SOS error
Cause	During teach in motor moved
Remedial action	During teach in motor has to be stopped

<b>Alarm code</b>	<b>A 4901 / A 4902</b>
Alarm message	Anticlockwise and clockwise motion monitoring of SLI.1 were enabled simultaneously
Cause	Multiple activation
Remedial action	When programming the system, ensure that only one 'Enable' at a time is activated

<b>Alarm code</b>	<b>A 4903 / A 4904</b>
Alarm message	Anticlockwise and clockwise motion monitoring of SLI.2 were enabled simultaneously
Cause	Multiple activation
Remedial action	When programming the system, ensure that only one 'Enable' at a time is activated

<b>Alarm code</b>	<b>A 5001 / A 5002</b>
Alarm message	Internal fault – please contact the manufacturer

<b>Alarm code</b>	<b>A 5003 / A 5004</b>
Alarm message	Fault at grouped input SMF1
Cause	Plausibility check for the grouped input has malfunctioned
Remedial action	Check configuration of digital input in accordance with project planning and circuit diagram Check the wiring

<b>Alarm code</b>	<b>A 5005 / A 5006</b>
Alarm message	Fault at grouped input SMF2
Cause	Plausibility check for the grouped input has malfunctioned
Remedial action	Check configuration of digital input in accordance with project planning and circuit diagram Check the wiring

<b>Alarm code</b>	<b>A 5007 / A 5008</b>
Alarm message	Fault at grouped input SMF3
Cause	Plausibility check for the grouped input has malfunctioned
Remedial action	Check configuration of digital input in accordance with project planning and circuit diagram Check the wiring

<b>Alarm code</b>	<b>A 5009 / A 5010</b>
Alarm message	Fault at grouped input SMF4
Cause	Plausibility check for the grouped input has malfunctioned
Remedial action	Check configuration of digital input in accordance with project planning and circuit diagram Check the wiring

<b>Alarm code</b>	<b>A 5011 / A 5012</b>
Alarm message	Internal fault – please contact the manufacturer

<b>Alarm code</b>	<b>A 5013</b>
Alarm message	Plausibility fault at individual input SMF11
Cause	Plausibility check for the individual input has malfunctioned
Remedial action	Check configuration of digital input in accordance with project planning and circuit diagram Check the wiring

Safety information
Device type
Technical safety features
Installation
SI-Safety module response times
Start-up
Maintenance
Technical data
SI-Safety error types
Encoder types
Validation report
Encoder adaptor
Amendments
Index

<b>Alarm code</b>	<b>A 5014</b>
Alarm message	Plausibility fault at individual input SMF12
Cause	Plausibility check for the individual input has malfunctioned
Remedial action	Check configuration of digital input in accordance with project planning and circuit diagram Check the wiring

<b>Alarm code</b>	<b>A 5015</b>
Alarm message	Plausibility fault at individual input SMF21
Cause	Plausibility check for the individual input has malfunctioned
Remedial action	Check configuration of digital input in accordance with project planning and circuit diagram Check the wiring

<b>Alarm code</b>	<b>A 5016</b>
Alarm message	Plausibility fault at individual input SMF22
Cause	Plausibility check for the individual input has malfunctioned
Remedial action	Check configuration of digital input in accordance with project planning and circuit diagram Check the wiring

<b>Alarm code</b>	<b>A 5017</b>
Alarm message	Plausibility fault at individual input SMF31
Cause	Plausibility check for the individual input has malfunctioned
Remedial action	Check configuration of digital input in accordance with project planning and circuit diagram Check the wiring

<b>Alarm code</b>	<b>A 5018</b>
Alarm message	Plausibility fault at individual input SMF32
Cause	Plausibility check for the individual input has malfunctioned
Remedial action	Check configuration of digital input in accordance with project planning and circuit diagram Check the wiring

<b>Alarm code</b>	<b>A 5019</b>
Alarm message	Plausibility fault at individual input SMF41
Cause	Plausibility check for the individual input has malfunctioned
Remedial action	Check configuration of digital input in accordance with project planning and circuit diagram Check the wiring

<b>Alarm code</b>	<b>A 5020</b>
Alarm message	Plausibility fault at individual input SMF42
Cause	Plausibility check for the individual input has malfunctioned
Remedial action	Check configuration of digital input in accordance with project planning and circuit diagram Check the wiring

<b>Alarm code</b>	<b>A 6701 / A 6702</b>
Alarm message	Internal fault – please contact the manufacturer

<b>Alarm code</b>	<b>A 6703 / A 6704</b>
Alarm message	Internal fault – please contact the manufacturer

Safety information
Device type
Technical safety features
Installation
SI-Safety module response times
Start-up
Maintenance
Technical data
<b>SI-Safety error types</b>
Encoder types
Validation report
Encoder adaptor
Amendments
Index

### 9.3 Fault list for SI-Safety

<b>Fault code</b>	<b>F 1001</b>
Fault message	Configuration data were not loaded into the monitoring device properly
Cause	Connection fault when loading the program to the monitoring device
Remedial action	Reload the configuration data, then switch the module on/off.

<b>Fault code</b>	<b>F 1003</b>
Fault message	Configuration data for the module is invalid
Cause	Module configured with incorrect version of software for the programming user interface
Remedial action	Configure the module with the authorized version of the programming user interface, then switch the module on/off

<b>Fault code</b>	<b>F 1007</b>
Fault message	Device was not programmed with the correct programming user interface
Cause	Program or configuration data were loaded onto the device with the wrong programming user interface
Remedial action	Check module version and reconfigure using a valid programming user interface. Then switch the device on/off

<b>Fault code</b>	<b>F 1307</b>
Fault message	Fault when deleting configuration data from flash memory

<b>Fault code</b>	<b>F 1311 / F1312</b>
Fault message	Internal fault – please contact the manufacturer

<b>Fault code</b>	<b>F 1314</b>
Fault message	Internal fault – please contact the manufacturer

<b>Fault code</b>	<b>F 1330</b>
Fault message	Internal fault – please contact the manufacturer

<b>Fault code</b>	<b>F 1401 / F 1402</b>
Fault message	Internal fault – please contact the manufacturer

<b>Fault code</b>	<b>F 1403 / F 1404</b>
Fault message	CRC of configuration data invalid
Cause	Configuration data were transmitted incorrectly
Remedial action	Retransmit the configuration data



<b>Fault code</b>	<b>F 1406</b>
Fault message	Internal fault – please contact the manufacturer
<b>Fault code</b>	<b>F 1407 / F 1408</b>
Fault message	Internal fault – please contact the manufacturer
<b>Fault code</b>	<b>F 1501 / F 1502</b>
Fault message	Internal fault – please contact the manufacturer
<b>Fault code</b>	<b>F 1503 / F 1504</b>
Fault message	Internal fault – please contact the manufacturer
<b>Fault code</b>	<b>F 1505 / F 1506</b>
Fault message	Internal fault – please contact the manufacturer
<b>Fault code</b>	<b>F 1601 / F 1602</b>
Fault message	Range test of device description defective
<b>Fault code</b>	<b>F 1603 / F 1604</b>
Fault message	Range test of Access Data defective
<b>Fault code</b>	<b>F 1605 / F 1606</b>
Fault message	Range test of EMU defective
<b>Fault code</b>	<b>F 1607 / F 1608</b>
Fault message	Range test of PSC defective
<b>Fault code</b>	<b>F 1609 / F 1610</b>
Fault message	Range test of SS1, SS2 defective
<b>Fault code</b>	<b>F 1611 / F 1612</b>
Fault message	Range test of SLPA defective
<b>Fault code</b>	<b>F 1613 / F 1614</b>
Fault message	Range test of SLP defective
<b>Fault code</b>	<b>F 1615 / F 1616</b>
Fault message	Range test of SOS defective
<b>Fault code</b>	<b>F 1617 / F 1618</b>
Fault message	Range test of SLS/SLA defective

Safety information
Device type
Technical safety features
Installation
SI-Safety module response times
Start-up
Maintenance
Technical data
<b>SI-Safety error types</b>
Encoder types
Validation report
Encoder adaptor
Amendments
Index

<b>Fault code</b>	<b>F 1619 / F 1620</b>
Fault message	Range test of SDI defective

<b>Fault code</b>	<b>F 1621 / F 1622</b>
Fault message	Range test of SLI defective

<b>Fault code</b>	<b>F 1623 / F 1624</b>
Fault message	Range test of PLC defective

<b>Fault code</b>	<b>F 1625 / F 1626</b>
Fault message	Range test of cut off channel defective

<b>Fault code</b>	<b>F 1627 / F 1628</b>
Fault message	Range test of outputs defective

<b>Fault code</b>	<b>F 1629 / F 1630</b>
Fault message	Range test of digital inputs defective

<b>Fault code</b>	<b>F 1633 / F 1634</b>
Fault message	Range test of sensor type defective

<b>Fault code</b>	<b>F 1635 / F 1636</b>
Fault message	Range test of sensor processing defective

<b>Fault code</b>	<b>F 1637 / F 1638</b>
Fault message	Range test of sensor position defective

<b>Fault code</b>	<b>F 1639 / F 1640</b>
Fault message	Range test of PDM defective

<b>Fault code</b>	<b>F 1645 / F 1646</b>
Fault message	Range test of sensor configuration defective

<b>Fault code</b>	<b>F 1649 / F 1650</b>
Fault message	Range test of PLC timer defective

<b>Fault code</b>	<b>F 1651 / F 1652</b>
Fault message	Range test of system defective

<b>Fault code</b>	<b>F 1657 / F 1658</b>
Fault message	Range test of diagnosis defective

<b>Fault code</b>	<b>F 2001 / F 2002</b>
Fault message	Internal fault – please contact the manufacturer

<b>Fault code</b>	<b>F 2003 / F 2004</b>
Fault message	Timeout when transmitting the configuration and firmware data

<b>Fault code</b>	<b>F 2005</b>
Fault message	Internal fault – please contact the manufacturer

<b>Fault code</b>	<b>F 2007</b>
Fault message	Internal fault – please contact the manufacturer

<b>Fault code</b>	<b>F 2009</b>
Fault message	Internal fault – please contact the manufacturer

<b>Fault code</b>	<b>F 2011</b>
Fault message	Internal fault – please contact the manufacturer

<b>Fault code</b>	<b>F 2013 / F 2014</b>
Fault message	Internal fault – please contact the manufacturer

<b>Fault code</b>	<b>F 3001 / F 3002</b>
Fault message	Internal fault – please contact the manufacturer

<b>Fault code</b>	<b>F 3201</b>
Fault message	Voltage of 15.0 V is outside the defined range
Cause	Power supply to the module is not correct Component defect on the module
Remedial action	Check the device power supply. Switch the device on/off

<b>Fault code</b>	<b>F 3202</b>
Fault message	Internal fault - please contact the manufacturer

<b>Fault code</b>	<b>F 3203 / F3204</b>
Fault message	24 V power supply to module is defective
Cause	Power supply to the module is not correct Component defect on the module
Remedial action	Check the device power supply. Switch the device on/off

Safety information
Device type
Technical safety features
Installation
SI-Safety module response times
Start-up
Maintenance
Technical data
<b>SI-Safety error types</b>
Encoder types
Validation report
Encoder adaptor
Amendments
Index

<b>Fault code</b>	<b>F 3205 / F3206</b>
Fault message	Differential Voltage Encoder 1
Cause	Power supply to the module is not correct Component defect on the module
Remedial action	Check the device power supply Switch the device on/off

<b>Fault Code</b>	<b>F 3207 / F3208</b>
Fault Message	Differential Voltage Encoder 2
Cause	Power supply to the module is not correct Component defect on the module
Remedial action	Check the device power supply Switch the device on/off

<b>Fault code</b>	<b>F 3217 / F 3218</b>
Fault message	Internal 5 V power supply is defective
Cause	Power supply to the module is not correct Component defect on the module
Remedial action	Check the device power supply Switch the device on/of

<b>Fault code</b>	<b>F 3219</b>
Fault message	Internal fault - please contact the manufacturer
Cause	Power supply to the module is not correct Component defect on the module
Remedial action	Check the device power supply Switch the device on/of

<b>Fault code</b>	<b>F 3237 / F3238</b>
Fault message	Core voltage out of range (Core power domain)
Cause	Core voltage of the micro controller out of range Micro controller cannot work deterministically
Remedial action	Replace module

<b>Fault code</b>	<b>F 3239 / F3240</b>
Fault message	Core voltage out of range (Second power domain)
Cause	Core voltage of the micro controller out of range Micro controller cannot work deterministically
Remedial action	Replace module

<b>Fault code</b>	<b>F 3306</b>
Fault message	Plausibility fault, position changeover
Cause	During position changeover, SOS, SLI or SDI is continuously enabled
Remedial action	Check SOS activation Check SLI activation SDI activation (only when monitoring by position)

<b>Fault code</b>	<b>F 3316</b>
Fault message	Fault in sensor alignment
Cause	Defective position triggering by System A
Remedial action	Check the sensor configuration Switch the device on/off

<b>Fault code</b>	<b>F 3604</b>
Fault message	Defective testing of output STO.1 (static test)
Cause	Output switch status defective
Remedial action	Switch the device on/off

<b>Fault code</b>	<b>F 3605</b>
Fault message	Defective testing of MainSwitch (dynamic test)
Cause	Output switch status defective
Remedial action	Switch the device on/off

<b>Fault code</b>	<b>F 3609</b>
Fault message	Defective switching of output SBC1 (dynamic test)
Cause	Output switch status defective
Remedial action	Switch the device on/off

<b>Fault code</b>	<b>F 3610</b>
Fault message	Defective testing of MainSwitch (static test)
Cause	Output switch status defective
Remedial action	Switch the device on/off

<b>Fault code</b>	<b>F 3611</b>
Fault message	Defective switching of output STO (dynamic test)
Cause	Output switch status defective
Remedial action	Switch the device on/off

Safety information
Device type
Technical safety features
Installation
SI-Safety module response times
Start-up
Maintenance
Technical data
SI-Safety error types
Encoder types
Validation report
Encoder adaptor
Amendments
Index

<b>Fault code</b>	<b>F 3612</b>
Fault message	Defective switching of output SBC2 (dynamic test)
Cause	Output switch status defective
Remedial action	Switch the device on/off

<b>Fault code</b>	<b>F 3614</b>
Fault message	Defective testing of upper limit of power supply (dynamic test)
Cause	Power supply defective
Remedial action	Check the power supply

<b>Fault code</b>	<b>F 3616</b>
Fault message	Defective testing of lower limit of power supply (dynamic test)
Cause	Power supply defective
Remedial action	Check the power supply

<b>Fault code</b>	<b>F 3617</b>
Fault message	Defective testing of STO output (static test)
Cause	Output switch status defective
Remedial action	Switch the device on/off

<b>Fault code</b>	<b>F 3618</b>
Fault message	Defective switching of output SBC1 (static test)
Cause	Output switch status defective
Remedial action	Switch the device on/off

<b>Fault code</b>	<b>F 3619</b>
Fault message	Internal fault – please contact the manufacturer

<b>Fault code</b>	<b>F 3620</b>
Fault message	Defective switching of output SBC2 (static test)
Cause	Output switch status defective
Remedial action	Switch the device on/off

<b>Fault code</b>	<b>F 3621</b>
Fault message	Internal fault – please contact the manufacturer

<b>Fault code</b>	<b>F 3622</b>
Fault message	Internal fault – please contact the manufacturer

<b>Fault code</b>	<b>F 3701 / F3702</b>
Fault message	Internal fault – please contact the manufacturer
<b>Fault code</b>	<b>F 6801 / F 6802</b>
Fault message	Internal fault – please contact the manufacturer
<b>Fault code</b>	<b>F 6803 / F 6804</b>
Fault message	Internal fault – please contact the manufacturer
<b>Fault code</b>	<b>F 6805 / F 6806</b>
Fault message	Internal fault – please contact the manufacturer
<b>Fault code</b>	<b>F 6807 / F 6808</b>
Fault message	Internal fault – please contact the manufacturer
<b>Fault code</b>	<b>F 6809 / F 6810</b>
Fault message	Internal fault – please contact the manufacturer
<b>Fault code</b>	<b>F 6811 / F 6812</b>
Fault message	Internal fault – please contact the manufacturer
<b>Fault code</b>	<b>F 6813 / F 6814</b>
Fault message	Internal fault – please contact the manufacturer
<b>Fault code</b>	<b>F 8205 / F 8206</b>
Fault message	Internal fault – please contact the manufacturer
<b>Fault code</b>	<b>F 8207 / F 8208</b>
Fault message	Internal fault – please contact the manufacturer
<b>Fault code</b>	<b>F 8213 / F 8214</b>
Fault message	Internal fault – please contact the manufacturer

Safety information
Device type
Technical safety features
Installation
SI-Safety module response times
Start-up
Maintenance
Technical data
<b>SI-Safety error types</b>
Encoder types
Validation report
Encoder adaptor
Amendments
Index

<b>Fault code</b>	<b>F 8220</b>
Fault message	Internal fault – please contact the manufacturer

<b>Fault code</b>	<b>F 8221 / F 8222</b>
Fault message	Internal fault – please contact the manufacturer

<b>Fault code</b>	<b>F 8223 / F 8224</b>
Fault message	Internal fault – please contact the manufacturer

<b>Fault code</b>	<b>F 8225</b>
Fault message	Internal fault – please contact the manufacturer

<b>Fault code</b>	<b>F 8227</b>
Fault message	Internal fault – please contact the manufacturer

<b>Fault code</b>	<b>F 8228</b>
Fault message	Internal fault – please contact the manufacturer

<b>Fault code</b>	<b>F 9001 / F 9002</b>
Fault message	Internal fault – please contact the manufacturer

<b>Fault code</b>	<b>F 9007 / F 9008</b>
Fault message	Internal fault – please contact the manufacturer

<b>Fault code</b>	<b>F 9009 / F 9010</b>
Fault message	Internal fault – please contact the manufacturer

<b>Fault code</b>	<b>F 9011 / F 9012</b>
Fault message	Internal fault – please contact the manufacturer

<b>Fault code</b>	<b>F 9013 / F 9014</b>
Fault message	Internal fault – please contact the manufacturer

<b>Fault code</b>	<b>F 9015 / F 9016</b>
Fault message	Internal fault – please contact the manufacturer

<b>Fault code</b>	<b>F 9017 / F 9018</b>
Fault message	Internal fault – please contact the manufacturer



# 10 Encoder types

Table 10-1 Encoder types

Type	Encoder A			Encoder B			Permitted Function Blocks	Comment Fault exclusion / comment	SIL
	Type	Count multiple	Enable direction	Type	Count multiplier	Enable direction			
1	Incremental	4	Yes	Not connected	4	No	SS1, SS2, SLS, SOS, SDI, SLI, SCA*	Fault exclusion, mech. shaft failure, positive sensor shaft connection essential	2
2	SINCOS	4	Yes	Not connected	4	No	SS1, SS2, SLS, SOS, SDI, SLI, SCA*	Fault exclusion, mech. shaft failure, positive sensor shaft connection essential	2
3	Incremental	4	Yes	Incremental	4	Yes	SS1, SS2, SLS, SOS, SDI, SLI, SCA*		3
4	SINCOS	4	Yes	Incremental	4	Yes	SS1, SS2, SLS, SOS, SDI, SLI, SCA*		3
5	SINCOS	4	Yes	SINCOS	4	Yes	SS1, SS2, SLS, SOS, SDI, SLI, SCA*		3
6	Incremental	4	Yes	SSI (Synchronous Serial Interface)	1	Yes	SS1, SS2, SLS, SOS, SDI, SLI, SLP, SCA		2/3**
7	SINCOS	4	Yes	SSI (Synchronous Serial Interface)	1	Yes	SS1, SS2, SLS, SOS, SDI, SLI, SLP, SCA		2/3**
8	SSI (Synchronous Serial Interface)	1	Yes	SSI (Synchronous Serial Interface)	1	Yes	SS1, SS2, SLS, SOS, SDI, SLI, SLP, SCA*		3
9	Incremental	4	Yes	Proxi	N/A	N/A	SS1, SS2, SLS, SOS, SDI, SLI, SLP, SCA*		3
10	SINCOS	4	Yes	Proxi	N/A	N/A	SS1, SS2, SLS, SOS, SDI, SLI, SLP, SCA*		3

\* Speed and/or acceleration monitoring only.

\*\* SIL2 for absolute position processing functions, SIL3 for speed and incremental position monitoring.

Safety Information
Device type
Technical safety features
Installation
SI-Safety module response times
Start-up
Maintenance
Technical data
SI-Safety error types
Encoder types
Validation report
Encoder adaptor
Amendments
Index

---

# 11 Validation report

---

## 11.1 Overview

A validation report is available to assist users in the validation of their safety system. It is initiated from *CTSafePro*. It provides a report of the configuration of the SI-Safety Module. The report is generated as an Excel spreadsheet.

## 11.2 Report generation

The SI-Safety Module must be connected to a computer running *CTSafePro* using a CT USB cable. To generate the report, select the connection window, click on "Connect", "Validation" and "Generate Report".

## 11.3 Report format

The report provides the following information.

- Three pages of header data
- Sensor configuration
- PLC program listing
- Input/output configuration
- Function block configuration

### 11.3.1 Header data

The header data requires some manual data entry. This can be entered using Excel or hand written on the printed report.

The first page allows for entry of the project name, customer and date. There is also provision for acceptance sign off details. The second page allows for entry of general details about the system.

The last page of the header provides check-boxes for individual verification of the technical safety test.

### 11.3.2 Sensor configuration

The configuration of the working section and each encoder is provided. There are individual verification check-boxes for each configurable parameter to confirm that it meets the requirements of the safety design.

#### NOTE

If a single encoder is used, the report will record this as two encoders with identical configuration. This is due to the fact that a single encoder signal must be connected to both encoder inputs in order to minimize the effect of electrical noise.

### 11.3.3 PLC program listing

The PLC program is printed in Instruction List format.

### 11.3.4 Input / Output configuration

The configuration of each digital input and output is provided. There are individual verification check-boxes for each configurable parameter to confirm that it meets the requirements of the safety design.

#### NOTE

If a single encoder is used, the report will record this as two encoders with identical configuration. This is due to the fact that a single encoder signal must be connected to both encoder inputs in order to minimize the effect of electrical noise.

### 11.3.5 Function block configuration

The configuration of each safety function block is provided. There are individual verification check-boxes for each configurable parameter to confirm that it meets the requirements of the safety design.

# 12 Encoder adaptor



Power down the drive before connecting/disconnecting any cables to the encoder adaptor. Failure to do so may result in a serious accident.

## 12.1 Overview

An encoder adaptor is available to assist in the connection of the encoders to the SI-Safety Module.

Two versions of the adaptor are available

- Dual Encoder Adaptor - 82000000015900
- Single Encoder Adaptor - 82000000016000

## 12.2 Single encoder adapter

The SI-Safety Single Encoder Adapter is intended for use with the SI-Safety Module when the module is used with one encoder.

**Figure 12-1 Single encoder adapter connections**

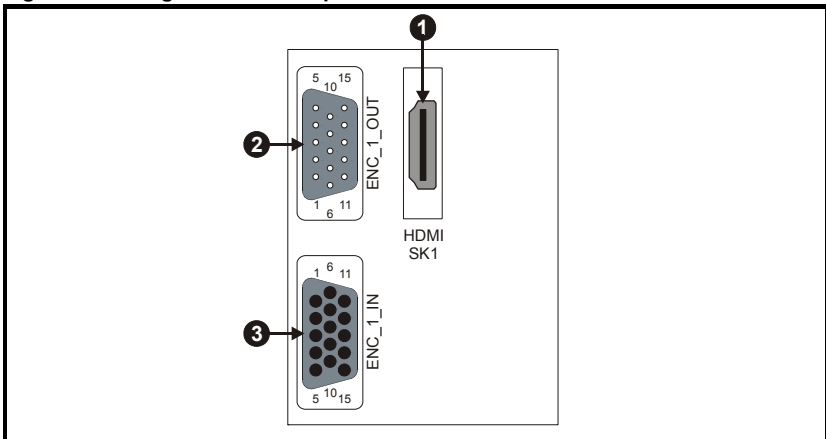

**Table 12-1 Single encoder cable requirements**

Ref	Adapter connection	Cable destination	Cable / Connector
1	HDMI SK1	SI-Safety Module	Standard commercially available HDMI cable with gold connectors, maximum length 1 metre
2	ENC_1_OUT	Drive/Option module	Shielded twisted pair cable with 15 way high density D type male-female connectors
3	ENC_1_IN	Encoder 1	Shielded twisted pair cable with 15 way high density D type male connector and encoder connector

## 12.3 Dual encoder adapter

The SI-Safety Dual Encoder Adapter is intended for use with the SI-Safety Module when the module is used with two encoders.

**Figure 12-2 Dual encoder adapter connections**

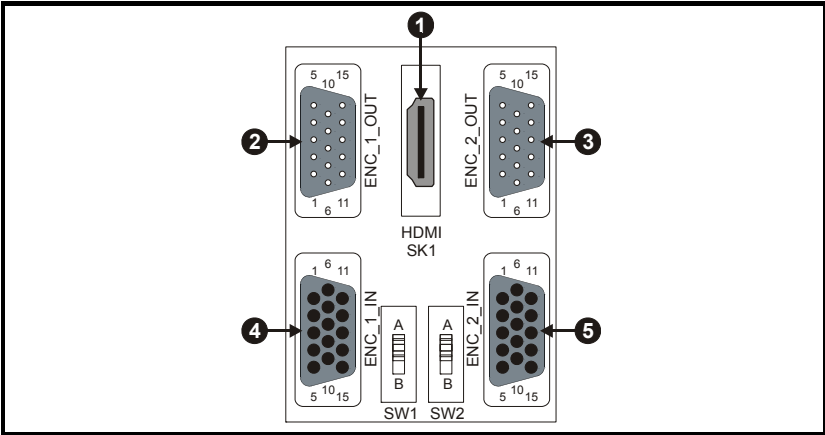

**Table 12-2 Switch settings**

Encoder 1	Encoder 2	SW1	SW2
SC	Ab	A	A
Ab	Ab	A	A
SC	SC	A	A
Ab	SC.SSI	A	B
SC	SC.SSI	A	B
SC.SSI	SC.SSI	B	B
Ab	SSI	A	A
SC	SSI	A	A
SSI	SSI	A	A

**NOTE**

Table overleaf shows links made with the switches.

Switch position	Encoder connection	HDMI connection
Enc1(SW1) Switch position A	1	1
	2	3
	3	4
	4	6
Enc1(SW1) Switch position B	5	1
	6	3
	11	4
	12	6
Enc2(SW2) Switch position A	1	7
	2	9
	3	10
	4	12
Enc2(SW2) Switch position B	5	7
	6	9
	11	10
	12	12

**Table 12-3 Dual encoder cable requirements**

Ref	Adapter connection	Cable Destination	Cable/Connector
1	HDMI SK1	SI-Safety Module	Standard commercially available HDMI cable with gold connectors, maximum length 1 metre
2	ENC_1_OUT	Drive/Option module	Shielded twisted pair cable with 15 way high density D type male-female connectors
3*	ENC_2_OUT	Drive/Option module	Shielded twisted pair cable with 15 way high density D type male-female connectors
4	ENC_1_IN	Encoder 1	Shielded twisted pair cable with 15 way high density D type male connector and encoder connector
5	ENC_2_IN	Encoder 2	Shielded twisted pair cable with 15 way high density D type male connector and encoder connector

\* Not required for SSI when configured for master clock. Option module can be SI-Universal Encoder.

## 12.4 Connector details

Table 12-4 15 way connector details

Term	Encoder									
	Ab	AB.Servo	SC	SC.Hiper	SC.Endat	SC.SSI	SSI			
1	A	A	Cos	Cos	Cos	Cos	Data			
2	A\	A\	Cosref	Cosref	Cosref	Cosref	Data\			
3	B	B	Sin	Sin	Sin	Sin	Clock			
4	B\	B\	Sinref	Sinref	Sinref	Sinref	Clock\			
5	Z*	Z*		Data*	Data*	Data				
6	Z\*	Z\*		Data\*	Data\*	Data\				
7		U*								
8		U\*								
9		V*								
10		V\*								
11		W*							Clock*	Clock
12		W\*							Clock\*	Clock\
13		+V								
14	0V common									
15	th*									

\* Hardwired connection between encoder input and output only. Signals not used for SI-Safety Module.

For details of the HDMI connections refer to Table 4-3 *Encoder interface HDMI* on page 40.

## 12.5 Electromagnetic Compatibility (EMC)

In order to guarantee maximum noise immunity, the encoder cabling must follow the EMC guidelines in the relevant *Drive User Guide* and the encoder and HDMI cable shields must be clamped to the drive grounding bracket.

# 13 Amendments

## 13.1 Amendments Index

The English version of the Installation and Operating manual, part number 0478-0139-01, is the original and master version.

Index	Page	Date	Author	Modification/ amendment
1	All	August 2014	Steve Wright	First Issue
2	6 & 7	November 2014	Steve Wright	Declaration Of Conformity (2006) added
3	IFC	January 2015	Steve Wright	Original Instructions added to page
4	54	January 2015	Steve Wright	Clarification of Pr <b>20.013</b>
5	40	August 2016	Tim Law	Table 4-3 updated
6	83	August 2016	Tim Law	Table 12-1 updated
7	84	August 2016	Tim Law	Table 12-2 updated
8	84	August 2016	Tim Law	New 'Note' inserted
9	85	August 2016	Tim Law	New table added after Table 12-2
10	85	August 2016	Tim Law	Table 12-3 updated
11	86	August 2016	Tim Law	Table 12-4 updated

Safety Information
Device type
Technical safety features
Installation
SI-Safety module response times
Start-up
Maintenance
Technical data
SI-Safety error types
Encoder types
Validation report
Encoder adaptor
<b>Amendments</b>
Index

---

# Index

---

<b>A</b>	
Absolute encoder .....	43
Adjusting parameters .....	12
Auxiliary output circuit .....	34
<b>C</b>	
Combining different types of encoder .....	41
Compliance with regulations .....	12
Configuration .....	16, 49
Configuring the SSI format .....	43
Connecting position and speed sensors .....	39
Connection of digital inputs SMF11 to SMF42 and E0.5 .....	36
CTSafePro .....	16, 36, 43, 49, 55
<b>D</b>	
Definition of terms .....	7
Diagnostic parameters .....	51
Diagnostics Absolute encoder .....	43
Digital input signals .....	20
Dual scanning and signal processing in two channels .....	37
<b>E</b>	
Electrical safety .....	11
Encoder interface .....	38
Encoder interface HDMI .....	40
Encoder types .....	81, 82, 83
Environmental conditions .....	58
<b>F</b>	
Failure curve velocity measuring .....	29
Fault list for SI-Safety .....	72
Function test .....	50
<b>G</b>	
General diagnostic measures for encoder interface .....	26
General installation notes .....	35
General safety instructions .....	10
Grouped inputs .....	19
<b>I</b>	
Incremental sensor .....	43
Input / output status indication .....	57
Input output interface .....	38
<b>K</b>	
Key technical safety indicators .....	58
<b>L</b>	
LED display .....	49
<b>M</b>	
Maintenance intervals .....	51



Model plate .....	17
Modification .....	51
Module replacement .....	51
Motor .....	12
<b>N</b>	
Non grouped inputs .....	20
<b>P</b>	
Proxi switch .....	44
<b>R</b>	
Response time standard operating mode .....	46
<b>S</b>	
Safety of personnel .....	7
Scope of supply .....	17
Sensors for speed and/or position recording .....	25
SIN/COS encoder .....	41
Sine-cosine sensor standard mode .....	44
Single channel sensor .....	21
Single channel sensor with pulse crossfault checking .....	23
Single pin switching P output with external test .....	32
Single pin switching P output without frequency inverter .....	32
SI-Safety alarm list .....	60
SI-Safety module .....	15
SI-Safety module response times .....	45
Software diagnostics .....	57
Specific diagnostic measures relating to the type of encoder used .....	28
Start-up / commissioning .....	49
System design .....	11
<b>T</b>	
Technical safety features .....	18
Technical safety test .....	50
Terms and abbreviations .....	9
Two channel sensor .....	22
Two channel sensor with crossfault checking .....	23
Two channel sensor without crossfault checking complementary .....	22
Two channel sensor, complementary .....	24
Two channel switching output with external monitoring .....	33
<b>V</b>	
Validation .....	50

Safety Information
Device type
Technical safety features
Installation
SI-Safety module response times
Start-up
Maintenance
Technical data
SI-Safety error types
Encoder types
Validation report
Encoder adaptor
Amendments
<b>Index</b>



**0478-0139-04**