



User Guide

SI-CANopen

Part Number: 0478-0101-01

Issue: 1



www.controltechniques.com

Original Instructions

For the purposes of compliance with the EU Machinery Directive 2006/42/EC

General information

The manufacturer accepts no liability for any consequences resulting from inappropriate, negligent or incorrect installation or adjustment of the optional operating parameters of the equipment or from mismatching the variable speed drive with the motor.

The contents of this guide are believed to be correct at the time of printing. In the interests of a commitment to a policy of continuous development and improvement, the manufacturer reserves the right to change the specification of the product or its performance, or the contents of the guide, without notice.

All rights reserved. No parts of this guide may be reproduced or transmitted in any form or by any means, electrical or mechanical including photocopying, recording or by an information storage or retrieval system, without permission in writing from the publisher.

Drive firmware version

This product is supplied with the latest firmware version. If this drive is to be connected to an existing system or machine, all drive firmware versions should be verified to confirm the same functionality as drives of the same model already present. This may also apply to drives returned from a Control Techniques Service Centre or Repair Centre. If there is any doubt please contact the supplier of the product.

The firmware version of the drive can be checked by looking at Pr **11.029**.

Environmental statement

Control Techniques is committed to minimising the environmental impacts of its manufacturing operations and of its products throughout their life cycle. To this end, we operate an Environmental Management System (EMS) which is certified to the International Standard ISO 14001. Further information on the EMS, our Environmental Policy and other relevant information is available on request, or can be found at www.greendrives.com.

The electronic variable-speed drives manufactured by Control Techniques have the potential to save energy and (through increased machine/process efficiency) reduce raw material consumption and scrap throughout their long working lifetime. In typical applications, these positive environmental effects far outweigh the negative impacts of product manufacture and end-of-life disposal.

Nevertheless, when the products eventually reach the end of their useful life, they must not be discarded but should instead be recycled by a specialist recycler of electronic equipment. Recyclers will find the products easy to dismantle into their major component parts for efficient recycling. Many parts snap together and can be separated without the use of tools, while other parts are secured with conventional fasteners. Virtually all parts of the product are suitable for recycling.

Product packaging is of good quality and can be re-used. Large products are packed in wooden crates, while smaller products come in strong cardboard cartons which themselves have a high recycled fibre content. If not re-used, these containers can be recycled. Polythene, used on the protective film and bags for wrapping product, can be recycled in the same way. Control Techniques' packaging strategy prefers easily-recyclable materials of low environmental impact, and regular reviews identify opportunities for improvement.

When preparing to recycle or dispose of any product or packaging, please observe local legislation and best practice.

REACH legislation

EC Regulation 1907/2006 on the Registration, Evaluation, Authorisation and restriction of Chemicals (REACH) requires the supplier of an article to inform the recipient if it contains more than a specified proportion of any substance which is considered by the European Chemicals Agency (ECHA) to be a Substance of Very High Concern (SVHC) and is therefore listed by them as a candidate for compulsory authorisation.

For current information on how this requirement applies in relation to specific Control Techniques products, please approach your usual contact in the first instance. Control Techniques position statement can be viewed at: <http://www.controltechniques.com/REACH>

Copyright © July 2013 Control Techniques Ltd

Issue Number: 1

Drive Firmware: 01.02.00.00 onwards

For patent and intellectual property related information please go to: www.ctpatents.info

Contents

1	Safety information	4	7	Cyclic Data	53
1.1	Warnings, Cautions and Notes	4	7.1	What is a “Process Data Object”?	53
1.2	Electrical safety - general warning	4	7.2	PDO data mapping errors	53
1.3	System design and safety of personnel	4	7.3	Unused PDO data channels	53
1.4	Environmental limits	4	7.4	Changing PDO mapping parameters (via controller/PLC)	53
1.6	Compliance with regulations	4	7.5	Blank mapping parameters (via controller/PLC)	53
1.7	Adjusting parameters	4	8	Non Cyclic Data	55
2	Introduction	5	8.1	Service data object (SDO) parameter access	55
2.1	What Is CANopen?	5	9	Control / status word	57
2.2	What is SI-CANopen?	7	9.1	What are control and status words?	57
2.3	General specification	7	9.2	Control word	57
2.4	Option module identification	7	9.3	Status word	59
2.5	Conventions used in this guide	8	10	EDS Files	61
2.6	Conventions used for SI-CANopen	8	10.1	What are EDS files?	61
3	Mechanical installation	9	10.2	Generic EDS files	61
3.1	General installation	9	11	CANopen reference	62
4	Electrical	10	11.1	CANopen object dictionary	62
4.1	SI-CANopen terminal descriptions	10	11.2	Basic data types	63
4.2	CANopen cable	10	11.3	Device type	63
4.3	CANopen network termination	11	11.4	Flexible PDO numbering (0x2800 and 0x2801)	68
4.4	SI-CANopen cable shield connections	11	11.5	Mapping parameter values	68
4.5	SI-CANopen ground point	11	11.6	RxPDO communication parameters	69
4.6	Maximum network length	11	11.7	RxPDO mapping parameters	72
4.7	Spurs	11	11.8	TxPDO communication parameters	73
4.8	Minimum node to node cable length	11	11.9	TxPDO mapping parameters	76
5	Getting Started	12	11.10	RxPDO, SYNC and missed heartbeat event handling	78
5.1	Parameter save and restore	12	11.11	RxPDO event triggers	84
5.2	Module reset	12	11.12	TxPDO event triggers	86
5.3	Restoring module parameter default values	12	11.13	Network management objects (NMT)	88
5.4	Single Line Parameters	12	11.14	NMT commands	89
5.5	PDO number configuration	19	11.15	Layer setting services (LSS)	89
5.6	PDO structure (PDOs A, B, C & D)	19	11.16	Emergency object	94
5.7	Types of set-up	19	11.17	Emergency object state	95
5.8	Configuration overview	20	11.18	Device profiles	96
5.9	Setup flowcharts	21	12	Diagnostics	108
6	Parameters	31	12.1	Overview	108
6.1	Menus	31	13	Glossary of terms	110
6.2	Menu 0 - Module Set-up	31			
6.3	Menu 1 - SI-CANopen Setup	33			
6.4	Menu 2 - PDOA Setup	39			
6.5	Menu 3 - PDOB Setup	43			
6.6	Menu 4 – PDOC Setup	46			
6.7	Menu 5 – PDOD Setup	49			
6.8	Menu 6 – RPDO Fault	52			

1 Safety information

1.1 Warnings, Cautions and Notes



A **Warning** contains information, which is essential for avoiding a safety hazard.



A **Caution** contains information, which is necessary for avoiding a risk of damage to the product or other equipment.

NOTE A **Note** contains information which helps to ensure correct operation of the product.

1.2 Electrical safety - general warning

The voltages used in the drive can cause severe electrical shock and/or burns, and could be lethal. Extreme care is necessary at all times when working with or adjacent to the drive.

Specific warnings are given at the relevant places in this User Guide.

1.3 System design and safety of personnel

The drive is intended as a component for professional incorporation into complete equipment or a system. If installed incorrectly, the drive may present a safety hazard. The drive uses high voltages and currents, carries a high level of stored electrical energy, and is used to control equipment which can cause injury. Close attention is required to the electrical installation and the system design to avoid hazards either in normal operation or in the event of equipment malfunction. System design, installation, Commissioning/start-up and maintenance must be carried out by personnel who have the necessary training and experience. They must read this safety information and this User Guide carefully.

The STOP and SAFE TORQUE Off functions of the drive do not isolate dangerous voltages from the output of the drive or from any external option unit. The supply must be disconnected by an approved electrical isolation device before gaining access to the electrical connections.

With the sole exception of the SAFE TORQUE Off function, none of the drive functions must be used to ensure safety of personnel, i.e. they must not be used for safety-related functions.

Careful consideration must be given to the functions of the drive which might result in a hazard, either through their intended behavior or through incorrect operation due to a fault. In any application where a malfunction of the drive or its control system could lead to or allow damage, loss or injury, a risk analysis must be carried out, and where necessary, further measures taken to reduce the risk - for example, an over-speed protection device in case of failure of the speed control, or a fail-safe mechanical brake in case of loss of motor braking.

The system designer is responsible for ensuring that the complete system is safe and designed correctly according to the relevant safety standards.

1.4 Environmental limits

Instructions in the *Unidrive M User Guide* regarding transport, storage, installation and use of the drive must be complied with, including the specified environmental limits. Drives must not be subjected to excessive physical force.

1.5 Access

Drive access must be restricted to authorized personnel only. Safety regulations which apply at the place of use must be complied with.

1.6 Compliance with regulations

The installer is responsible for complying with all relevant regulations, such as national wiring regulations, accident prevention regulations and electromagnetic compatibility (EMC) regulations. Particular attention must be given to the cross-sectional areas of conductors, the selection of fuses or other protection, and protective earth (ground) connections.

The *Unidrive M User Guide* contains instructions for achieving compliance with specific EMC standards.

Within the European Union, all machinery in which this product is used must comply with the following directives:

- 2006/42/EC: Safety of machinery.
- 2004/108/EC: Electromagnetic Compatibility.

1.7 Adjusting parameters

Some parameters have a profound effect on the operation of the drive. They must not be altered without careful consideration of the impact on the controlled system. Measures must be taken to prevent unwanted changes due to error or tampering.

1.7.1 Stored charge

The drive contains capacitors that remain charged to a potentially lethal voltage after the AC supply has been disconnected. If the drive has been energized, the AC supply must be isolated at least ten minutes before work may continue.

2 Introduction

2.1 What Is CANopen?

CANopen is a networking system that falls into the generic category of Fieldbus. Fieldbuses are generally defined as industrial networking systems that are intended to replace traditional wiring systems. Figure 2-1 shows the traditional cabling requirements to transfer signals between a controller and two nodes.

Figure 2-1 Traditional cable layout

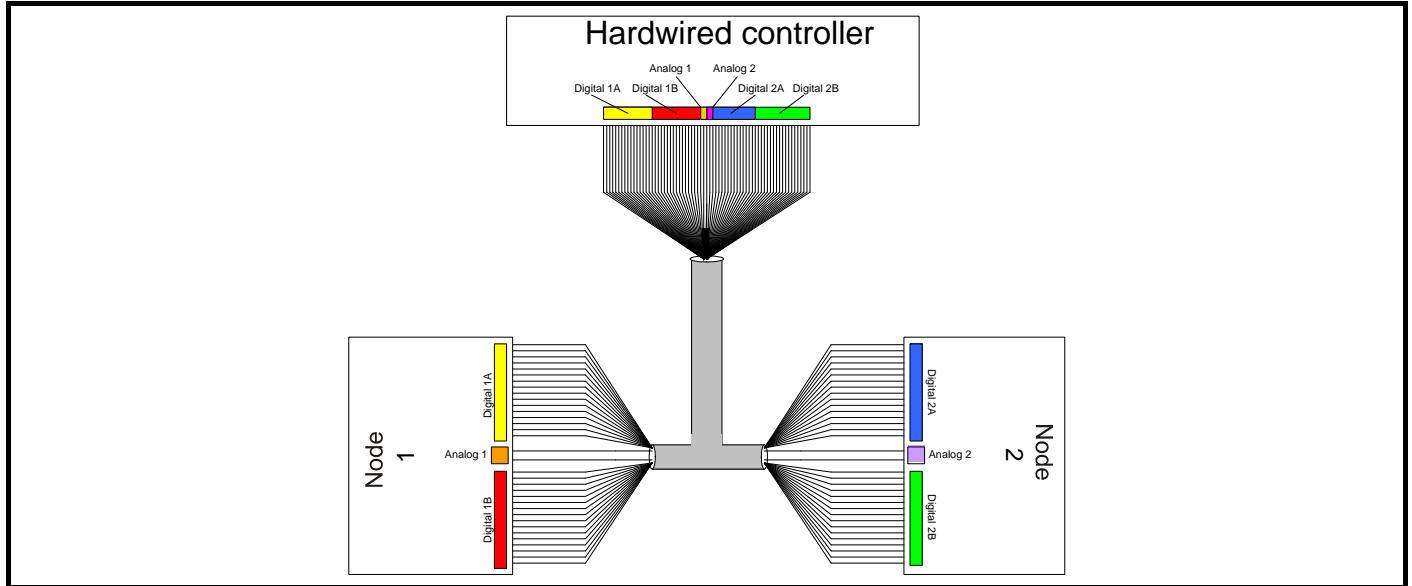

Table 2-1 details how the wiring is used to communicate data between the controller and the nodes. Each signal which is communicated requires one signal wire giving a total of 66 signal wires plus a 0 V return.

Table 2-1 Traditional wiring details

Number of signals	Type	Source / Destination	Description
16	digital Inputs	node 1 to controller	status signals
16	digital outputs	controller to node 1	control signals
1	analog output	controller to node 1	control signal
16	digital inputs	node 2 to controller	status signals
16	digital outputs	controller to node 2	control signals
1	analog output	controller to node 2	control signal

A fieldbus topology such as CANopen allows the same configuration to be realized using only two signal wires plus a shield. This method of communication saves significantly on the amount of cabling required and can improve overall system reliability as the number of interconnections is greatly reduced.

Figure 2-2 shows a typical CANopen network system transferring the same signals as given in the traditionally wired example. The signals are now transmitted by converting them into a serial data stream which is received by the master as if they were connected using traditional wiring. The data stream on CANopen allows up to 32 (16 input and 16 output) independent values to be sent or received by the master, there is also a method available to allow a single channel random access (non-cyclic data access) to drive parameters.

Figure 2-2 SI-CANopen cable layout

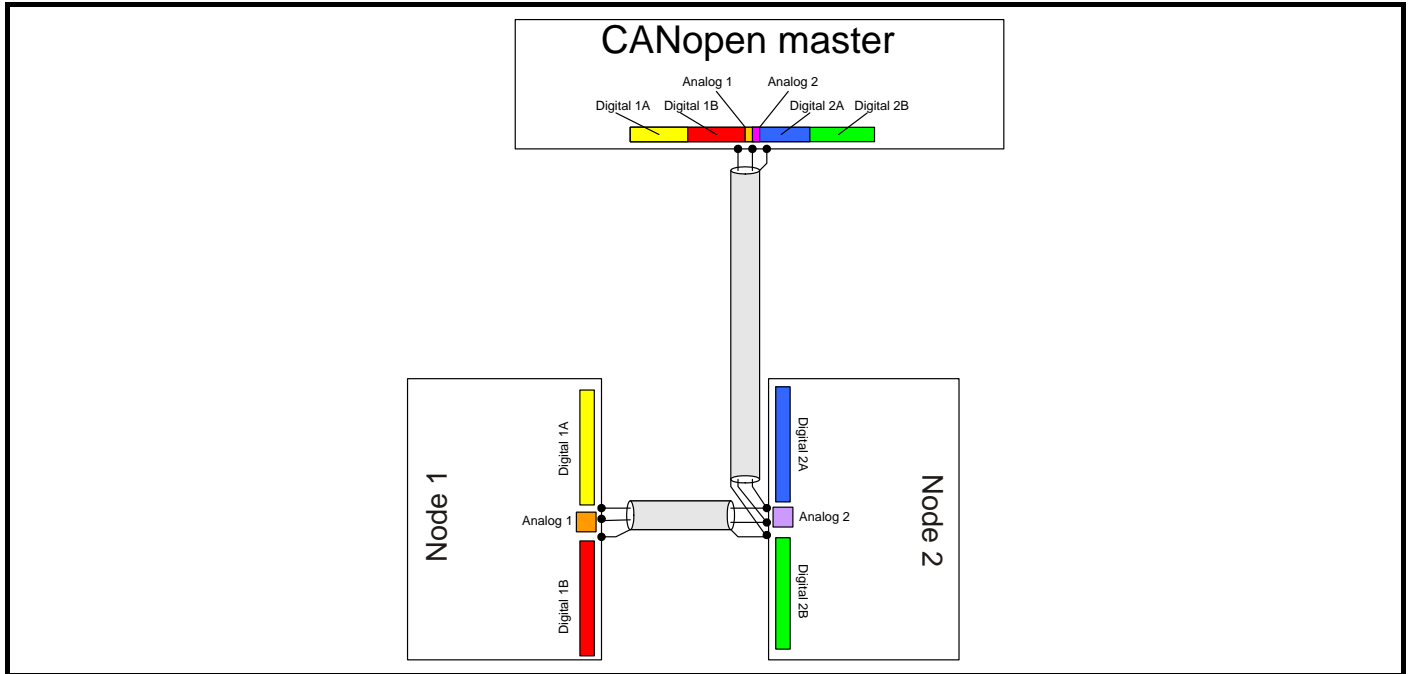

Figure 2-2 details the number of data words used to communicate the signals using the CANopen network. It can be seen that the resulting reduction in cabling is significant.

Table 2-2 Data mappings for SI-CANopen

Number of network words	Type	Source / Destination	Description
1	digital inputs	node 1 to controller	status signals
1	digital outputs	controller to node 1	control signals
1	analog output	controller to node 1	control signal
1	digital inputs	node 2 to controller	status signals
1	digital outputs	controller to node 2	control signals
1	analog output	controller to node 2	control signal

SI-CANopen transfers data using two distinct modes. The first of these modes is cyclic where signals are sent in predefined blocks at regular intervals. This is the equivalent of the hard-wired example above in Figure 2-1.

The second method of transfer is called non-cyclic data (SI-CANopen may use SDOs for non-cyclic data) and is used for sending values that only need to be changed occasionally or where the source or destination of the signal changes. This is the equivalent of a temporary 'patch lead' that is removed after use.

2.2 What is SI-CANopen?

SI-CANopen is a fieldbus option module that can be installed to the expansion slot(s) in any of the following drives to provide CANopen connectivity. In some drives it is possible to use more than one SI-CANopen or a combination of SI-CANopen and other option modules to add additional functionality such as extended I/O, gateway functionality, or additional PLC features.

Figure 2-3 SI-CANopen for Unidrive M



2.3 General specification

SI-CANopen has been designed to offer as much flexibility as possible, in particular the PDO numbering system has been specifically designed to offer maximum versatility while maintaining conformance to CiA specifications.

- Supported data rates (bits/s): 1M, 800k, 500k, 250k, 125k, 100k and 50k.
- Four transmit and four receive PDOs (process data objects) A, B, C and D supported.
- Independently configurable transmit and receive PDO numbers (1-511) for maximum application flexibility.
- All synchronous and asynchronous PDO communication modes supported.
- Total of 32 bytes (16 words) in each direction using PDOs (4 TxPDOs of 64 bits and four RxPDOs of 64 bits).
- Service Data Objects (SDO) provide access to all drive and option modules.
- Consumer heartbeat.
- Emergency message completed flag.
- D-type connection for ease of wiring.
- RxPDO, SYNC and missed heartbeat event handling.
- RxPDO event triggers.
- TxPDO event triggers.
- Object association for un-defined DSP-402 objects.
- +24 V back-up power supply capability.

2.4 Option module identification

The SI-CANopen module is identified by:

1. The label located on the underside of the option module.
2. The color coding across the front of the SI-CANopen (light grey).

Figure 2-4 SI-CANopen label

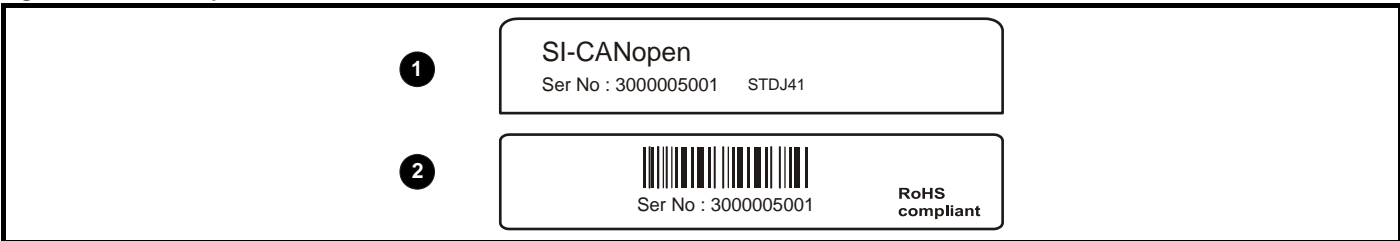

1 Topside module label

2 Underside module label

2.4.1 Date code format

The date code is split into two sections: a letter followed by a number.

The letter indicates the year, and the number indicates the week number (within the year) in which the option module was built.

The letters are in alphabetical order, starting with A in 1990 (B in 1991, C in 1992 etc.).

Example:

A date code of R15 would correspond to week 15 of year 2008.

2.5 Conventions used in this guide

The configuration of the host drive and option module is done using menus and parameters. A menu is a logical collection of parameters that have similar functionality. In the case of an options module, the parameters will appear in menu 15, 16 or 17 depending on which slot the module is installed to. The menu is determined by the number before the decimal point.

The method used to determine the menu or parameter is as follows:

- Pr **S.mm.ppp** - Where S signifies the option module slot number and mm.ppp signifies the menu and parameter number of the option module's internal menus and parameters.
- Pr **MM.ppp** - Where MM signifies the menu allocated to the option module set-up menu and ppp signifies the parameter number.
- Pr **mm.000** - Signifies parameter number 000 in any drive menu.

2.6 Conventions used for SI-CANopen

When referring to PDOs (process data objects), a PDO normally refers to both TxPDO (transmit process data object) and RxPDO (receive process data object). Where the differences are important this is quantified using the terms TxPDO and RxPDO.

SI-CANopen references PDOs by a letter (A, B, C & D) to differentiate between the configuration of the PDOs and the actual PDO numbers used. SI-CANopen supports four TxPDOs (A, B, C & D) and four RxPDOs (A, B, C & D) these PDOs have the default PDO numbers of 1, 3, 5 & 6 respectively, however these may be configured to any valid PDO number using a master.

3 Mechanical installation



Before installing or removing an option module from any drive, ensure the AC supply has been disconnected for at least 10 minutes and refer to section 1 *Safety information* on page 4. If using a DC bus supply ensure this is fully discharged before working on any drive or option module.

3.1 General installation

The installation of an option module is illustrated in Figure 3-1.

Figure 3-1 Installing an option module

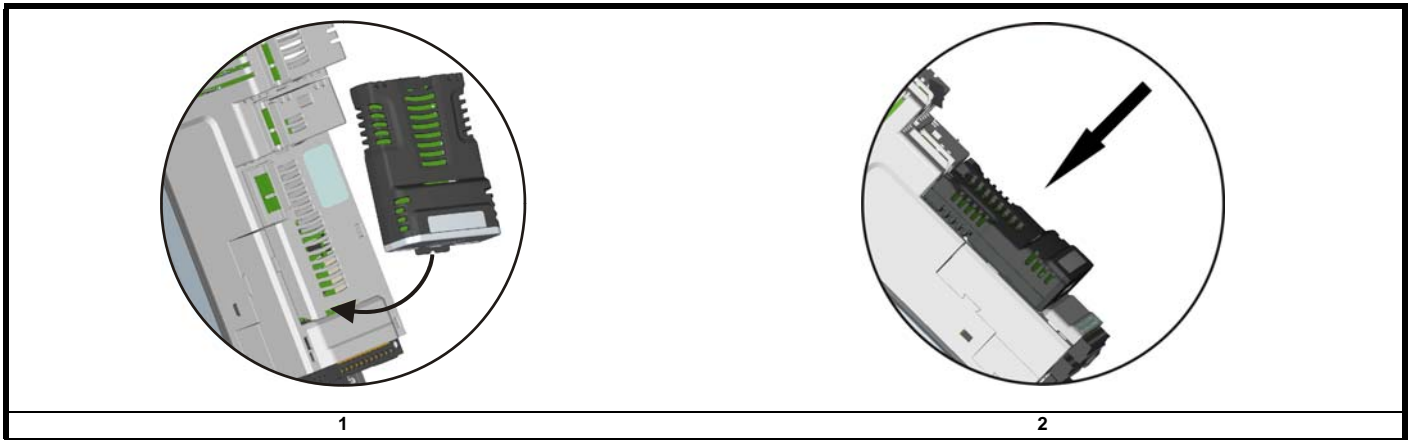

3.1.1 Installing the first option module

- Option module slots must be used in the following order: slot 3, slot 2 and slot 1. Orientate the option module above the drive as shown in (1).
- Align and insert the option module tab into the slot (2). Press down on the option module until it clicks into place.

4 Electrical

4.1 SI-CANopen terminal descriptions

SI-CANopen has a standard 9-way D-type connector for the SI-CANopen network as shown in Figure 4-1.

Figure 4-1 SI-CANopen - connector view

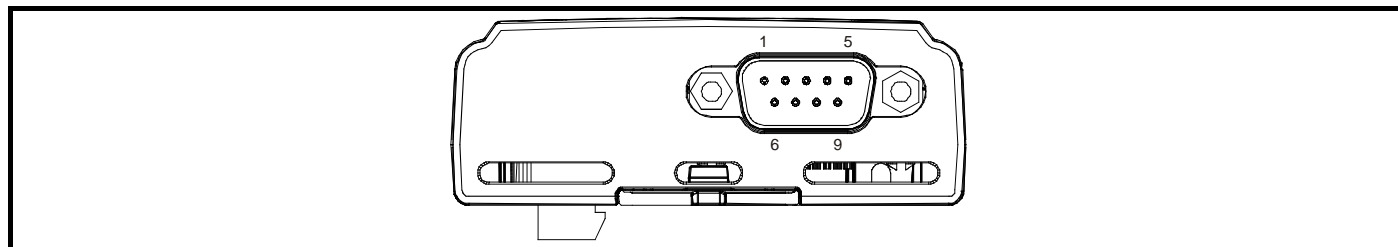

Table 4-1 SI-CANopen terminal descriptions

9-way D-type	Function	Description
6	0 V	0 V CANopen external supply
2	CAN-L	Negative data line
3,5,Shell	Shield	Cable braided shield connection
7	CAN-H	Positive data line
9	+24 V	+24 V CANopen external supply

Any external supply must be suitably installed to prevent noise on the network. Connecting pins 6 and 9 to an external supply allows the line driver circuitry to remain powered when the drive and the SI-CANopen module are turned off. This 24 V input does not allow SI-CANopen to continue communicating.

NOTE

The external supply terminals provide power for the SI-CANopen transceiver circuitry, but do NOT provide power to keep the SI-CANopen operating in the event of the mains power supply loss to the drive. An external supply will keep the SI-CANopen transceivers powered up and the network load characteristics constant in the event of loss of power to the drive.



Any external supply must be suitably installed to prevent noise on the network. Connecting pins 6 and 9 to an external supply allows the line driver circuitry to remain powered when the drive and the SI-CANopen module are turned off. This 24 V input does not allow SI-CANopen to continue communicating.

4.2 CANopen cable

CANopen cable has 2 twisted pairs plus an overall shielding. SI-CANopen has a specified color code, and it is important that this code is maintained. The data wires are white and blue, and the network power supply wires are red and black.

Table 4.2 CANopen cable color codes

Terminal	Cable	Data signal	Description
6	Black	0V	0 V external power supply
2	Blue	CAN-L	Negative data line
3, 5, Shell	Braided Shield	Shield	Cable shield
7	White	CAN-H	Positive data line
9	Red	+24 V	+24 V external power supply

CANopen networks run at high data rates and require cable specifically designed to carry high frequency signals. Low quality cable will attenuate the signals and may render the signal unreadable for the other nodes on the network. Cable specifications and a list of approved manufacturers of cable for use on CANopen networks is available on the CAN in Automation (CiA) web site at www.can-cia.org.

NOTE Control Techniques can only guarantee correct and reliable operation of SI-CANopen if all other equipment installed on the CANopen network (including the network cable) has been approved by the CiA.

4.3 CANopen network termination

It is very important in high-speed communications networks that the network communications cable is installed with the specified termination resistor network at each end of the cable segment. This prevents signals from being reflected back down the cable and causing interference.

During installation of a CANopen network, 120 Ω 0.25 W termination resistors should be installed across the CAN-H and CAN-L lines at both ends of the network segment.

NOTE Failure to terminate a network correctly can seriously affect the operation of the network. If the correct termination resistors are not installed, the noise immunity of the network is greatly reduced.

If too many termination resistors are installed on a CANopen network, the network will be over-loaded, resulting in reduced signal levels. This may cause nodes to miss some bits of information, resulting in potential transmission errors.

4.4 SI-CANopen cable shield connections

The SI-CANopen should be wired with the cable shields isolated from ground at each drive. The cable shields should be linked together at the point where they emerge from the cable, and formed into a short pigtail to be connected to the shell on the SI-CANopen connector.

NOTE The CANopen cable can be tie-wrapped to the grounding bar or local convenient mounting that is not live to provide strain relief, but the CANopen cable shield must be kept isolated from ground at each node. The only exception to this is the CANopen ground point as described in section 4.5 below.

4.5 SI-CANopen ground point

The CANopen cable shield must be grounded AT ONE POINT only, usually near the centre point of the cable run. This is to prevent the cable shield from becoming live in the event of catastrophic failure of another device on the CANopen network.

4.6 Maximum network length

The maximum number of nodes that can be connected to a single CANopen network segment is 32. The maximum length of network cable for a CANopen network is specified by the (*CAN in Automation (CiA)*) and depends on the data rate to be used.

Table 4-2 CANopen maximum segment lengths

Data rate (bits/sec)	Maximum network length (m)
1 M	30
800 k	50
500 k	100
250 k	250
125 k	500
100 k	700
50 k	1000

4.7 Spurs

Control Techniques do not recommend the use of spurs on a CANopen network.

For more detailed information please consult the CiA at www.can-cia.org.

4.8 Minimum node to node cable length

The CANopen specification does not specify a minimum node to node distance, however, Control Techniques advises a minimum distance of 1 m (3.3 ft) between nodes to prevent excessive mechanical stress and to reduce network reflections.

5 Getting Started

This section is intended to provide a generic guide for setting up SI-CANopen and a master controller/PLC. Figure 5-1 *PDO Configuration overview* on page 20 is intended as the starting point for a new installation. The following pages detail the various methods available to configure SI-CANopen. It is recommended that all of this section is read, before attempting to configure a system.

NOTE It is recommended that the latest firmware is used where possible to ensure all features are supported.

NOTE Due to the large number of different PLCs/masters that support SI-CANopen, details cannot be provided for any specific master or PLC. Generic support is available through your supplier or local drive centre. Before contacting your supplier or local drive centre for support ensure you have read Chapter 12 *Diagnostics* on page 108 of this manual and check you have configured all parameters correctly.

Ensure the following information is available before calling:

- A list of all parameters in SI-CANopen
- The drive firmware version (see the *drive documentation*)
- The SI-CANopen firmware version

5.1 Parameter save and restore

Parameters in the module are saved when a normal drive parameter save is initiated by selecting "Save Parameters" or setting a value of 1000 in Pr **mm.000** and performing a drive reset. (If the drive is in the under voltage state or is supplied from a low voltage power supply then a value of 1001 must be set in Pr **mm.000** and a drive reset performed).

Any user-saved parameters in the option module's internal menus are stored in non-volatile memory on the module and not in the drive. Therefore, if the module is moved to a different slot or to a different drive, then any saved parameter values will follow the module. If a module is to be replaced, ensure that the parameter values for the module have been backed up before replacing it.

5.2 Module reset

A reset of the SI-CANopen module can be performed by the methods detailed below.

- Set Pr **S.00.007** (or Pr **MM.007**) to On (1). This will only reset the module in slot S.
- Select "Reset modules" or set a value of 1070 in Pr **mm.000**, and performing a drive reset. This will perform a reset of all option modules installed in the drive.

5.3 Restoring module parameter default values

Setting Pr **S.00.008** (or Pr **MM.008**) to On (1) and performing a module reset will return all parameters in the SI-CANopen module to their default values.

Parameters in the SI-CANopen module will also be set to their default values when drive parameters are returned to their default values.

5.4 Single Line Parameters

Parameter		Range (⌘)		Default (⇒)		Type				
S.00.001	Module ID	0 to 65535				RO	Num	ND	NC	PT
S.00.002	Software Version	00.00.00.00 to 99.99.99.99				RO	Ver	ND	NC	PT
S.00.003	Hardware Version	00.00 to 99.99				RO	Ver	ND	NC	PT
S.00.004	Serial Number LS	0 to 99999999				RO	Num	ND	NC	PT
S.00.005	Serial Number MS	0 to 99999999				RO	Num	ND	NC	PT
S.00.006	Module Status	Initialising (0), OK (1), Config (2), Error (3)				RO	Txt	ND	NC	PT
S.00.007	Module reset	Off (0) or On (1)		Off (0)		RW	Bit		NC	
S.00.008	Module Default	Off (0) or On (1)		Off (0)		RW	Bit		NC	

RW	Read / Write	RO	Read-only	Bit	Bit parameter	Txt	Text string	Date	Date parameter	Time	Time parameter
Chr	Character parameter	Bin	Binary parameter	IP	IP address	Mac	MAC address	Ver	Version number	SMP	Slot, menu, parameter
Num	Number parameter	DE	Destination	ND	No default value	RA	Rating dependent	NC	Non-copyable	PT	Protected
FI	Filtered	US	User save	PS	Power-down save						

5.4.1 Menu 1 - SI-CANopen Setup

Parameter		Range (⇅)	Default (⇒)	Type									
S.01.001	Enable SI-CANopen Interface	Off (0) or On (1)	On (1)	RO	Bit								
S.01.002	Reset SI-CANopen Interface	Off (0) or On (1)	Off (0)	RW	Bit								
S.01.003	Default SI-CANopen Interface	Off (0) or On (1)	Off (0)	RW	Bit								
S.01.004	SI-CANopen Node Address	0 to 127	0	RW	Num								US
S.01.005	Baud rate	1Mbps (0), 800kbps (1), 500kbps (2), 250kbps (3), 125kbps (4), 50kbps (5), Auto detect (6)	500kbps (2)	RW	Txt		NC	PT					US
S.01.006	SI-CANopen Network Diagnostic	Network OK (0), Internal HW Fail (1), Init OK (2), Network No Data (3), Config Error (4), Software Error (5), Baud detecting (6), Device Disabled (7), Initialise Delay (8)		RO	Txt	ND	NC	PT					
S.01.007	Cyclic Data Rate	0 to 9999 Messages/s		RO	Num	ND	NC	PT					
S.01.008	PDO Configuration Source	By Menu (0), By Master (1)	By Menu (0)	RW	Txt								US
S.01.010	Timeout Delay	0 to 3000 ms	0 ms	RW	Num								US
S.01.011	Timeout Action	Trip (0), Send flt values (1), Clear output (2), Hold last (3), No action (4)	Trip (0)	RW	Txt								US
S.01.012	Timeout Event Destination	This slot (0), Slot 1 (1), Slot 2 (2), Slot 3 (3), Slot 4 (4)	This slot (0)	RW	Txt								US
S.01.013	Timeout Event Type	No event (0), Event 0 (1), Event1 (2), Event2 (3), Event3 (4), Event4 (5)	No event (0)	RW	Txt								US
S.01.014	Data Alignment	32 (0), 16 (1)	32 (0)	RW	Txt								US
S.01.020	DSP402 Enable	Off (0) or On (1)	Off (0)	RW	Bit								US
S.01.021	Compatibility Mode	UNIDRIVE M (0), UNIDRIVE SP (1)	UNIDRIVE M (0)	RW	Txt								US
S.01.022	Compatibility Mode Software Revision	00.00.00.00 to 99.99.99.99	00.00.00.00	RW	Ver								US
S.01.023	Compatibility Mode Serial Number	0 to 999999999	0	RW	Num								US

RW	Read / Write	RO	Read-only	Bit	Bit parameter	Txt	Text string	Date	Date parameter	Time	Time parameter
Chr	Character parameter	Bin	Binary parameter	IP	IP address	Mac	MAC address	Ver	Version number	SMP	Slot, menu, parameter
Num	Number parameter	DE	Destination	ND	No default value	RA	Rating dependent	NC	Non-copyable	PT	Protected
FI	Filtered	US	User save	PS	Power-down save						

5.4.2 Menu 2 - PDOA Setup

Parameter		Range (⇅)	Default (⇒)	Type									
S.02.001	TPDOA Length	0 to 4	4	RW	Num		NC						
S.02.002	RPDOA Length	0 to 4	4	RW	Num		NC						
S.02.003	TPDOA Transmission Type	0 to 255	255	RW	Num								
S.02.004	TPDOA Mapping Status	Mapping OK (0), Too Many Map (1), No Mapping (2), Read Mismatch (3), Hole In Mapping (4), Duplicate Map (5), Length Mismatch (6), DSP402 Align (7), Trans Type (8)	Mapping OK (0)	RO	Txt		NC	PT					
S.02.005	RPDOA Mapping Status	Mapping OK (0), Too Many Map (1), No Mapping (2), Read Mismatch (3), Hole In Mapping (4), Duplicate Map (5), Length Mismatch (6), DSP402 Align (7), Trans Type (8)	Mapping OK (0)	RO	Txt		NC	PT					
S.02.006	TPDOA Processing Time	0 to 65535 ms		RO	Num	ND	NC	PT					
S.02.007	RPDOA Processing Time	0 to 65535 ms		RO	Num	ND	NC	PT					
S.02.008	PDOA Input Consistency Enable	Off (0) or On (1)	Off (0)	RW	Bit								US
S.02.009	PDOA Input Consistency Trigger Parameter	0.00.000 to 5.99.999	0.00.000	RW	SMP								US
S.02.010	PDOA Output Consistency Enable	Off (0) or On (1)	Off (0)	RW	Bit								US
S.02.011	PDOA Output Consistency Trigger Parameter	0.00.000 to 5.99.999	0.00.000	RW	SMP								US
S.02.012	PDOA Event Trigger	Off (0) or On (1)	Off (0)	RW	Bit								US
S.02.013	TPDOA Number	0 to 512	1	RW	Num								US
S.02.014	RPDOA Number	0 to 512	1	RW	Num								US
S.02.015	TPDOA Mapping Parameter 1	0.00.000 to 5.99.999	0.10.040	RW	SMP								US
S.02.016	TPDOA Mapping Parameter 2	0.00.000 to 5.99.999	0.02.001	RW	SMP								US
S.02.017	TPDOA Mapping Parameter 3	0.00.000 to 5.99.999	0.00.000	RW	SMP								US
S.02.018	TPDOA Mapping Parameter 4	0.00.000 to 5.99.999	0.00.000	RW	SMP								US
S.02.019	RPDOA Mapping Parameter 1	0.00.000 to 5.99.999	0.06.042	RW	SMP								US
S.02.020	RPDOA Mapping Parameter 2	0.00.000 to 5.99.999	0.01.021	RW	SMP								US
S.02.021	RPDOA Mapping Parameter 3	0.00.000 to 5.99.999	0.00.000	RW	SMP								US
S.02.022	RPDOA Mapping Parameter 4	0.00.000 to 5.99.999	0.00.000	RW	SMP								US

RW	Read / Write	RO	Read-only	Bit	Bit parameter	Txt	Text string	Date	Date parameter	Time	Time parameter
Chr	Character parameter	Bin	Binary parameter	IP	IP address	Mac	MAC address	Ver	Version number	SMP	Slot, menu, parameter
Num	Number parameter	DE	Destination	ND	No default value	RA	Rating dependent	NC	Non-copyable	PT	Protected
Fl	Filtered	US	User save	PS	Power-down save						

5.4.3 Menu 3 - PDOB Setup

Parameter		Range (⌘)		Default (⇒)		Type						
S.03.001	TPDOB Length	0 to 4		4		RW	Num		NC			
S.03.002	RPDOB Length	0 to 4		4		RW	Num		NC			
S.03.003	TPDOB Transmission Type	0 to 255		255		RW	Num					
S.03.004	TPDOB Mapping Status	Mapping OK (0), Too Many Map (1), No Mapping (2), Read Mismatch (3), Hole In Mapping (4), Duplicate Map (5), Length Mismatch (6), DSP402 Align (7), Trans Type (8)		Mapping OK (0)		RO	Txt		NC	PT		
S.03.005	RPDOB Mapping Status	Mapping OK (0), Too Many Map (1), No Mapping (2), Read Mismatch (3), Hole In Mapping (4), Duplicate Map (5), Length Mismatch (6), DSP402 Align (7), Trans Type (8)		Mapping OK (0)		RO	Txt		NC	PT		
S.03.006	TPDOB Processing Time	0 to 65535 ms				RO	Num	ND	NC	PT		
S.03.007	RPDOB Processing Time	0 to 65535 ms				RO	Num	ND	NC	PT		
S.03.008	PDOB Input Consistency Enable	Off (0) or On (1)		Off (0)		RW	Bit					US
S.03.009	PDOB Input Consistency Trigger Parameter	0.00.000 to 5.99.999		0.00.000		RW	SMP					US
S.03.010	PDOB Output Consistency Enable	Off (0) or On (1)		Off (0)		RW	Bit					US
S.03.011	PDOB Output Consistency Trigger Parameter	0.00.000 to 5.99.999		0.00.000		RW	SMP					US
S.03.012	PDOB Event Trigger	Off (0) or On (1)		Off (0)		RW	Bit					US
S.03.013	TPDOB Number	0 to 512		3		RW	Num					US
S.03.014	RPDOB Number	0 to 512		3		RW	Num					US
S.03.015	TPDOB Mapping Parameter 1	0.00.000 to 5.99.999		0.00.000		RW	SMP					US
S.03.016	TPDOB Mapping Parameter 2	0.00.000 to 5.99.999		0.00.000		RW	SMP					US
S.03.017	TPDOB Mapping Parameter 3	0.00.000 to 5.99.999		0.00.000		RW	SMP					US
S.03.018	TPDOB Mapping Parameter 4	0.00.000 to 5.99.999		0.00.000		RW	SMP					US
S.03.019	RPDOB Mapping Parameter 1	0.00.000 to 5.99.999		0.00.000		RW	SMP					US
S.03.020	RPDOB Mapping Parameter 2	0.00.000 to 5.99.999		0.00.000		RW	SMP					US
S.03.021	RPDOB Mapping Parameter 3	0.00.000 to 5.99.999		0.00.000		RW	SMP					US
S.03.022	RPDOB Mapping Parameter 4	0.00.000 to 5.99.999		0.00.000		RW	SMP					US

RW	Read / Write	RO	Read-only	Bit	Bit parameter	Txt	Text string	Date	Date parameter	Time	Time parameter
Chr	Character parameter	Bin	Binary parameter	IP	IP address	Mac	MAC address	Ver	Version number	SMP	Slot, menu, parameter
Num	Number parameter	DE	Destination	ND	No default value	RA	Rating dependent	NC	Non-copyable	PT	Protected
FI	Filtered	US	User save	PS	Power-down save						

5.4.4 Menu 4 - PDOC Setup

Parameter		Range (⇅)	Default (⇄)	Type			
S.04.001	TPDOC Length	0 to 4	4	RW	Num		NC
S.04.002	RPDOC Length	0 to 4	4	RW	Num		NC
S.04.003	TPDOC Transmission Type	0 to 255	255	RW	Num		
S.04.004	TPDOC Mapping Status	Mapping OK (0), Too Many Map (1), No Mapping (2), Read Mismatch (3), Hole In Mapping (4), Duplicate Map (5), Length Mismatch (6), DSP402 Align (7), Trans Type (8)	Mapping OK (0)	RO	Txt		NC PT
S.04.005	RPDOC Mapping Status	Mapping OK (0), Too Many Map (1), No Mapping (2), Read Mismatch (3), Hole In Mapping (4), Duplicate Map (5), Length Mismatch (6), DSP402 Align (7), Trans Type (8)	Mapping OK (0)	RO	Txt		NC PT
S.04.006	TPDOC Processing Time	0 to 65535 ms		RO	Num	ND	NC PT
S.04.007	RPDOC Processing Time	0 to 65535 ms		RO	Num	ND	NC PT
S.04.008	PDOC Input Consistency Enable	Off (0) or On (1)	Off (0)	RW	Bit		US
S.04.009	PDOC Input Consistency Trigger Parameter	0.00.000 to 5.99.999	0.00.000	RW	SMP		US
S.04.010	PDOB Output Consistency Enable	Off (0) or On (1)	Off (0)	RW	Bit		US
S.04.011	PDOC Output Consistency Trigger Parameter	0.00.000 to 5.99.999	0.00.000	RW	SMP		US
S.04.012	PDOC Event Trigger	Off (0) or On (1)	Off (0)	RW	Bit		US
S.04.013	TPDOC Number	0 to 512	5	RW	Num		US
S.04.014	RPDOC Number	0 to 512	5	RW	Num		US
S.04.015	TPDOC Mapping Parameter 1	0.00.000 to 5.99.999	0.00.000	RW	SMP		US
S.04.016	TPDOC Mapping Parameter 2	0.00.000 to 5.99.999	0.00.000	RW	SMP		US
S.04.017	TPDOC Mapping Parameter 3	0.00.000 to 5.99.999	0.00.000	RW	SMP		US
S.04.018	TPDOC Mapping Parameter 4	0.00.000 to 5.99.999	0.00.000	RW	SMP		US
S.04.019	RPDOC Mapping Parameter 1	0.00.000 to 5.99.999	0.00.000	RW	SMP		US
S.04.020	RPDOC Mapping Parameter 2	0.00.000 to 5.99.999	0.00.000	RW	SMP		US
S.04.021	RPDOC Mapping Parameter 3	0.00.000 to 5.99.999	0.00.000	RW	SMP		US
S.04.022	RPDOC Mapping Parameter 4	0.00.000 to 5.99.999	0.00.000	RW	SMP		US

RW	Read / Write	RO	Read-only	Bit	Bit parameter	Txt	Text string	Date	Date parameter	Time	Time parameter
Chr	Character parameter	Bin	Binary parameter	IP	IP address	Mac	MAC address	Ver	Version number	SMP	Slot, menu, parameter
Num	Number parameter	DE	Destination	ND	No default value	RA	Rating dependent	NC	Non-copyable	PT	Protected
Fl	Filtered	US	User save	PS	Power-down save						

5.4.5 Menu 5 - PDOD Setup

Parameter		Range (⇅)	Default (⇒)	Type									
S.05.001	TPDOD Length	0 to 4	4	RW	Num		NC						
S.05.002	RPDOD Length	0 to 4	4	RW	Num		NC						
S.05.003	TPDOD Transmission Type	0 to 255	255	RW	Num								
S.05.004	TPDOD Mapping Status	Mapping OK (0), Too Many Map (1), No Mapping (2), Read Mismatch (3), Hole In Mapping (4), Duplicate Map (5), Length Mismatch (6), DSP402 Align (7), Trans Type (8)	Mapping OK (0)	RO	Txt		NC	PT					
S.05.005	RPDOD Mapping Status	Mapping OK (0), Too Many Map (1), No Mapping (2), Read Mismatch (3), Hole In Mapping (4), Duplicate Map (5), Length Mismatch (6), DSP402 Align (7), Trans Type (8)	Mapping OK (0)	RO	Txt		NC	PT					
S.05.006	TPDOD Processing Time	0 to 65535 ms		RO	Num	ND	NC	PT					
S.05.007	RPDOD Processing Time	0 to 65535 ms		RO	Num	ND	NC	PT					
S.05.008	PDOD Input Consistency Enable	Off (0) or On (1)	Off (0)	RW	Bit								US
S.05.009	PDOD Input Consistency Trigger Parameter	0.00.000 to 5.99.999	0.00.000	RW	SMP								US
S.05.010	PDOD Output Consistency Enable	Off (0) or On (1)	Off (0)	RW	Bit								US
S.05.011	PDOD Output Consistency Trigger Parameter	0.00.000 to 5.99.999	0.00.000	RW	SMP								US
S.05.012	PDOD Event Trigger	Off (0) or On (1)	Off (0)	RW	Bit								US
S.05.013	TPDOD Number	0 to 512	6	RW	Num								US
S.05.014	RPDOD Number	0 to 512	6	RW	Num								US
S.05.015	TPDOD Mapping Parameter 1	0.00.000 to 5.99.999	0.00.000	RW	SMP								US
S.05.016	TPDOD Mapping Parameter 2	0.00.000 to 5.99.999	0.00.000	RW	SMP								US
S.05.017	TPDOD Mapping Parameter 3	0.00.000 to 5.99.999	0.00.000	RW	SMP								US
S.05.018	TPDOD Mapping Parameter 4	0.00.000 to 5.99.999	0.00.000	RW	SMP								US
S.05.019	RPDOD Mapping Parameter 1	0.00.000 to 5.99.999	0.00.000	RW	SMP								US
S.05.020	RPDOD Mapping Parameter 2	0.00.000 to 5.99.999	0.00.000	RW	SMP								US
S.05.021	RPDOD Mapping Parameter 3	0.00.000 to 5.99.999	0.00.000	RW	SMP								US
S.05.022	RPDOD Mapping Parameter 4	0.00.000 to 5.99.999	0.00.000	RW	SMP								US

RW	Read / Write	RO	Read-only	Bit	Bit parameter	Txt	Text string	Date	Date parameter	Time	Time parameter
Chr	Character parameter	Bin	Binary parameter	IP	IP address	Mac	MAC address	Ver	Version number	SMP	Slot, menu, parameter
Num	Number parameter	DE	Destination	ND	No default value	RA	Rating dependent	NC	Non-copyable	PT	Protected
Fl	Filtered	US	User save	PS	Power-down save						

5.4.6 Menu 6 - RPDO Menu Fault

Parameter		Range (⇅)	Default (⇒)	Type					
S.06.001	PDOA Fault Value 1	-2147483648 to 2147483647	0	RW	Num				US
S.06.002	PDOA Fault Value 2	-2147483648 to 2147483647	0	RW	Num				US
S.06.003	PDOA Fault Value 3	-2147483648 to 2147483647	0	RW	Num				US
S.06.004	PDOA Fault Value 4	-2147483648 to 2147483647	0	RW	Num				US
S.06.005	PDOB Fault Value 1	-2147483648 to 2147483647	0	RW	Num				US
S.06.006	PDOB Fault Value 2	-2147483648 to 2147483647	0	RW	Num				US
S.06.007	PDOB Fault Value 3	-2147483648 to 2147483647	0	RW	Num				US
S.06.008	PDOB Fault Value 4	-2147483648 to 2147483647	0	RW	Num				US
S.06.009	PDOC Fault Value 1	-2147483648 to 2147483647	0	RW	Num				US
S.06.010	PDOC Fault Value 2	-2147483648 to 2147483647	0	RW	Num				US
S.06.011	PDOC Fault Value 3	-2147483648 to 2147483647	0	RW	Num				US
S.06.012	PDOC Fault Value 4	-2147483648 to 2147483647	0	RW	Num				US
S.06.013	PDOD Fault Value 1	-2147483648 to 2147483647	0	RW	Num				US
S.06.014	PDOD Fault Value 2	-2147483648 to 2147483647	0	RW	Num				US
S.06.015	PDOD Fault Value 3	-2147483648 to 2147483647	0	RW	Num				US
S.06.016	PDOD Fault Value 4	-2147483648 to 2147483647	0	RW	Num				US

RW	Read / Write	RO	Read-only	Bit	Bit parameter	Txt	Text string	Date	Date parameter	Time	Time parameter
Chr	Character parameter	Bin	Binary parameter	IP	IP address	Mac	MAC address	Ver	Version number	SMP	Slot, menu, parameter
Num	Number parameter	DE	Destination	ND	No default value	RA	Rating dependent	NC	Non-copyable	PT	Protected
Fl	Filtered	US	User save	PS	Power-down save						

5.4.7 Menu 9 - Resources

Parameter		Range (⇅)	Default (⇒)	Type					
S.09.030	PCB Temperature 1	-128 to 127 °C		RO	Num	ND	NC	PT	
S.09.031	PCB Temperature 2	-128 to 127 °C		RO	Num	ND	NC	PT	

RW	Read / Write	RO	Read-only	Bit	Bit parameter	Txt	Text string	Date	Date parameter	Time	Time parameter
Chr	Character parameter	Bin	Binary parameter	IP	IP address	Mac	MAC address	Ver	Version number	SMP	Slot, menu, parameter
Num	Number parameter	DE	Destination	ND	No default value	RA	Rating dependent	NC	Non-copyable	PT	Protected
Fl	Filtered	US	User save	PS	Power-down save						

5.5 PDO number configuration

If a controller/PLC requires PDO numbering to be changed (e.g. the only supported PDOs are 1,2,3 and 4), this can be achieved using object 0x2800 or 0x2801, doing this will result in the existing PDO configuration objects being destroyed and objects for the new PDO being created with default values, this will take effect immediately. If the PDO number is already used within the same object the old PDO will be overwritten. It is now possible to have different numbers for individual TxPDOs and RxPDOs eg. TxPDO 1, 2, 3, 4 and RxPDO 5, 6, 7 and 8.

5.5.1 Object 0x2800 (RxPDO number configuration)

Sub Index 0 : Will return 4 when read indicating the maximum sub-index and number of PDOs supported.

Sub Index 1 – 4 : Are used to read and set the RxPDO number for each of the four configurable RxPDOs. The number is specified as the required number less 1. That is, PDO1 would be represented as 0.

5.5.2 Object 0x2801 (TxPDO number configuration)

Sub Index 0 : Will return 4 when read indicating the maximum sub-index and number of PDOs supported.

Sub Index 1 – 4 : Are used to read and set the TxPDO number for each of the four configurable TxPDOs. The actual index number is calculated by subtracting 1 from the PDO number and adding this number to the base address (e.g. for PDO3 use 2).

5.6 PDO structure (PDOs A, B, C & D)

SI-CANopen provides four TxPDOs and four RxPDOs, these are referred to as PDOs A, B, C & D. By default these are configured as PDOs 1, 3, 5 & 6 respectively.

All PDOs may be configured entirely from the module's parameters without the need for a master. All PDOs can also be set up using SDOs from the master.

The benefits of using this scheme are that it allows the four PDOs (A, B, C and D) to be configured to any valid PDO number required while still achieving conformance.

5.7 Types of set-up

SI-CANopen offers several different methods of configuration that depend on the number of PDOs required and the type of controller/PLC involved.

5.7.1 Configuration by SI-CANopen parameters only (no master, single PDO)

Any PDO (PDOA) may be configured by using just the module's parameters. The default setting for the first PDO (PDOA) is TxPDO 1 and RxPDO1. All settings such as transmission type, TxPDO length, RxPDO length, TxPDO mappings and RxPDO mappings can be configured directly from the menu associated with SI-CANopen. This allows simple configuration, but is restricted to a single PDO.

NOTE The default transmission type, asynchronous timer trigger (type 255) for TxPDOA cannot be configured without a controller/PLC, as the SI-CANopen internal timer must be configured to use this feature. For use without a controller/PLC the transmission type should be changed. This default configuration prevents a partially configured node from transmitting on the network.

5.7.2 Configuration using the pre-configured PDOs by SDO (controller/PLC required)

The default SI-CANopen configuration supports PDOs A, B, C & D set to PDOs 1, 3, 5 & 6 respectively. In order to use all of these PDOs the configuration of the PDOs must be performed by the master (using SDOs) when the network starts.

5.7.3 Flexible PDO numbering (master required)

SI-CANopen provides a method of reconfiguring the available PDOs while still maintaining conformance (objects 0x2800 and 0x2801). This method allows four TxPDOs (A, B, C & D) and four RxPDOs (A, B, C & D) to be configured individually to any valid PDO number. It is not necessary for the TxPDOs and RxPDOs to have the same PDO numbers, thus allowing for absolute flexibility during configuration. The configuration objects for the configured PDOs are taken from the base address of the object (eg. 0x1800) plus the configured PDO number minus 1 (e.g. PDO2 would use 0x1801).

NOTE If an SDO overwrites the settings made in the module's parameters, then the values for the communication objects will be changed. However, the values stored in the parameters will not be altered.

5.7.4 SDO saving

A method for saving the configured PDOs is available by using object (0x1010), which allows all communication settings to be stored in SI-CANopen. This allows SI-CANopen to retain the settings sent by the configuration SDOs from the controller/PLC. The node is then able to resume communications without requiring the SDO configuration to be re-sent by the controller/PLC, following a reset or loss of power. This procedure does not perform a drive parameter save.

5.7.5 Pre-configuration for a machine (controller/PLC required initially)

The SDO saving option (0x1010) allows SI-CANopen to be pre-configured on a controller/PLC before use on a system. This allows the product to be configured for use with a controller/PLC that does not support SDO configuration of the slave device, or a controller/PLC that requires a specific set of PDO numbers. This effectively allows the module to be pre-configured before installation and allows SI-CANopen to work in existing hardware configurations with different PDO numbering schemes.

5.8 Configuration overview

Figure 5-1 *PDO Configuration overview* on page 20 gives an overview of the configuration process required for SI-CANopen communication objects, details are given for the key stages of set-up. In particular the stages involved in configuring PDO numbers (if required) and the required set-up parameters/objects are shown. Additional details of the objects can be found in the sections relating to the specific objects. It is recommended that all of this section is read before configuring SI-CANopen. This overview is supplemented by the set-up flowcharts that follow.

Figure 5-1 PDO Configuration overview

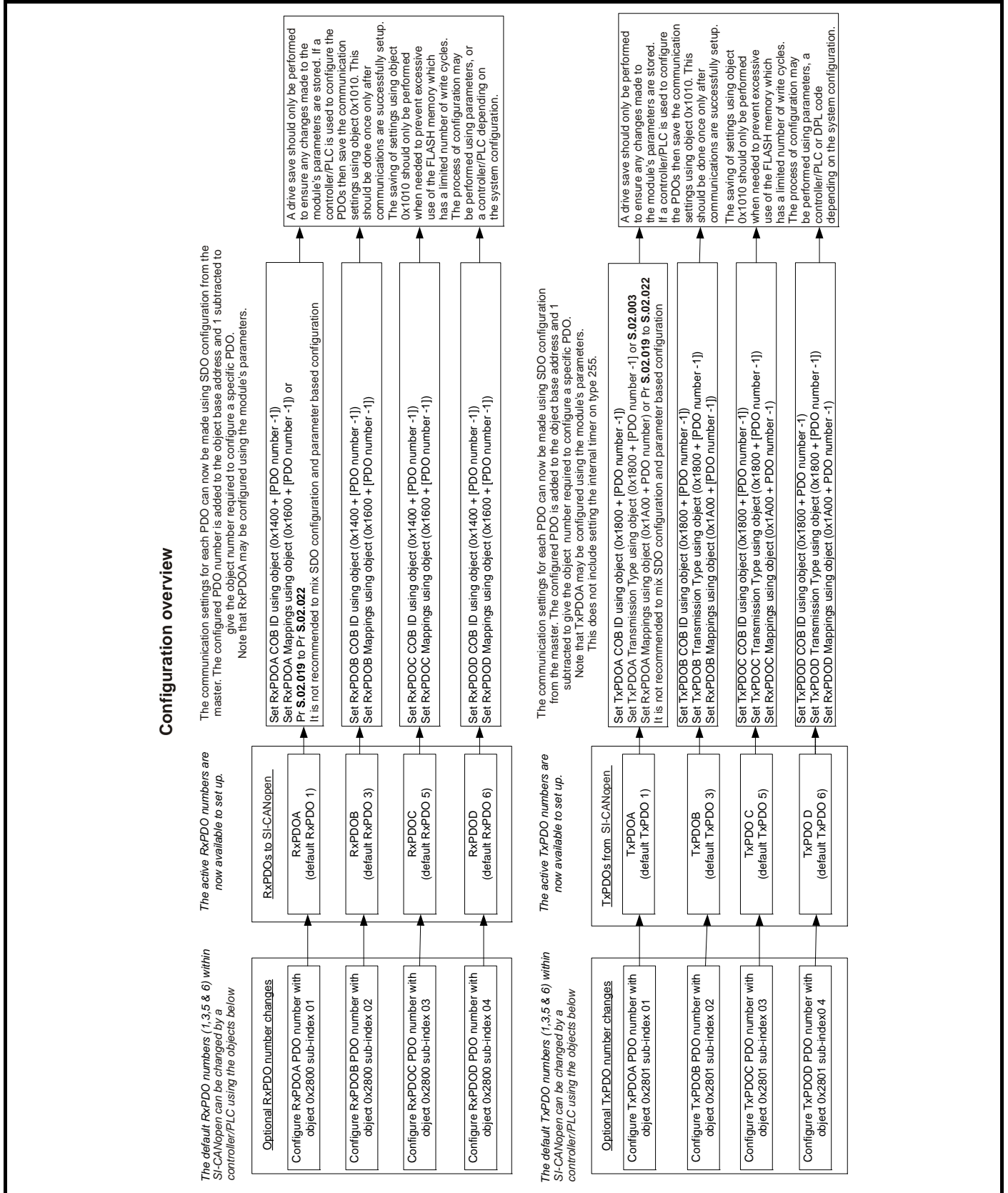

5.9 Setup flowcharts

The following flowcharts should be used as a visual reference to aid with the configuration of a network. Various options are highlighted by decision boxes and sub flowcharts are used to extend the detail within certain sections.

5.9.1 Cabling and addressing flowchart

Figure 5-2 details the requirements for cabling and addressing. This flowchart should be used as the starting point for all configurations.

Figure 5-2 Installation and addressing

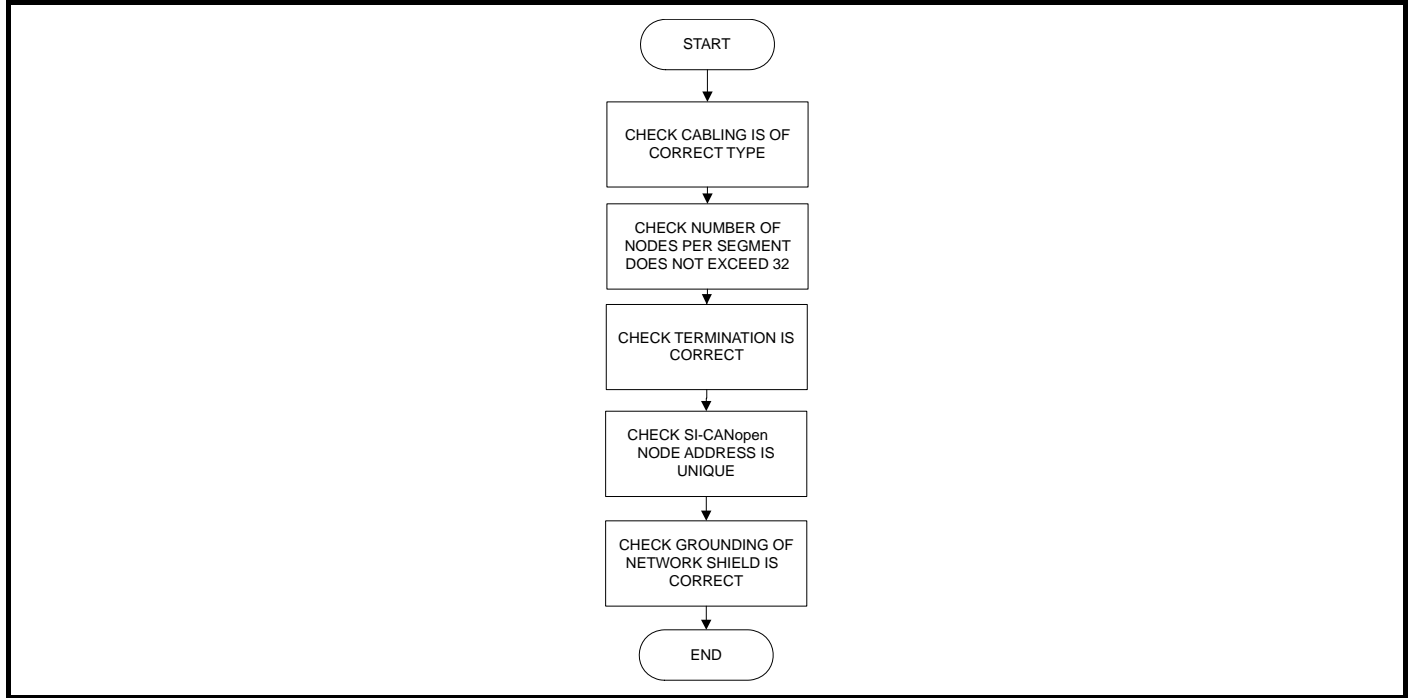

5.9.2 Configuring SI-CANopen

Figure 5-3 details the main setup procedure for the PDO settings on SI-CANopen. To break the procedure into manageable sections, additional sub flowcharts are referred to that expand the detail where necessary (always return to this flowchart after completion of a sub flowchart).

Figure 5-3 Configuration options flowchart

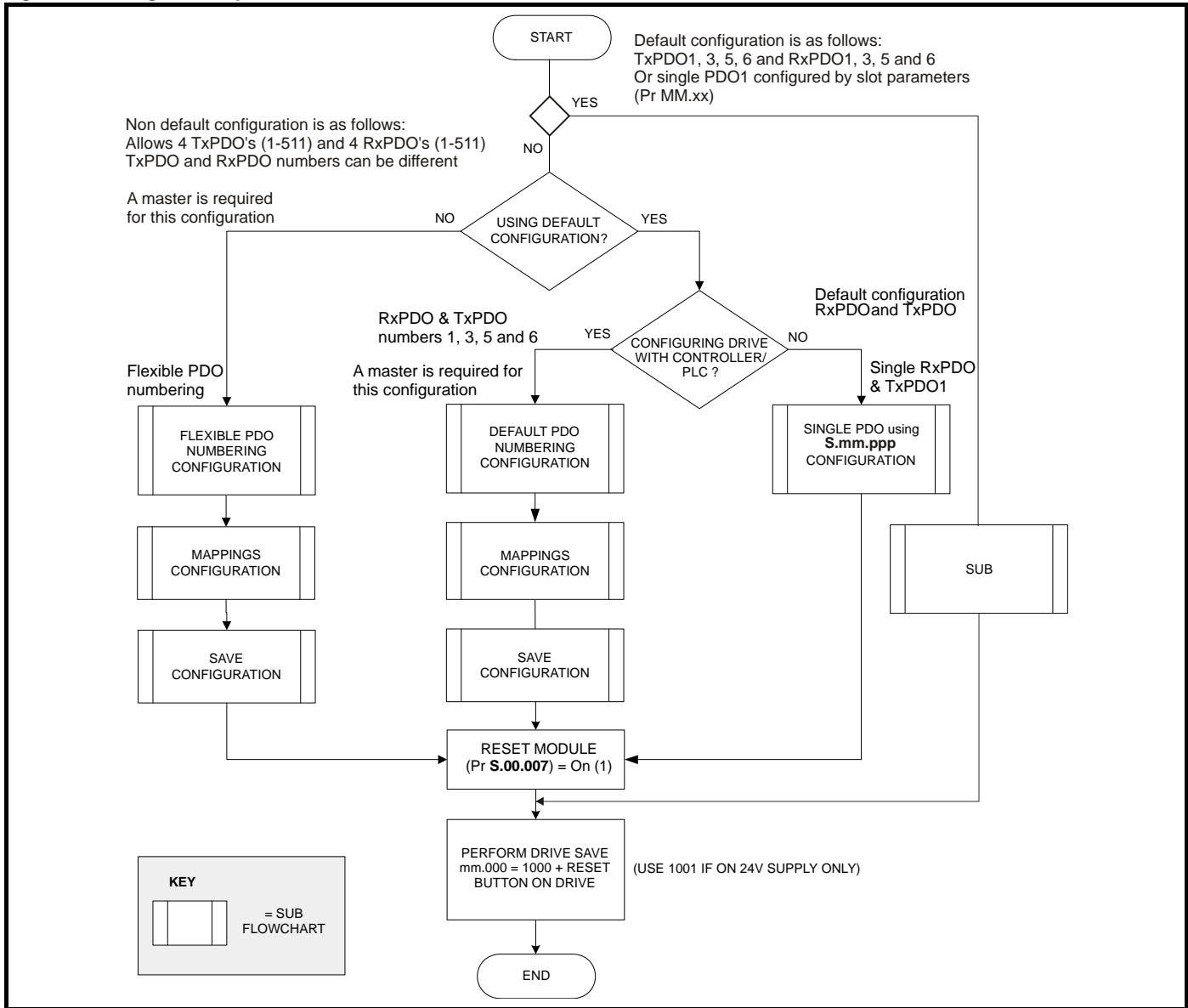

5.9.3 Single PDO configuration using drive parameters only

Figure 5-4 details the steps required to configure SI-CANopen for a single PDO (PDOA which by default is PDO1) using only the drive menus. This means that SI-CANopen does not require a master to configure any PDO. The default PDOs in the module are RxPDO 1, 3, 5 and 6.

Figure 5-4 Manual configuration flowchart

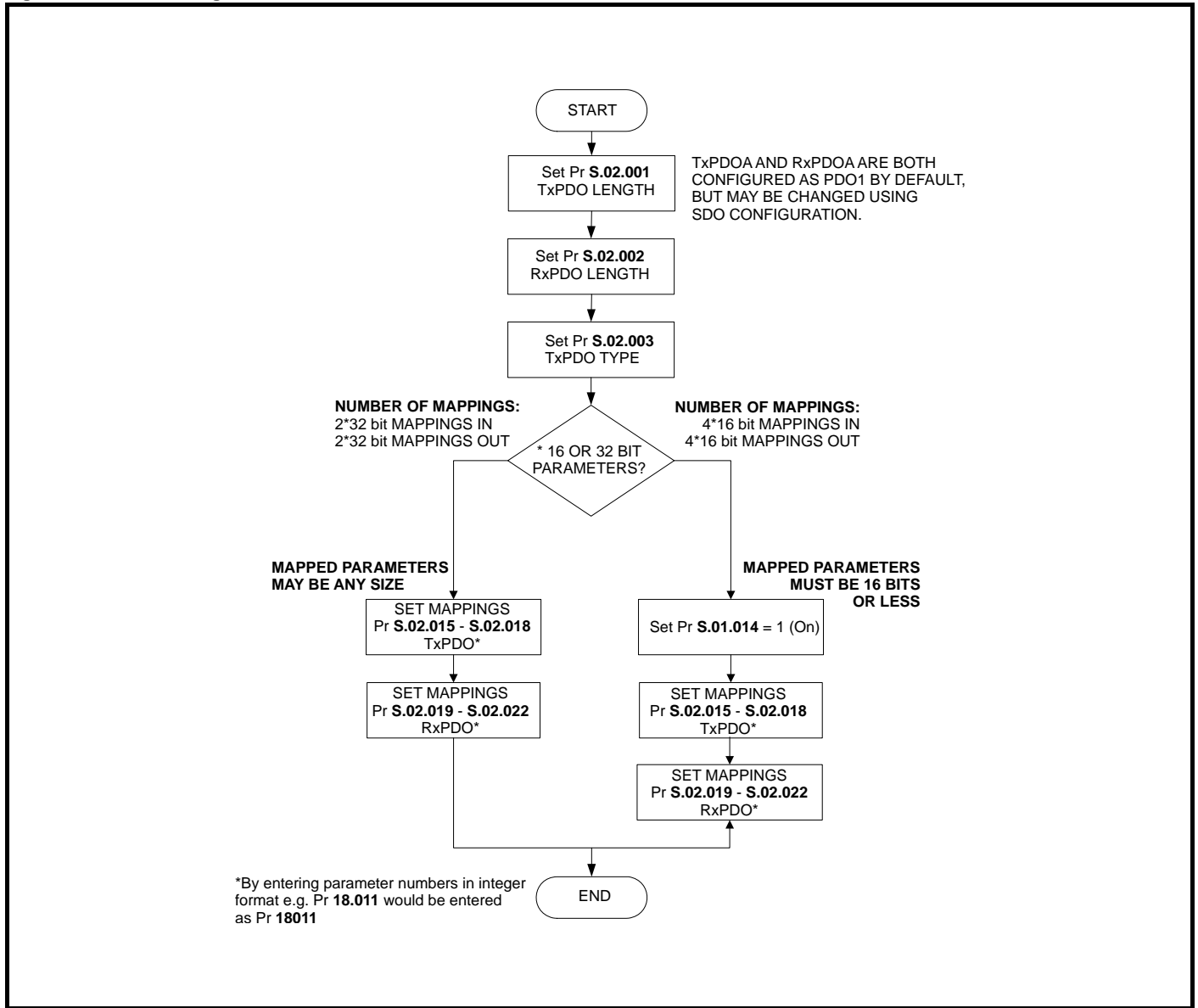

NOTE This chart is used in conjunction with Figure 5-3 Configuration options flowchart on page 22.

5.9.4 Configuration of default PDOs (using controller/PLC)

Figure 5-5 details the SDOs required to setup the default RxPDOs and TxPDOs contained within the module. The default PDOs in the module are RxPDOs 1, 3, 5 and 6 and TxPDOs 1, 3, 5 and 6.

Figure 5-5 Sub flowchart for default PDO numbering

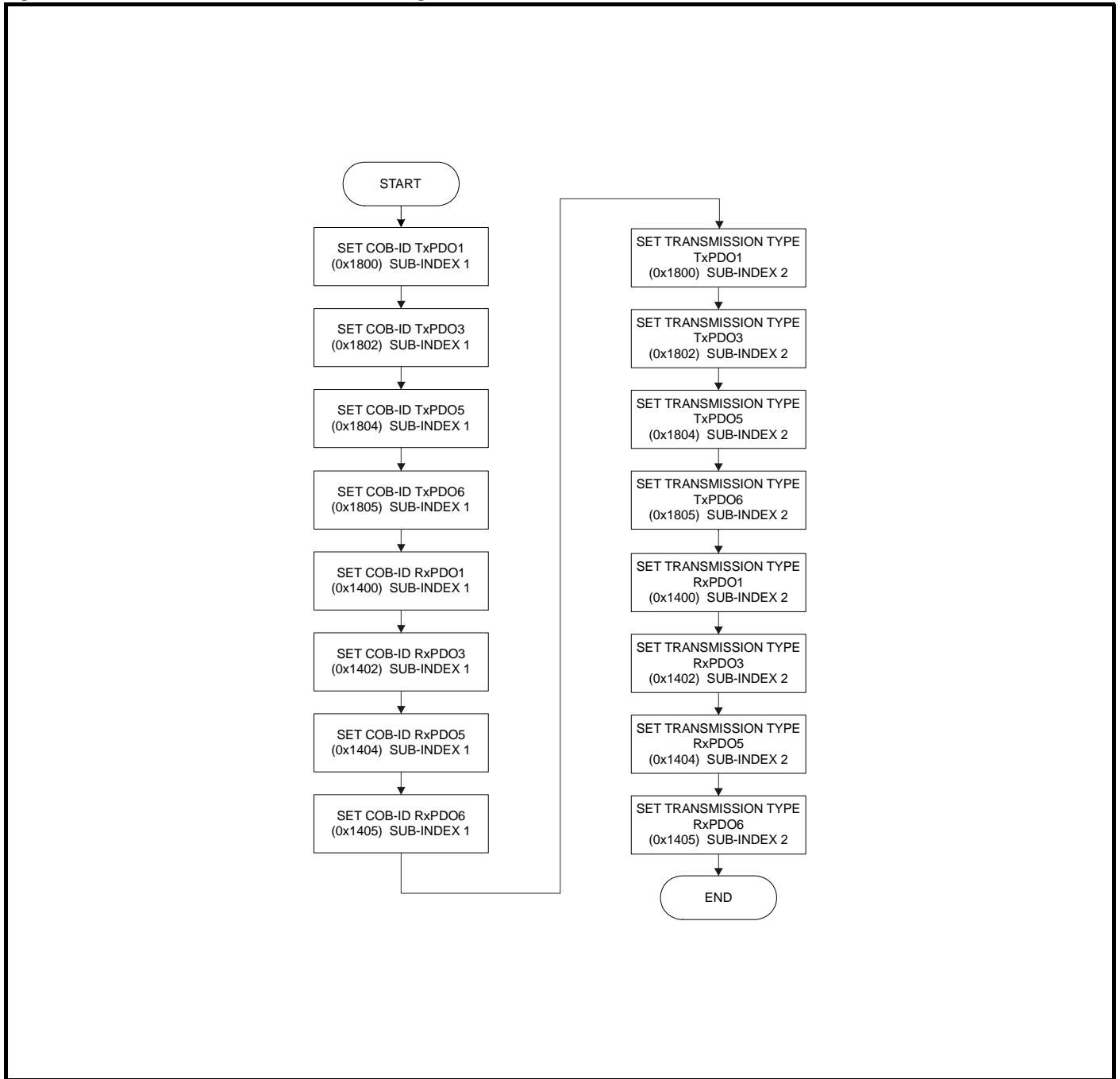

NOTE This chart is used in conjunction with Figure 5-3 *Configuration options flowchart* on page 22.

5.9.5 Mapping Configuration of PDOs

Figure 5-6 shows the configuration of the mappings for PDOs. This is performed using the SDOs shown below. The route through this flowchart will be determined by the size of the parameters that are mapped.

Figure 5-6 Mapping Configuration Flowchart [1]

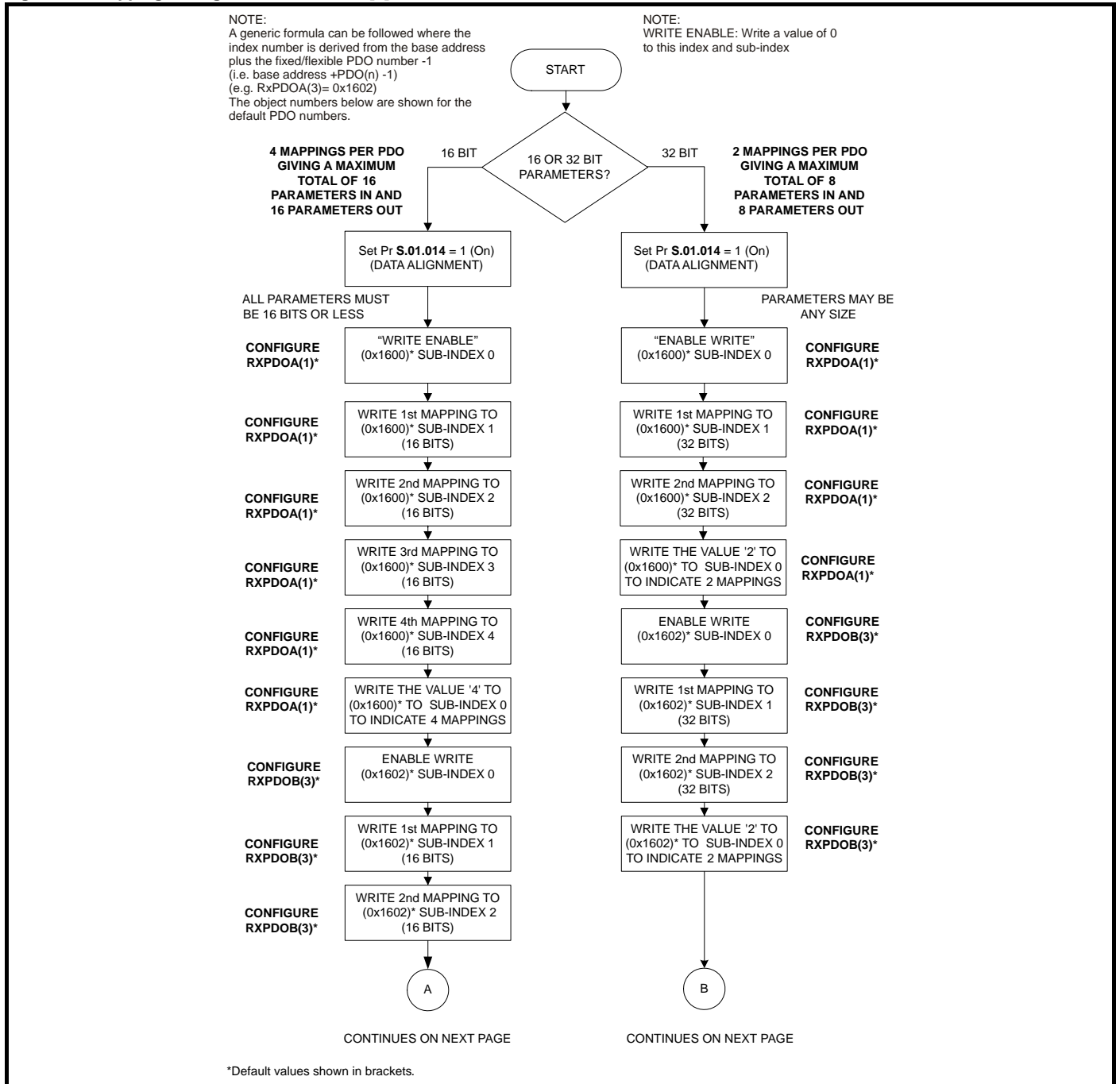

NOTE This chart is used in conjunction with Figure 5-3 *Configuration options flowchart* on page 22. Setting Pr **S.01.014** to 1 (data alignment on) will allow a maximum of four mappings. If data compression is off, or the parameters are 32 bits, then only two mappings will be possible (i.e. each PDO has 64 bits, so the size of the parameters mapped will determine the maximum number of mappings). PDOs A, B, C & D may be configured to any valid PDO number and the TxPDO and RxPDO numbers are independent. The default configuration for PDOA, B, C & D are PDO numbers 1, 3, 5 & 6 respectively.

Figure 5-7 Mapping Configuration Flowchart [2]

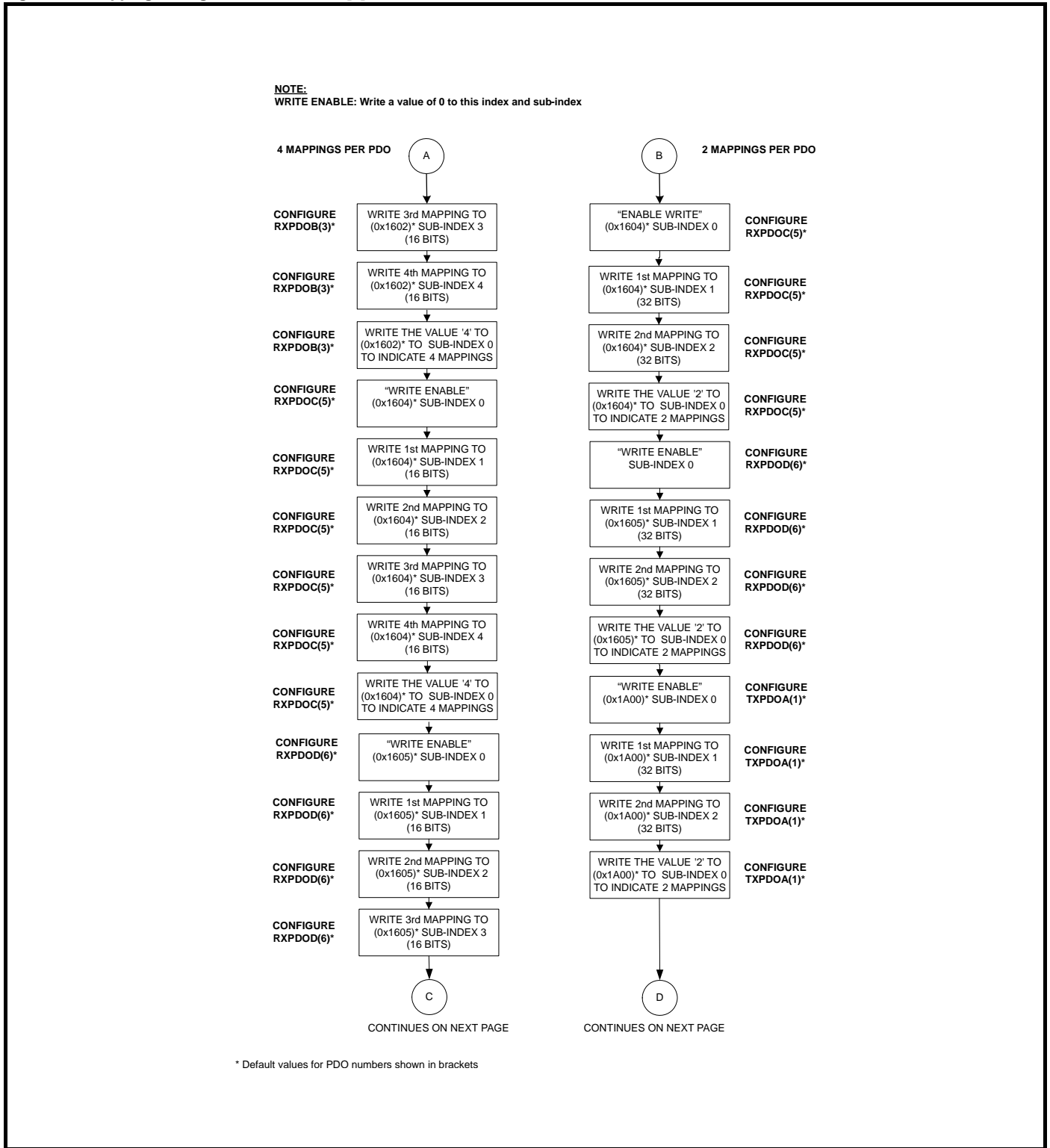

NOTE This chart is used in conjunction with Figure 5-3 *Configuration options flowchart* on page 22. PDOs A, B, C & D may be configured to any valid PDO number, TxPDO and RxPDO numbers are independent. The default configuration for PDOA, B, C & D are PDO numbers 1, 3, 5 and 6 respectively, the default configuration uses the same numbers for both TxPDOs and RxPDOs, although this is not a requirement.

Figure 5-8 Mapping Configuration Flowchart [3]

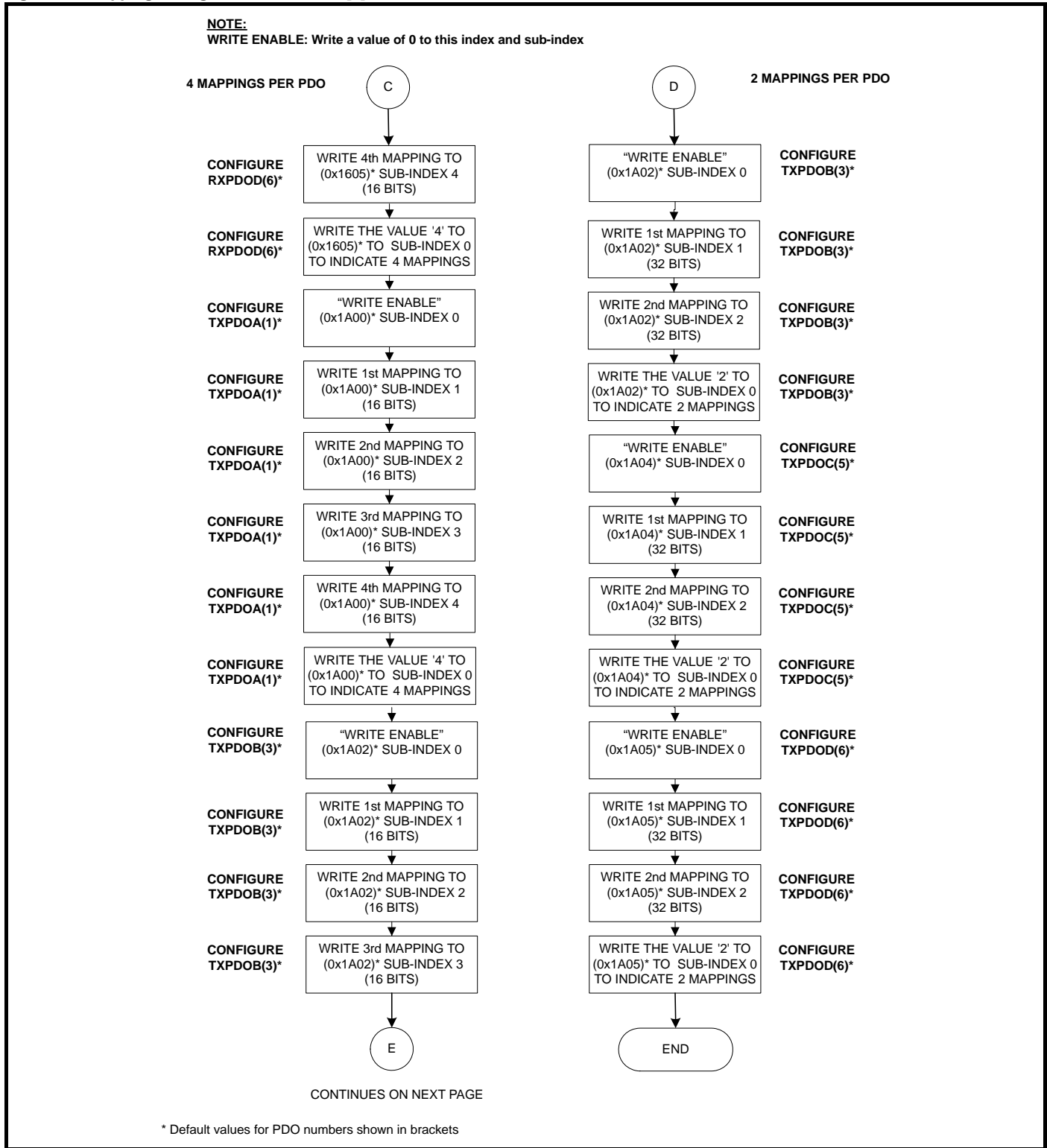

NOTE Return to Figure 5-3 *Configuration options flowchart* on page 22.
 PDOs A, B, C & D may be configured to any valid PDO number, TxPDO and RxPDO numbers are independent. The default configuration for PDO A, B, C & D are PDO numbers 1, 3, 5 & 6 respectively. The default configuration uses the same numbers for both TxPDOs and RxPDOs, although this is not a requirement.

Figure 5-9 Mapping Configuration Flowchart [4]

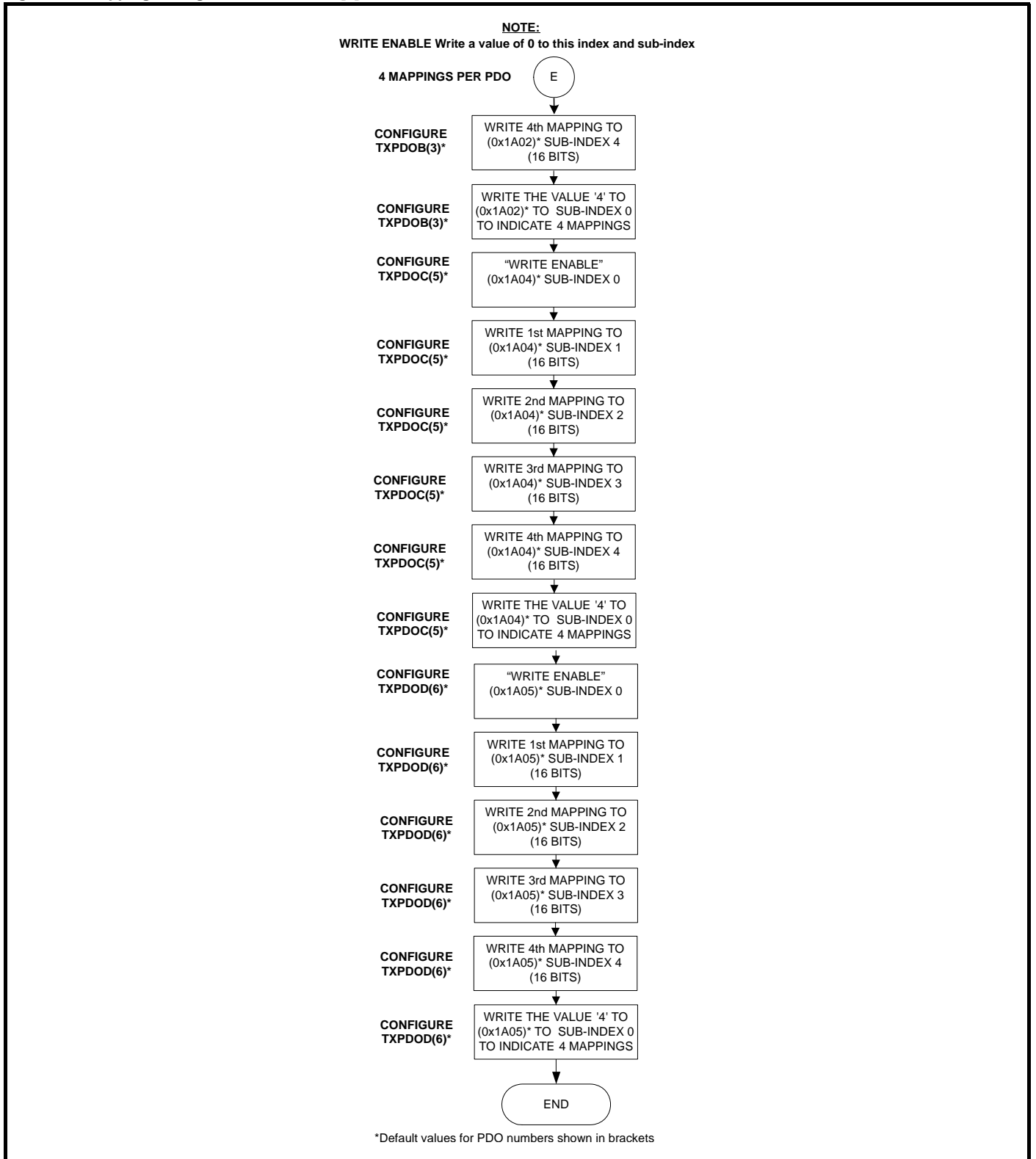

NOTE Return to Figure 5-3 *Configuration options flowchart* on page 22. PDOs A, B, C & D may be configured to any valid PDO number, TxPDO and RxPDO numbers are independent. The default configuration for PDO A, B, C & D are PDO numbers 1, 3, 5 & 6 respectively. The default configuration uses the same numbers for both TxPDOs and RxPDOs, although this is not a requirement.

5.9.6 Flexible PDO configuration

Figure 5-10 details the stages required to configure SI-CANopen to use custom PDO numbering (any valid PDO number from 1 to 511 may be configured). The required PDO numbers for TxPDO A, B, C & D and RxPDO A, B, C & D are written to the configuration objects shown below (the actual value written is the PDO number minus 1).

Figure 5-10 SDO Configuration

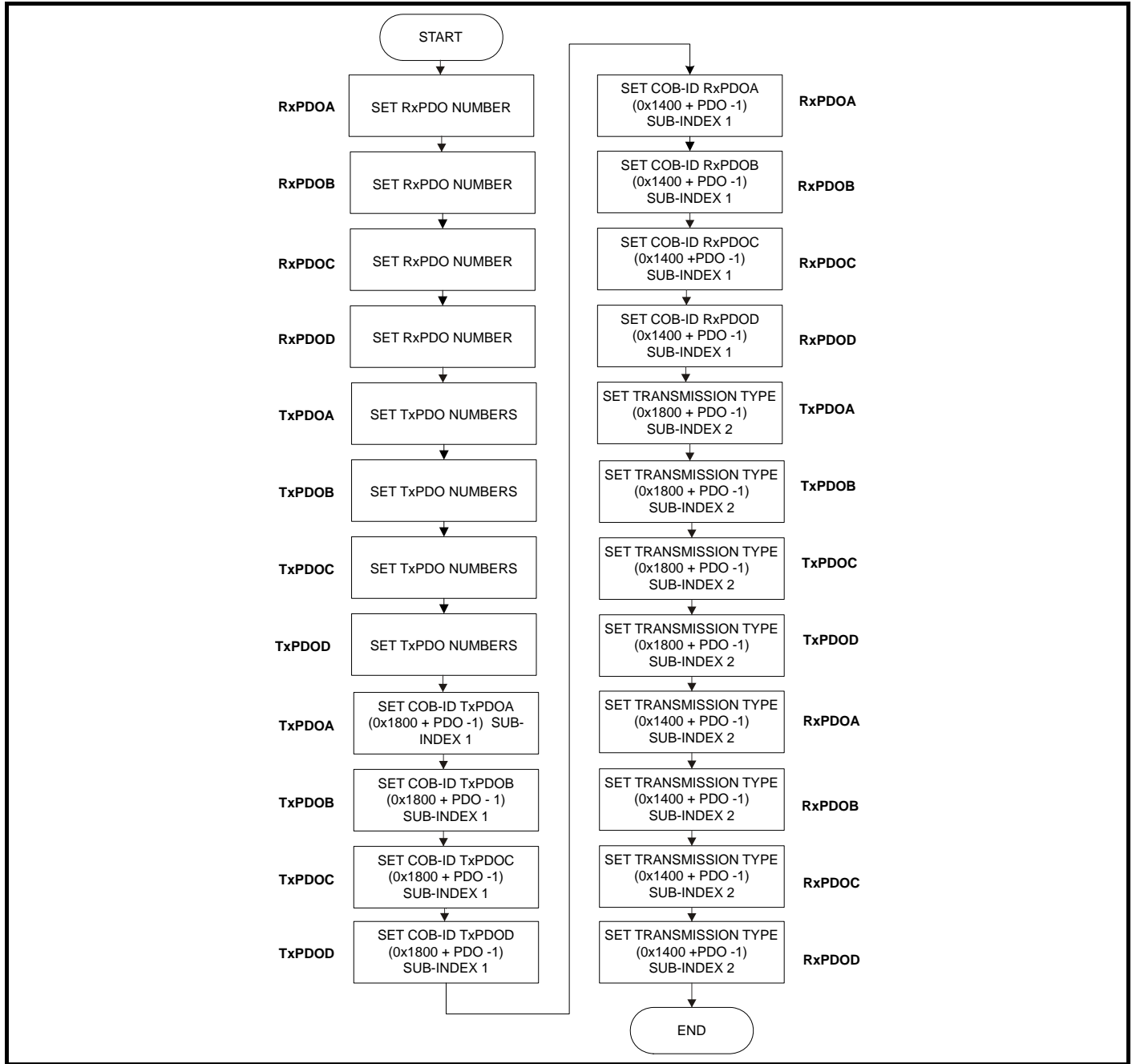

NOTE This chart is used in conjunction with Figure 5-3 Configuration options flowchart on page 22.

The object references in Figure 5-10 (e.g. object 0x1400) are the base addresses for the communication objects. The actual object must be calculated by adding the PDO number configured for PDO (A, B, C or D) to the base address and then subtracting 1.

For example to set TxPDOA to PDO number 3, Sub-index 1 of object 0x2801 should be set to 2. To set the COB ID for TxPDO 3, object 0x1802 sub-index 1 should be written to. This example configuration sets TxPDOA to TxPDO 3, then configures the transmission type using the SDO configuration for TxPDO3 (i.e. the TxPDO is configured as normal).

5.9.7 Saving SDO setup in SI-CANopen

Figure 5-11 details the procedure to save previously sent SDO configuration settings to the SI-CANopen internal memory. This removes the requirement to re-send configuration SDOs if the SI-CANopen is reset or powered down.

Figure 5-11 Saving SDO setup

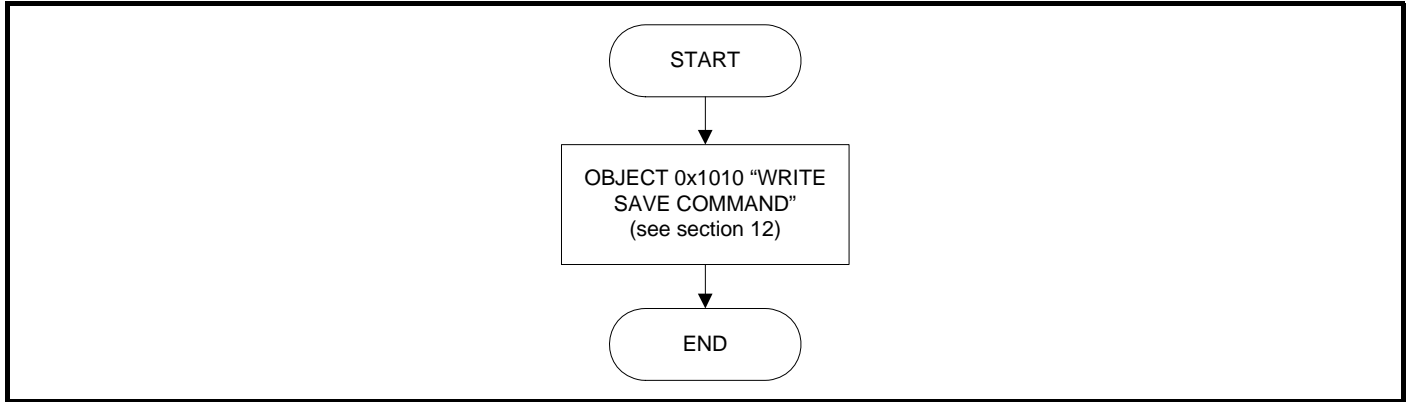

Configuration may also be set in user programs. See section on page 87 for more information.

5.9.8 Controllers/PLC with no SDO configuration facility or fixed PDOs

Controllers/PLCs do not support SDO configuration of communication objects or may only support fixed PDO numbers. In this case it may be possible to use an alternative controller/PLC to configure the module, and perform a save (using object 0x1010) see section 11.3.8 *Store parameters* on page 65 for more information. This allows pre-configured SI-CANopen models to be shipped to site after previously being configured.

6 Parameters

6.1 Menus

The table below details each of the module's internal menus.

Menu	Description
S.0	Module information
S.1	SI-CANopen Setup
S.2	PDOA Setup
S.3	PDOB Setup
S.4	PDOC Setup
S.5	PDOD Setup
S.6	RPDO Fault values
S.9	Resources

S is the slot number where the module is installed.

The module's menu 0 is also displayed in menu 15, 16 or 17 depending on which slot the module is installed in. The table below shows the location of the module's menu 0 on the drive.

Slot Number	Menu 0 location
1	15
2	16
3	17

6.2 Menu 0 - Module Set-up

All parameters in **S.00.ppp** (i.e. menu 0 within the option module menus) are also present in menus 15, 16 or 17 depending on the slot that the module is installed to e.g. Pr **3.00.007** is also present as 17.007.

The functionality and properties of the parameters are identical between the two menus.

S.00.001		Module ID	
Minimum	0	Maximum	65535
Default	448	Units	
Type	16 Bit Volatile	Update Rate	Power-up write
Display Format	None	Decimal Places	0
Coding	RO, ND, NC, PT, BU		

Pr **S.00.001** displays the ID number for the Option Module. For SI-CANopen, this is 448.

S.00.002		Firmware version	
Minimum	0 (Display 00.00.00.00)	Maximum	99999999 (Display 99.99.99.99)
Default		Units	
Type	32 Bit Volatile	Update Rate	Power-up write
Display Format	Version Number	Decimal Places	0
Coding	RO, ND, NC, PT		

The firmware version of the option module is in the format of **ww.xx.yy.zz**.

S.00.003		Hardware version	
Minimum	00.00	Maximum	99.99
Default		Units	
Type	16 Bit Volatile	Update Rate	Power-up write
Display Format	None	Decimal Places	2
Coding	RO, ND, NC, PT		

The hardware version of the option module is in the format of **xx.yy**.

S.00.004	Serial Number LS		
S.00.005	Serial Number MS		
Minimum	0	Maximum	99999999
Default		Units	
Type	32 Bit Volatile	Update Rate	Power-up write
Display Format	None	Decimal Places	0
Coding	RO, ND, NC, PT		

The module serial number is available as a pair of 32-bit values where Serial Number LS (Pr **S.00.004**) provide the least significant 8 decimal digits, and Serial Number MS (Pr **S.00.005**) provides the most significant 8 decimal digits. The reconstructed serial number is $((\mathbf{S.00.005} \times 10000000) + \mathbf{S.00.004})$. For example serial number "0001234567898765" would be stored as **S.00.005** = 123456 and **S.00.004** = 67898765.

S.00.006	Module Status		
Minimum	0	Maximum	101
Default		Units	
Type	8 Bit Volatile	Update Rate	Background read
Display Format	None	Decimal Places	0
Coding	RO, TE, ND, NC, PT		

This parameter displays the current status of the module. All possible values are shown in the table below.

Value	Text	Description
-2	Bootldr-Update	The bootloader is performing a flash update.
-1	Bootldr-Idle	The bootloader is idle.
0	Initializing	Module is currently initializing.
1	Ok	Module has initialized and has found no errors.
2	Config	A configuration error has been detected in one of the communications protocols or user program.
3	Error	An error has occurred preventing the firmware or user program from running correctly.

S.00.007	Reset Module		
Minimum	0	Maximum	1
Default	0	Units	
Type	1 Bit Volatile	Update Rate	Read every 200 ms
Display Format	None	Decimal Places	0
Coding	RW, NC		

Changes to the module's configuration will not take effect until the module has been reset.

- To reset the module:
- Set Pr **S.00.007** to On (1).
- When the sequence has been completed, Pr **S.00.007** will be reset to Off (0).

The module will reset using the updated configuration.

NOTE

This sequence does NOT store the module's configuration parameters in the drive or the module's flash memory. This parameter will change back to Off immediately, and as such the change may not be visible in the display.

S.00.008	Default Module		
Minimum	0	Maximum	1
Default	0	Units	
Type	1 Bit Volatile	Update Rate	Read every 200 ms
Display Format	None	Decimal Places	0
Coding	RW, NC		

If the host drive is defaulted (see the drive *User Guide* for details), it will also clear the current configuration for the slot the module is installed to.

This can be performed as follows:

- Set Pr **S.00.008** to On.
- Reset the module by setting Pr **S.00.007** to On.
- Default parameter values for the module will be loaded.

The module will reset using the default values.

6.3 Menu 1 - SI-CANopen Setup

Menu 1 contains all the parameters relating to the setup of the SI-CANopen interface on the SI-CANopen module.

S.01.001		Enable SI-CANopen Interface	
Minimum	0	Maximum	1
Default	1	Units	
Type	1 Bit Volatile	Update Rate	Read every 200 ms
Display Format	None	Decimal Places	0
Coding	RO, NC		

S.01.002		Reset SI-CANopen Interface	
Minimum	0	Maximum	1
Default	0	Units	
Type	1 Bit Volatile	Update Rate	Read every 200 ms
Display Format	None	Decimal Places	0
Coding	RW, NC		

Changes to the module's configuration will not take effect until the module has been reset.

To reset the module:

- Set Pr **S.01.002** to On (1).
- When the sequence has been completed, Pr **S.01.002** will be reset to Off (0).
- The module will reset using the updated configuration.

NOTE

This sequence does NOT store the module's configuration parameters in the drive or the module's flash memory. This parameter will change back to Off immediately, and as such the change may not be visible in the display.

S.01.003		Default SI-CANopen Interface	
Minimum	0	Maximum	1
Default	0	Units	
Type	1 Bit Volatile	Update Rate	Read every 200 ms
Display Format	None	Decimal Places	0
Coding	RW, NC		

If the host drive is defaulted (see the drive user guide for details), it will also clear the current configuration for the slot the module is installed to.

This can be performed as follows:

- Set Pr **S.01.003** to On.
- Reset the module by setting Pr **S.01.002** to On.
- Default parameter values for the module will be loaded.

The module will reset using the default values.

S.01.004		SI-CANopen Node Address	
Minimum	0	Maximum	127
Default	0	Units	
Type	8 Bit User Save	Update Rate	Module reset / initialization
Display Format	None	Decimal Places	0
Coding	RW, BU		

Every node on a SI-CANopen network must be given a unique network node address. To activate a change in the node address value, the module must be reset (Pr **S.01.002** or **MM.007** = On).

Note: If an invalid address is set, the module will over-write the value in Pr **S.01.004** with 0. When the module is reset, this value will be used as the node address. A node address of 0 will disable the SI-CANopen communications layer but the DSP305 V1.1 Layer Setting Service (LSS) will still be active.

S.01.005		Baud Rate	
Minimum	0	Maximum	6
Default	2	Units	
Type	8 Bit User Save	Update Rate	Module reset / initialization
Display Format	None	Decimal Places	0
Coding	RW, PR, TE, NC, PT		

Every node on a CANopen network must be configured to run at the same network data rate. If a node is configured with the wrong data rate, it may cause errors on the CANopen network. The module must be reset to make a change of data rate take effect (**S.01.002** or MM.007 = On).

Value	Baud Rate
0	1 Mb s
1	800 kb s
2	500 kb s
3	250 kb s
4	125 kb s
5	50 kb s
6	Auto detect

CANopen may be configured to automatically detect the network data rate by setting Pr **S.01.005** to "Auto detect" (6). SI-CANopen will monitor the CANopen network, and if the data rate is detected, it will set Pr **S.01.005** to indicate the detected data rate. However, it should be noted that the new value of Pr **S.01.005** will NOT be stored.

The recommended sequence of events using auto-detection of the data rate as follows:

1. Power up the drive.
2. Set Pr **S.01.005** to "Auto detect" (6).
3. Reset the module by setting Pr **MM.007** to On.
4. Connect the module to the SI-CANopen network.
5. Wait for Pr **S.01.006** to change from "Baud detecting".
6. Store the parameters by performing a drive save (Pr **mm.000** to "Save parameters").

NOTE

SI-CANopen will not be able to reliably detect the network data rate if there is little or no traffic on the network. Auto detection of the data rate is ideal when connecting a new node to an existing network, but may not work reliably if a network is powered up with all nodes attempting to detect the data rate.

S.01.006		CANopen Network Diagnostic	
Minimum	0	Maximum	8
Default		Units	
Type	8 Bit Volatile	Update Rate	Background
Display Format	None	Decimal Places	0
Coding	RO, TE, ND, NC, PT, BU		

S.01.007		Cyclic Data Rate	
Minimum	0	Maximum	9999
Default		Units	Messages/s
Type	16 Bit Volatile	Update Rate	Background
Display Format	None	Decimal Places	0
Coding	RO, ND, NC, PT, BU		

The CANopen network activity can be monitored using the CANopen Network Diagnostic parameter, Pr **S.01.006**. All possible values of Pr **S.01.006** are shown below.

Value	Text	Description
0	Network OK	Network healthy.
1	Internal HW Fail	Indicates that part of the SI-CANopen initialization sequence was not successful. If this fault persists after a power cycle, replace the SI-CANopen.
2	Init OK	Indicates that the SI-CANopen has initialized correctly, and is waiting for the SI-CANopen master to initialize communications.
3	Network No Data	Indicate that the CANopen master has established communications with SI-CANopen, but there is currently no data transfer in progress.
4	Config Error	Indicates that there is an invalid setting in the SI-CANopen configuration parameters. This could be due to a mapping error.
5	Software error	An internal software error has occurred. Reset the SI-CANopen to clear this error. If error persists, replace the SI-CANopen.
6	Baud detecting	Baud rate detection is in progress.
7	Device disabled	Indicates that the SI-CANopen communications layer has been disabled by setting the node address to 0.
8	Initialize delay	Initialization delayed, waiting for Applications module(s) to finish Initial task.

When the SI-CANopen is in data exchange with the CANopen master controller, Pr **S.01.007** will give an indication of the number of cyclic data messages that are being processed per second. The messages included in the count are as follows:

- Every Sync object on the network.
- Every Tx or Rx PDO handled.

S.01.008		PDO Configuration Source	
Minimum	0	Maximum	1
Default	0	Units	
Type	8 Bit User Save	Update Rate	Background
Display Format	None	Decimal Places	0
Coding	RW, TE		

Value	Text
0	By Menu
1	By Master

The function of this parameter is used to indicate the source used to configure PDO mapping. It is defaulted as "By Menu" (0), which means the PDO mapping is configured by the setup menu. Once any of the objects in the supported object dictionary are changed, the value of this parameter will be changed to "By Master" (1) by the module. This means the objects have been modified by the master/SDO.

When the module powers up, if the value of this parameter is seen as "By Master" (1), then the PDO mappings will all be cleared and the module will wait for the master to configure them.

S.01.010		Timeout Delay	
Minimum	0	Maximum	3000
Default	0	Units	ms
Type	16 Bit User Save	Update Rate	Module reset / initialization
Display Format	None	Decimal Places	0
Coding	RW, BU		

The module will reset an internal timer when a valid message (SYNC or RPDO message) is received from the CANopen network. The network loss trip is triggered when no new messages are received before the timer reaches the designated value.

S.01.011		Timeout Action	
Minimum	0	Maximum	4
Default	0	Units	
Type	8 Bit User Save	Update Rate	Module reset / initialization
Display Format	None	Decimal Places	0
Coding	RW, TE, BU		

Value	Text	Description
0	Trip	Trip the drive.
1	Send flt values	Send fault values to PLC output parameters.
2	Clear output	Set all PLC output parameters to zero.
3	Hold last	Hold the last values in the PLC output parameters.
4	No action	No action with PLC output parameters.

Pr **S.01.011** is used to determine the action to take when a CANopen timeout error occurs.

S.01.012		Timeout Event Destination	
Minimum	0	Maximum	4
Default	0	Units	
Type	8 Bit User Save	Update Rate	Module reset / initialization
Display Format	None	Decimal Places	0
Coding	RW, TE, BU		

Value	Text	Description
0	This slot	This slot
1	Slot 1	Slot 1
2	Slot 2	Slot 2
3	Slot 3	Slot 3
4	Slot 4	Slot 4

S.01.013		Timeout Event Type	
Minimum	0	Maximum	5
Default	0	Units	
Type	8 Bit User Save	Update Rate	Module reset / initialization
Display Format	None	Decimal Places	0
Coding	RW, TE, BU		

Value	Text	Description
0	No event	This slot
1	Event 0	Event 0
2	Event 1	Event 1
3	Event 2	Event 2
4	Event 3	Event 3
5	Event 4	Event 4

Pr **S.01.013** defines the event to trigger when a CANopen event occurs. Pr **S.01.012** must specify an appropriate consumer of the event.

S.01.014		Data Alignment	
Minimum	0	Maximum	1
Default	0	Units	
Type	8 Bit User Save	Update Rate	Module reset / initialization
Display Format	None	Decimal Places	0
Coding	RW, TE, BU		

Value	Text	Description
0	32	32 bits
1	16	16 bits

By default, SI-CANopen uses 32-bits for each data channel even if the target parameter in the drive is a 16-bit parameter. This strategy (known as "casting"), ensures that the cyclic data transmitted over the network is kept aligned with memory locations in 32-bit PLCs. The following table shows the actual sizes of the mapped data with different data alignment.

Parameter size (bits)	Actual data size (bits) Data Alignment = 16	Actual data size (bits) Data Alignment = 32
1	16	32
8		
16		
32	32	

S.01.020		DSP402 Enable	
Minimum	0	Maximum	1
Default	0	Units	
Type	1 Bit User Save	Update Rate	Module reset / initialization
Display Format	None	Decimal Places	0
Coding	RW		

Setting this parameter to Off (0) causes the SI-CANopen module to take the default configuration for PDO1 from the SI-CANopen PDOA menu, other PDOs will contain no mappings by default. It also disables the DSP402 profile state machine and access to profile objects.

Setting this parameter to On (1), ensures that all PDO's take the default configuration as defined in *DSP402 V2.0 section 7.3*. No manufacturer specific mappings will be used (avoid mixed use of DSP402 specific mappings and manufacturer specific mappings).

In both cases, the default mappings can be over-written by the user through the SDO protocol. Also, objects defined by the profile and re-implemented in a SI-Applications module can be accessed in both cases.

Users wishing to implement a new profile or profile mode, should implement the entire profile on the SI-Applications module and disable the built in profiles.

S.01.021		Compatibility Mode	
Minimum	0	Maximum	1
Default	0	Units	
Type	8 Bit User Save	Update Rate	Module reset / initialization
Display Format	None	Decimal Places	0
Coding	RW, TE, BU		

Value	Text
0	Unidrive M
1	Unidrive SP

Pr **S.01.021** can be used to alter the product code enabling the SI-CANopen module to appear as an SM-CANopen module as seen by the master controller.

S.01.022		Compatibility Mode Software Revision	
Minimum	00.00.00.00	Maximum	99.99.99.99
Default	00.00.00.00	Units	
Type	32 bit user save	Update Rate	Module reset / initialization
Display Format	Version Number	Decimal Places	
Coding	RW, BU		

S.01.023		Compatibility Mode Serial Number	
Minimum	0	Maximum	999999999
Default	0	Units	
Type	32 bit user save	Update Rate	Module reset / initialization
Display Format	None	Decimal Places	
Coding	RW, BU		

When the compatibility mode parameter (Pr **S.01.021**) is set to "Unidrive SP" (1), the Compatibility Mode Software Revision parameter (Pr **S.01.022**) is used to set the version of firmware that was on the SM-CANopen module that is being replaced. Also, the Compatibility Mode Serial Number parameter (Pr **S.01.023**), is used to set the serial number of the SM-CANopen module that is being replaced.

Setting these parameters will allow compatibility using previous CANopen master projects that utilised SM-CANopen modules.

6.4 Menu 2 - PDOA Setup

Menu 2 contains all the parameters relating the setup of PDOA.

S.02.001	TPDOA Length		
S.02.002	RPDOA Length		
Minimum	0	Maximum	4
Default	4	Units	
Type	8 Bit Volatile	Update Rate	Module reset / initialization
Display Format	None	Decimal Places	0
Coding	RW, NC		

Parameters **S.02.001** and **S.02.002** define the length of TPDOA and RPDOA respectively.

They are monitored in the background by the SI-CANopen module. Attempts by the user to exceed the defined range will cause the module to reset the parameter value displayed to the relevant minimum or maximum.

S.02.003	TPDOA Transmission Type		
Minimum	0	Maximum	255
Default	255	Units	
Type	8 Bit Volatile	Update Rate	Module reset / initialization
Display Format	None	Decimal Places	0
Coding	RW, BU		

Pr **S.02.003** sets the current transmission type of TPDOA. Because all PDO's are handled in the same way, if the master changes this setting through the PDO configuration object, the parameter will not be updated.

Transmission type	Cyclic	Acyclic	Synchronous	Asynchronous	RTR only
0		X	X		
1 – 240	X		X		
241 – 251	Reserved	Reserved	Reserved	Reserved	Reserved
252			X		X
253				X	X
254				X	
255				X	

- Type 0 transmits after a sync message, only when data has changed.
- Types 1 to 240 transmit every n sync messages.
- (*Types 241 to 251 are reserved and will therefore produce an error if selected*). See Pr **S.02.004**.
- Type 252 transmits only on remote request, data is updated on receipt of the sync message.
- Type 253 data updated and transmits only on remote request.
- Type 254 transmits when the TPDO-n event trigger parameter is set to on.
- Type 255 transmits on profile specific event.

The manufacturer specific (254) and profile specific even type (255) will be implemented to transmit the PDO every n ms where n is specified by sub-index 5 of the PDO communication parameter. This value will default to 0, which disables the transmission.

S.02.004	TPDOA Mapping Status		
S.02.005	RPDOA Mapping Status		
Minimum	0	Maximum	8
Default	0	Units	
Type	8 Bit Volatile	Update Rate	Background
Display Format	None	Decimal Places	0
Coding	RO, TE, NC, PT, BU		

The module will scan and check the SI-CANopen mapping parameter configuration for errors during initialization. If an error is detected, the CANopen Network Diagnostic parameter (Pr **S.01.006**) will indicate "Config Error" (4) and the mapping error detected will be indicated in the relevant parameter.

The table below shows all possible values for Prs **S.02.004** and **S.02.005**.

Value	Text	Description
0	Mapping OK	No error detected with cyclic data mapping configuration.
1	Too Many Maps	Too many cyclic data channels configured.
2	No Mapping	Cyclic data length is 0 or there are no mappings.
3	Read Mismatch	The parameter may not exist.
4	Hole In Mapping	The cyclic data mapping parameters are not contiguous.
5	Duplicate Map	Two or more cyclic data mapping configuration parameters have been configured with the same destination.
6	Length Mismatch	The data length doesn't match.
7	DSP402 Align	Data alignment must be set to 16 bits to allow the DSP 402 device profiles to be used.
8	Trans Type	The transmission type selected is not supported.

S.02.006	TPDOA Processing Time		
S.02.007	RPDOA Processing Time		
Minimum	0	Maximum	65535
Default	0	Units	ms
Type	16 Bit Volatile	Update Rate	Background
Display Format	None	Decimal Places	0
Coding	RO, ND, NC, PT, BU		

Pr **S.02.006** displays the time between receiving the output value from the drive and being sent successfully to the master.

Pr **S.02.007** displays the time between receiving the input value from the master and being sent successfully to the drive.

S.02.008	PDOA Input Consistency Enable		
S.02.010	PDOA Output Consistency Enable		
Minimum	0	Maximum	1
Default	0	Units	
Type	1 Bit User Save	Update Rate	Module reset / initialization
Display Format	None	Decimal Places	0
Coding	RW		

S.02.009	PDOA Input Consistency Trigger Parameter		
S.02.011	PDOA Output Consistency Trigger Parameter		
Minimum	0.00.000	Maximum	5.99.999
Default	0.00.000	Units	
Type	32 Bit User Save	Update Rate	Module reset / initialization
Display Format	Slot Menu Parameter	Decimal Places	0
Coding	RW, BU		

The SI-CANopen module provides an input/output consistency feature which ensures that the data in the input or output mappings is only transferred between the SI-CANopen module and the master when the mapped parameters are ready. This prevents data skew between parameters in the input/output mappings.

If PDOA Input Consistency Enable (Pr **S.02.008**) and PDOA Output Consistency Enable (Pr **S.02.010**) are set to 0 (i.e. default settings), then the input/output consistency features are disabled in order that input and output data is always read from or written to the master/ module.

If PDOA Input Consistency Enable (Pr **S.02.008**) is set to On (1), the SI-CANopen module will check the value of the parameter specified by the PDOA Input Consistency Trigger Parameter (Pr **S.02.009**). If the PDOA Input Trigger Parameter defined by Pr **S.02.009** is set to a non-zero value (for example by a user program in an applications module), this indicates to the SI-CANopen module that all the mapped parameters are ready to be read. The module will then read the mapped parameters, transfer them to the master, and then clear the input trigger source parameter to zero. When the input trigger source parameter is set to zero, the SI-CANopen module will continue to transfer the previously read data to the master.

If PDOA Output Consistency Enable (Pr **S.02.010**) is set to On (1), the SI-CANopen module will check the value of the parameter specified by the PDOA Output Consistency Trigger Parameter (Pr **S.02.011**). The PDOA Output Trigger Parameter defined by Pr **S.02.011** will initially be set to 1.

If the output trigger source parameter is set to zero (for example by a user program in an applications module), this indicates to the SI-CANopen module that all the mapped parameters are ready to be written to. The module will then write the data from the master into the mapped parameters, and will then set the output trigger source parameter to 1. When the output trigger source parameter is set to 1, it indicates to the SI-CANopen module that the mapped parameters are not ready to be written to, and therefore any new data from the master will not be written to the mapped parameters in the drive until the output trigger source parameter is again set to zero.

S.02.012		PDOA Event Trigger	
Minimum	0	Maximum	1
Default	0	Units	
Type	1 Bit User Save	Update Rate	Module reset / initialization
Display Format	None	Decimal Places	0
Coding	RW		

When the transmission type (Pr **S.02.003**) is set to 254 (Manufacturer specific event), setting this parameter to On (1) triggers any PDOs configured to be transmitted or received PDOs acted upon. Once triggered, the module will reset the parameter to Off (0).

S.02.013		TPDOA Number	
S.02.014		RPDOA Number	
Minimum	0	Maximum	512
Default	1	Units	
Type	16 Bit User Save	Update Rate	Module reset / initialization
Display Format	None	Decimal Places	0
Coding	RW, BU		

There are four TPDOs and four RPDOs available in the SI-CANopen. These PDOs are referred to as PDOs A, B, C and D. Each of these PDOs can be configured to be any of the 512 available PDOs. By default the configuration will be PDOA = 1, PDOB = 3, PDOC = 5 and PDOD = 6 (for both TPDOs and RPDOs).

If a configuration using non-default or flexible numbering is required, the index number for the PDO communication objects must be derived by subtracting 1 from the PDO number and adding this number to the base address. E.g. for 0x1600 PDO3 = 0x1602 (mapping information for RPDOs).

S.02.015		TPDOA Mapping Parameter 1	
S.02.016		TPDOA Mapping Parameter 2	
S.02.017		TPDOA Mapping Parameter 3	
S.02.018		TPDOA Mapping Parameter 4	
S.02.019		RPDOA Mapping Parameter 1	
S.02.020		RPDOA Mapping Parameter 2	
S.02.021		RPDOA Mapping Parameter 3	
S.02.022		RPDOA Mapping Parameter 4	
Minimum	0.00.000	Maximum	5.99.999
Default	See below	Units	
Type	32 Bit User Save	Update Rate	Module reset / initialization
Display Format	Slot Menu Param	Decimal Places	0
Coding	RW, BU		

Parameters **S.02.015** - **S.02.018** are used to define the application objects which are mapped to TPDOA.

Parameters **S.02.019** - **S.02.022** are used to define the application objects which are mapped to RPDOA.

Entering a value indicating that slot 5 is used will utilise the SI-CANopen module's parameter in the local slot allowing modules to be able to be moved in different slots. For example, 5.01.006 will use the CANopen Network Diagnostic parameter for the SI-CANopen module in the local slot.

The defaults of all the mapping parameters are as follows:

Parameter	Default	Description
TPDOA Mapping Parameter 1 (Pr S.02.015)	0.10.040	Status Word
TPDOA Mapping Parameter 2 (Pr S.02.016)	0.02.001	Post Ramp Reference
TPDOA Mapping Parameter 3 (Pr S.02.017)	0.00.000	Not used
TPDOA Mapping Parameter 4 (Pr S.02.018)	0.00.000	Not used
RPDOA Mapping Parameter 1 (Pr S.02.019)	0.06.042	Control Word
RPDOA Mapping Parameter 2 (Pr S.02.020)	0.01.021	Preset Reference 1
RPDOA Mapping Parameter 3 (Pr S.02.021)	0.00.000	Not used
RPDOA Mapping Parameter 4 (Pr S.02.022)	0.00.000	Not used

6.5 Menu 3 - PDOB Setup

Menu 3 contains all the parameters relating to the PDOB setup.

S.03.001	TPDOB Length		
S.03.002	RPDOB Length		
Minimum	0	Maximum	4
Default	0	Units	
Type	8 Bit Volatile	Update Rate	Module reset / initialization
Display Format	None	Decimal Places	0
Coding	RW, NC		

Parameters **S.03.001** and **S.03.002** define the length of TPDOB and RPDOB respectively.

They are monitored in the background by the CANopen module. Attempts by the user to exceed the defined range will cause the module to reset the parameter value displayed to the relevant minimum or maximum.

S.03.003	TPDOB Transmission Type		
Minimum	0	Maximum	255
Default	255	Units	
Type	8 Bit Volatile	Update Rate	Module reset / initialization
Display Format	None	Decimal Places	0
Coding	RW, BU		

Pr **S.03.003** sets the current transmission type of TPDOB. As all PDOs are handled in the same way if the master changes this setting through the PDO configuration object the parameter will not be updated.

Transmission type	Cyclic	Acyclic	Synchronous	Asynchronous	RTR only
0		X	X		
1 – 240	X		X		
241 – 251	Reserved	Reserved	Reserved	Reserved	Reserved
252			X		X
253				X	X
254				X	
255				X	

- Type 0 transmits after a sync message, only when data has changed.
- Types 1 to 240 transmit every n sync messages.
- (Types 241 to 251 are reserved and will therefore produce an error if selected. See Pr **S.03.004**).
- Type 252 transmits only on remote request, data is updated on receipt of the sync message.
- Type 253 data updated and transmits only on remote request.
- Type 254 transmits when the TPDO- n event trigger parameter is set to on.
- Type 255 transmits on profile specific event.
- The manufacturer specific (254) and profile specific even type (255) will be implemented to transmit the PDO every n ms where n is specified by sub-index 5 of the PDO communication parameter. This value will default to 0, which disables the transmission.

S.03.004	TPDOB Mapping Status		
S.03.005	RPDOB Mapping Status		
Minimum	0	Maximum	8
Default	0	Units	
Type	8 Bit Volatile	Update Rate	Background
Display Format	None	Decimal Places	0
Coding	RO, TE, NC, PT, BU		

The module will scan and check the CANopen mapping parameter configuration for errors during initialization. If an error is detected, the CANopen Network Diagnostic parameter (Pr **S.01.006**) will indicate "Config Error" (4) and the mapping error detected will be indicated in the relevant parameter.

The table below shows all possible values for Prs **S.03.004** and **S.03.005**.

Value	Text	Description
0	Mapping OK	No error detected with cyclic data mapping configuration.
1	Too Many Maps	Too many cyclic data channels configured.
2	No Mapping	Cyclic data length is 0 or there are no mappings.
3	Read Mismatch	The parameter may not exist.
4	Hole In Mapping	The cyclic data mapping parameters are not contiguous.
5	Duplicate Map	Two or more cyclic data mapping configuration parameters have been configured with the same destination.
6	Length Mismatch	The length of data doesn't match.
7	DSP402 Align	Data alignment must be set to 16 bits to allow the DSP 402 device profiles to be used.
8	Trans Type	The transmission type selected is not supported.

S.03.006	TPDOB Processing Time		
S.03.007	RPDOB Processing Time		
Minimum	0	Maximum	65535
Default	0	Units	ms
Type	16 Bit Volatile	Update Rate	Background
Display Format	None	Decimal Places	0
Coding	RO, ND, NC, PT, BU		

Pr **S.03.006** displays the time between receiving the output value from the drive and being sent successfully to the master.

Pr **S.03.007** displays the time between receiving the input value from the master and being sent successfully to the drive.

S.03.008	PDOB Input Consistency Enable		
S.03.010	PDOB Output Consistency Enable		
Minimum	0	Maximum	1
Default	0	Units	
Type	1 Bit User Save	Update Rate	Module reset / initialization
Display Format	None	Decimal Places	0
Coding	RW		

S.03.009	PDOB Input Consistency Trigger Parameter		
S.03.011	PDOB Output Consistency Trigger Parameter		
Minimum	0.00.000	Maximum	5.99.999
Default	0.00.000	Units	
Type	32 Bit User Save	Update Rate	Module reset / initialization
Display Format	Slot Menu Parameter	Decimal Places	0
Coding	RW, BU		

The SI-CANopen module provides an input/output consistency feature which ensures that the data in the input or output mappings is only transferred between the SI-CANopen module and the master when the mapped parameters are ready. This prevents data skew between parameters in the input/output mappings.

If PDOB Input Consistency Enable (Pr **S.03.008**) and PDOB Output Consistency Enable (Pr **S.03.010**) are set to 0 (i.e. default settings), then the input/output consistency features are disabled so that input and output data is always read from or written to the master/ module.

If PDOB Input Consistency Enable (Pr **S.03.008**) is set to On (1), the SI-CANopen module will check the value of the parameter specified by the PDOB Input Consistency Trigger Parameter (Pr **S.03.009**). If the PDOB Input Trigger Parameter defined by Pr **S.03.009** is set to a non-zero value (for example by a user program in an applications module), this indicates to the SI-CANopen module that all the mapped parameters are ready to be read. The module will then read the mapped parameters, transfer them to the master and will then clear the input trigger source parameter to zero. When the input trigger source parameter is set to zero, the SI-CANopen module will continue to transfer the previously read data to the master.

If PDOB Output Consistency Enable (Pr **S.03.010**) is set to On (1), the SI-CANopen module will check the value of the parameter specified by the PDOB Output Consistency Trigger Parameter (Pr **S.03.011**). The PDOB Output Trigger Parameter defined by Pr **S.03.011** will initially be set to 1.

If the output trigger source parameter is set to zero (for example by a user program in an applications module), this indicates to the SI-CANopen module that all the mapped parameters are ready to be written to. The module will then write the data from the master into the mapped parameters, and will then set the output trigger source parameter to 1. When the output trigger source parameter is set to 1, it indicates to the SI-CANopen module that the mapped parameters are not ready to be written to, and therefore any new data from the master will not be written to the mapped parameters in the drive until the output trigger source parameter is again set to zero.

S.03.012	PDOB Event Trigger		
Minimum	0	Maximum	1
Default	0	Units	
Type	1 Bit User Save	Update Rate	Module reset / initialization
Display Format	None	Decimal Places	0
Coding	RW		

When the transmission type (Pr **S.03.003**) is set to 254 (Manufacturer specific event), setting this parameter to On (1) triggers any PDOs configured to be transmitted or received PDOs acted upon. Once triggered, the module will reset the parameter to Off (0).

S.03.013	TPDOB Number		
S.03.014	RPDOB Number		
Minimum	0	Maximum	512
Default	3	Units	
Type	16 Bit User Save	Update Rate	Module reset / initialization
Display Format	None	Decimal Places	0
Coding	RW, BU		

There are four TPDOs and four RPDOs available in the SI-CANopen. These PDOs are referred to as PDOs A, B, C and D. Each of these PDOs can be configured to be any of the 512 available PDOs. By default the configuration will be PDOA = 1, PDOB = 3, PDOC = 5 and PDOD = 6 (for both TPDOs and RPDOs).

If a configuration using non-default or flexible numbering is required, the index number for the PDO communication objects must be derived by subtracting 1 from the PDO number and adding this number to the base address, e.g. for 0x1600 PDO3 = 0x1602 (mapping information for RPDOs).

S.03.015	TPDOB Mapping Parameter 1		
S.03.016	TPDOB Mapping Parameter 2		
S.03.017	TPDOB Mapping Parameter 3		
S.03.018	TPDOB Mapping Parameter 4		
S.03.019	RPDOB Mapping Parameter 1		
S.03.020	RPDOB Mapping Parameter 2		
S.03.021	RPDOB Mapping Parameter 3		
S.03.022	RPDOB Mapping Parameter 4		
Minimum	0.00.000	Maximum	5.99.999
Default	0.00.000	Units	
Type	32 Bit User Save	Update Rate	Module reset / initialization
Display Format	Slot Menu Param	Decimal Places	0
Coding	RW, BU		

Parameters **S.03.015** – **S.03.018** are used to define the application objects which are mapped to TPDOB.

Parameters **S.03.019** – **S.03.022** are used to define the application objects which are mapped to RPDOB.

Entering a value indicating that slot 5 is used will utilise the SI-CANopen module's parameter in the local slot allowing modules to be able to be moved in different slots. For example, 5.01.006 will use the CANopen Network Diagnostic parameter for the SI-CANopen module in the local slot.

6.6 Menu 4 – PDOC Setup

Menu 4 contains all the parameters relating to the setup of PDOC.

S.04.001	TPDOC Length		
S.04.002	RPDOC Length		
Minimum	0	Maximum	4
Default	0	Units	
Type	8 Bit Volatile	Update Rate	Module reset / initialization
Display Format	None	Decimal Places	0
Coding	RW, NC		

Parameters **S.04.001** and **S.04.002** define the length of TPDOC and RPDOC respectively.

They are monitored in the background by the CANopen module. Attempts by the user to exceed the defined range will cause the module to reset the parameter value displayed to the relevant minimum or maximum.

S.04.003	TPDOC Transmission Type		
Minimum	0	Maximum	255
Default	255	Units	
Type	8 Bit Volatile	Update Rate	Module reset / initialization
Display Format	None	Decimal Places	0
Coding	RW, BU		

Pr **S.04.003** sets the current transmission type of TPDOC. As all PDOs are handled in the same way if the master changes this setting through the PDO configuration object the parameter will not be updated.

Transmission type	Cyclic	Acyclic	Synchronous	Asynchronous	RTR only
0		X	X		
1 – 240	X		X		
241 – 251	Reserved	Reserved	Reserved	Reserved	Reserved
252			X		X
253				X	X
254				X	
255				X	

- Type 0 transmits after a sync message, only when data has changed.
- Types 1 to 240 transmit every n sync messages.
- (Types 241 to 251 are reserved and will therefore produce an error if selected. See Pr **S.04.004**.)
- Type 252 transmits only on remote request, data is updated on receipt of the sync message.
- Type 253 data updated and transmits only on remote request.
- Type 254 transmits when the TPDO- n event trigger parameter is set to on.
- Type 255 transmits on profile specific event.

The manufacturer specific (254) and profile specific even type (255) will be implemented to transmit the PDO every n ms where n is specified by sub-index 5 of the PDO communication parameter. This value will default to 0, which disables the transmission.

S.04.004	TPDOC Mapping Status		
S.04.005	RPDOC Mapping Status		
Minimum	0	Maximum	8
Default	0	Units	
Type	8 Bit Volatile	Update Rate	Background
Display Format	None	Decimal Places	0
Coding	RO, TE, NC, PT, BU		

The module will scan and check the CANopen mapping parameter configuration for errors during initialization. If an error is detected, the CANopen Network Diagnostic parameter (Pr **S.01.006**) will indicate "Config Error" (4) and the mapping error detected will be indicated in the relevant parameter.

The table below shows all possible values for Prs **S.04.004** and **S.04.005**.

Value	Text	Description
0	Mapping OK	No error detected with cyclic data mapping configuration.
1	Too Many Maps	Too many cyclic data channels configured.
2	No Mapping	Cyclic data length is 0 or there are no mappings.
3	Read Mismatch	The parameter may not exist.
4	Hole In Mapping	The cyclic data mapping parameters are not contiguous.
5	Duplicate Map	Two or more cyclic data mapping configuration parameters have been configured with the same destination.
6	Length Mismatch	The length of data doesn't match.
7	DSP402 Align	Data alignment must be set to 16 bits to allow the DSP 402 device profiles to be used.
8	Trans Type	The transmission type selected is not supported.

S.04.006	TPDOC Processing Time		
S.04.007	RPDOC Processing Time		
Minimum	0	Maximum	65535
Default	0	Units	ms
Type	16 Bit Volatile	Update Rate	Background
Display Format	None	Decimal Places	0
Coding	RO, ND, NC, PT, BU		

Pr **S.04.006** displays the time between receiving the output value from the drive and being sent successfully to the master.

Pr **S.04.007** displays the time between receiving the input value from the master and being sent successfully to the drive.

S.04.008	PDOC Input Consistency Enable		
S.04.010	PDOC Output Consistency Enable		
Minimum	0	Maximum	1
Default	0	Units	
Type	1 Bit User Save	Update Rate	Module reset / initialization
Display Format	None	Decimal Places	0
Coding	RW		

S.04.009	PDOC Input Consistency Trigger Parameter		
S.04.011	PDOC Output Consistency Trigger Parameter		
Minimum	0.00.000	Maximum	5.99.999
Default	0.00.000	Units	
Type	32 Bit User Save	Update Rate	Module reset / initialization
Display Format	Slot Menu Parameter	Decimal Places	0
Coding	RW, BU		

The SI-CANopen module provides an input/output consistency feature which ensures that the data in the input or output mappings is only transferred between the SI-CANopen module and the master when the mapped parameters are ready. This prevents data skew between parameters in the input/output mappings.

If PDOC Input Consistency Enable (Pr **S.04.008**) and PDOC Output Consistency Enable (Pr **S.04.010**) are set to 0 (i.e. default settings), then the input/output consistency features are disabled so that input and output data is always read from or written to the master/ module.

If PDOC Input Consistency Enable (Pr **S.04.008**) is set to On (1), the SI-CANopen module will check the value of the parameter specified by the PDOC Input Consistency Trigger Parameter (Pr **S.04.009**). If the PDOC Input Trigger Parameter defined by Pr **S.04.009** is set to a non-zero value (for example by a user program in an applications module), this indicates to the SI-CANopen module that all the mapped parameters are ready to be read. The module will then read the mapped parameters, transfer them to the master and will then clear the input trigger source parameter to zero. When the input trigger source parameter is set to zero, the SI-CANopen module will continue to transfer the previously read data to the master.

If PDOC Output Consistency Enable (Pr **S.04.010**) is set to On (1), the SI-CANopen module will check the value of the parameter specified by the PDOC Output Consistency Trigger Parameter (Pr **S.04.011**). The PDOC Output Trigger Parameter defined by Pr **S.04.011** will initially be set to 1.

If the output trigger source parameter is set to zero (for example by a user program in an applications module), this indicates to the SI-CANopen module that all the mapped parameters are ready to be written to. The module will then write the data from the master into the mapped parameters, and will then set the output trigger source parameter to 1. When the output trigger source parameter is set to 1, it indicates to the SI-CANopen module that the mapped parameters are not ready to be written to, and therefore any new data from the master will not be written to the mapped parameters in the drive until the output trigger source parameter is again set to zero.

S.04.012	PDOC Event Trigger		
Minimum	0	Maximum	1
Default	0	Units	
Type	1 Bit User Save	Update Rate	Module reset / initialization
Display Format	None	Decimal Places	0
Coding	RW		

When the transmission type (Pr **S.04.003**) is set to 254 (Manufacturer specific event), setting this parameter to On (1) triggers any PDOs configured to be transmitted or received PDOs acted upon. Once triggered, the module will reset the parameter to Off (0).

S.04.013	TPDOC Number		
S.04.014	RPDOC Number		
Minimum	0	Maximum	512
Default	5	Units	
Type	16 Bit User Save	Update Rate	Module reset / initialization
Display Format	None	Decimal Places	0
Coding	RW, BU		

There are four TPDOs and four RPDOs available in the SI-CANopen. These PDOs are referred to as PDOs A, B, C and D. Each of these PDOs can be configured to be any of the 512 available PDOs. By default the configuration will be PDOA = 1, PDOB = 3, PDOC = 5 and PDOD = 6 (for both TPDOs and RPDOs).

If a configuration using non-default or flexible numbering is required, the index number for the PDO communication objects must be derived by subtracting 1 from the PDO number and adding this number to the base address. e.g. for 0x1600 PDO3 = 0x1602 (mapping information for RPDOs).

S.04.015	TPDOC Mapping Parameter 1		
S.04.016	TPDOC Mapping Parameter 2		
S.04.017	TPDOC Mapping Parameter 3		
S.04.018	TPDOC Mapping Parameter 4		
S.04.019	RPDOC Mapping Parameter 1		
S.04.020	RPDOC Mapping Parameter 2		
S.04.021	RPDOC Mapping Parameter 3		
S.04.022	RPDOC Mapping Parameter 4		
Minimum	0.00.000	Maximum	5.99.999
Default	0.00.000	Units	
Type	32 Bit User Save	Update Rate	Module reset / initialization
Display Format	Slot Menu Param	Decimal Places	0
Coding	RW, BU		

Parameters **S.04.015** – **S.04.018** are used to define the application objects which are mapped to TPDOC.

Parameters **S.04.019** – **S.04.022** are used to define the application objects which are mapped to RPDOC.

Entering a value indicating that slot 5 is used will utilise the SI-CANopen module's parameter in the local slot allowing modules to be able to be moved in different slots. For example, 5.01.006 will use the CANopen Network Diagnostic parameter for the SI-CANopen module in the local slot.

6.7 Menu 5 – PDOD Setup

Menu 5 contains all the parameters relating the setup of PDOD.

S.05.001	TPDOD Length		
S.05.002	RPDOD Length		
Minimum	0	Maximum	4
Default	0	Units	
Type	8 Bit Volatile	Update Rate	Module reset / initialization
Display Format	None	Decimal Places	0
Coding	RW, NC		

Parameters **S.05.001** and **S.05.002** define the length of TPDOD and RPDOD respectively.

They are monitored in the background by the CANopen module. Attempts by the user to exceed the defined range will cause the module to reset the parameter value displayed to the relevant minimum or maximum.

S.05.003	TPDOD Transmission Type		
Minimum	0	Maximum	255
Default	255	Units	
Type	8 Bit Volatile	Update Rate	Module reset / initialization
Display Format	None	Decimal Places	0
Coding	RW, BU		

Pr **S.05.003** sets the current transmission type of TPDOD. As all PDOs are handled in the same way if the master changes this setting through the PDO configuration object the parameter will not be updated.

Transmission type	Cyclic	Acyclic	Synchronous	Asynchronous	RTR only
0		X	X		
1 – 240	X		X		
241 – 251	Reserved	Reserved	Reserved	Reserved	Reserved
252			X		X
253				X	X
254				X	
255				X	

- Type 0 transmits after a sync message, only when data has changed.
- Types 1 to 240 transmit every n sync messages.
- (Types 241 to 251 are reserved and will therefore produce an error if selected. See Pr **S.05.004**).
- Type 252 transmits only on remote request, data is updated on receipt of the sync message.
- Type 253 data updated and transmits only on remote request.
- Type 254 transmits when the TPDO- n event trigger parameter is set to on.
- Type 255 transmits on profile specific event.

The manufacturer specific (254) and profile specific even type (255) will be implemented to transmit the PDO every n ms where n is specified by sub-index 5 of the PDO communication parameter. This value will default to 0, which disables the transmission.

S.05.004	TPDOD Mapping Status		
S.05.005	RPDOD Mapping Status		
Minimum	0	Maximum	8
Default	0	Units	
Type	8 Bit Volatile	Update Rate	Background
Display Format	None	Decimal Places	0
Coding	RO, TE, NC, PT, BU		

The module will scan and check the CANopen mapping parameter configuration for errors during initialization. If an error is detected, the CANopen Network Diagnostic parameter (Pr **S.01.006**) will indicate "Config Error" (4) and the mapping error detected will be indicated in the relevant parameter.

The table below shows all possible values for Prs **S.05.004** and **S.05.005**.

Value	Text	Description
0	Mapping OK	No error detected with cyclic data mapping configuration.
1	Too Many Maps	Too many cyclic data channels configured.
2	No Mapping	Cyclic data length is 0 or there are no mappings.
3	Read Mismatch	The parameter may not exist.
4	Hole In Mapping	The cyclic data mapping parameters are not contiguous.
5	Duplicate Map	Two or more cyclic data mapping configuration parameters have been configured with the same destination.
6	Length Mismatch	The length of the data doesn't match.
7	DSP402 Align	Data alignment must be set to 16 bits to allow the DSP 402 device profiles to be used.
8	Trans Type	The transmission type selected is not supported.

S.05.006	TPDOD Processing Time		
S.05.007	RPDOD Processing Time		
Minimum	0	Maximum	65535
Default	0	Units	ms
Type	16 Bit Volatile	Update Rate	Background
Display Format	None	Decimal Places	0
Coding	RO, ND, NC, PT, BU		

Pr **S.05.006** displays the time between receiving the output value from the drive and being sent successfully to the master.

Pr **S.05.007** displays the time between receiving the input value from the master and being sent successfully to the drive.

S.05.008	PDOD Input Consistency Enable		
S.05.010	PDOD Output Consistency Enable		
Minimum	0	Maximum	1
Default	0	Units	
Type	1 Bit User Save	Update Rate	Module reset / initialization
Display Format	None	Decimal Places	0
Coding	RW		

S.05.009	PDOD Input Consistency Trigger Parameter		
S.05.011	PDOD Output Consistency Trigger Parameter		
Minimum	0.00.000	Maximum	5.99.999
Default	0.00.000	Units	
Type	32 Bit User Save	Update Rate	Module reset / initialization
Display Format	Slot Menu Parameter	Decimal Places	0
Coding	RW, BU		

The SI-CANopen module provides an input/output consistency feature which ensures that the data in the input or output mappings is only transferred between the SI-CANopen module and the master when the mapped parameters are ready. This prevents data skew between parameters in the input/output mappings.

If PDOD Input Consistency Enable (Pr **S.05.008**) and PDOD Output Consistency Enable (Pr **S.05.010**) are set to 0 (i.e. default settings), then the input/output consistency features are disabled so that input and output data is always read from or written to the master/ module.

If PDOD Input Consistency Enable (Pr **S.05.008**) is set to On (1), the SI-CANopen module will check the value of the parameter specified by the PDOD Input Consistency Trigger Parameter (Pr **S.05.009**). If the PDOD Input Trigger Parameter defined by Pr **S.05.009** is set to a non-zero value (for example by a user program in an applications module), this indicates to the SI-CANopen module that all the mapped parameters are ready to be read. The module will then read the mapped parameters, transfer them to the master and will then clear the input trigger source parameter to zero. When the input trigger source parameter is set to zero, the SI-CANopen module will continue to transfer the previously read data to the master.

If PDOD Output Consistency Enable (Pr **S.05.010**) is set to On (1), the SI-CANopen module will check the value of the parameter specified by the PDOD Output Consistency Trigger Parameter (Pr **S.05.011**). The PDOD Output Trigger Parameter defined by Pr **S.05.011** will initially be set to 1.

If the output trigger source parameter is set to zero (for example by a user program in an applications module), this indicates to the SI-CANopen module that all the mapped parameters are ready to be written to. The module will then write the data from the master into the mapped parameters, and will then set the output trigger source parameter to 1. When the output trigger source parameter is set to 1, it indicates to the SI-CANopen module that the mapped parameters are not ready to be written to, and therefore any new data from the master will not be written to the mapped parameters in the drive until the output trigger source parameter is again set to zero.

S.05.012	PDOD Event Trigger		
Minimum	0	Maximum	1
Default	0	Units	
Type	1 Bit User Save	Update Rate	Module reset / initialization
Display Format	None	Decimal Places	0
Coding	RW		

When the transmission type (Pr **S.05.003**) is set to 254 (Manufacturer specific event), setting this parameter to On (1) triggers any PDOs configured to be transmitted or received PDOs acted upon. Once triggered, the module will reset the parameter to Off (0).

S.05.013	TPDOD Number		
S.05.014	RPDOD Number		
Minimum	0	Maximum	512
Default	6	Units	
Type	16 Bit User Save	Update Rate	Module reset / initialization
Display Format	None	Decimal Places	0
Coding	RW, BU		

There are four TPDOs and four RPDOs available in the SI-CANopen. These PDOs are referred to as PDOs A, B, C and D. Each of these PDOs can be configured to be any of the 512 available PDOs. By default the configuration will be PDOA = 1, PDOB = 3, PDOC = 5 and PDOD = 6 (for both TPDOs and RPDOs).

If a configuration using non-default or flexible numbering is required, the index number for the PDO communication objects must be derived by subtracting 1 from the PDO number and adding this number to the base address. E.g. for 0x1600 PDO3 = 0x1602 (mapping information for RPDOs).

S.05.015	TPDOD Mapping Parameter 1		
S.05.016	TPDOD Mapping Parameter 2		
S.05.017	TPDOD Mapping Parameter 3		
S.05.018	TPDOD Mapping Parameter 4		
S.05.019	RPDOD Mapping Parameter 1		
S.05.020	RPDOD Mapping Parameter 2		
S.05.021	RPDOD Mapping Parameter 3		
S.05.022	RPDOD Mapping Parameter 4		
Minimum	0.00.000	Maximum	5.99.999
Default	0.00.000	Units	
Type	32 Bit User Save	Update Rate	Module reset / initialization
Display Format	Slot Menu Param	Decimal Places	0
Coding	RW, BU		

Parameters **S.05.015** – **S.05.018** are used to define the application objects which are mapped to TPDOD.

Parameters **S.05.019** – **S.05.022** are used to define the application objects which are mapped to RPDOD.

Entering a value indicating that slot 5 is used will utilise the SI-CANopen module's parameter in the local slot allowing modules to be able to be moved in different slots. For example, 5.01.006 will use the CANopen Network Diagnostic parameter for the SI-CANopen module in the local slot.

6.8 Menu 6 – RPDO Fault

Menu 6 contains all the parameters relating to the fault values for all RPDOs A, B, C and D.

S.06.001	PDOA Fault Value 1		
S.06.002	PDOA Fault Value 2		
S.06.003	PDOA Fault Value 3		
S.06.004	PDOA Fault Value 4		
S.06.005	PDOB Fault Value 1		
S.06.006	PDOB Fault Value 2		
S.06.007	PDOB Fault Value 3		
S.06.008	PDOB Fault Value 4		
S.06.009	PDOC Fault Value 1		
S.06.010	PDOC Fault Value 2		
S.06.011	PDOC Fault Value 3		
S.06.012	PDOC Fault Value 4		
S.06.013	PDOD Fault Value 1		
S.06.014	PDOD Fault Value 2		
S.06.015	PDOD Fault Value 3		
S.06.016	PDOD Fault Value 4		
Minimum	-2147483648	Maximum	2147483647
Default	0	Units	
Type	32 Bit User Save	Update Rate	Module reset / initialization
Display Format	None	Decimal Places	0
Coding	RW		

These parameters are used to define the value sent to the mapped RPDO destination when fault values have been configured to be sent using a timeout action parameter.

6.8.1 Menu 9 - Resources

S.09.030	PCB Temperature 1		
S.09.031	PCB Temperature 2		
Minimum	-128	Maximum	127
Default		Units	°C
Type	8 Bit Volatile	Update Rate	Background write
Display Format	None	Decimal Places	0
Coding	RO, ND, NC, PT		

Parameters **S.09.030** and **S.09.031** display the current temperature of the 2 internal thermistors inside the module.

7 Cyclic Data

7.1 What is a “Process Data Object”?

Cyclic data is implemented on SI-CANopen networks by using “Process Data Objects” or PDOs. Separate data objects are used for transmitting (TxPDOs) and receiving (RxPDOs) data. PDO configuration objects are usually pre-configured in the CANopen master controller and downloaded to the SI-CANopen network initialization using SDOs.

Mapping parameters are provided that can be used to configure RxPDO1 and TxPDO1 in CANopen (or the first configured PDO (A) if this has been changed using objects 0x2800 or 0x2801). These parameters are used to set default values in the PDO mapping objects during initialization.

NOTE Slot parameters (Pr **S.mm.ppp**) are only required for configuration of the first PDO when configuration is done without SDOs. Configuration should normally be done with SDOs, if supported by the master.

NOTE If the CANopen master controller over-writes the mapping objects, the mapping parameters are NOT automatically updated to indicate the new mappings, in the corresponding slot menus. TxPDO and RxPDO describe the direction of data transfer as seen by the nodes on a SI-CANopen network. By default TxPDOA (default TxPDO1) is configured as transmission type 255.

7.1.1 Additional PDOs and device profiles

SI-CANopen supports a total of four PDOs, plus 3 device profiles. For further information, refer to Chapter 12 *Diagnostics* on page 108.

7.1.2 Duplicate mapping

Care must be taken to ensure that there are no conflicts between the mapping of cyclic data and the analog and digital inputs within the drive itself. SI-CANopen will not indicate if there is a conflict with drive mapping parameters.

If a parameter is written to from two different sources, the value of this parameter will depend entirely upon the scan time for the parameter and the SI-CANopen network cycle. This may cause the value in the parameter to change continuously between 2 values.

7.2 PDO data mapping errors

SI-CANopen will scan and check the mapping parameter configuration for errors. If an error is detected, the drive will display an alarm; either ‘In Mapping’ or ‘Out Mapping’.

7.3 Unused PDO data channels

If any data words are not being used in an application, the un-used mapping parameters should be set to 0. Although the data word will still be transmitted over the CANopen network, any incoming data will be discarded by SI-CANopen, and unmapped data words being passed back to the CANopen master controller will be set to 0.

7.4 Changing PDO mapping parameters (via controller/PLC)

The mapping parameters for a PDO can only be modified when the number of mapped application objects in PDO (sub-index 0) is set to 0. This effectively disables the PDO while the mapping is modified using SDO communications.

Once all mapping parameters have been updated, the PDO sub-index 0 is set to specify the total number of defined mappings (normally 4 or 2). SI-CANopen will calculate the PDO length from the mappings, and activate the changes to the PDO mappings.

7.5 Blank mapping parameters (via controller/PLC)

If multiple SI-CANopen nodes are configured with the same COB-ID for an RxPDO, they will all receive the RxPDO at the same time. For example, in a system comprising four drives, RxPDO1 could be used to transmit a 16-bit speed reference to each node.

However, the RxPDO1 mapping in each node must be configured to use only one word received on RxPDO1, and discard all other words. This can be achieved by creating a “blank mapping”. For an RxPDO, data with a blank mapping will simply be discarded. TxPDO data values with a blank mapping will be set to 0.

Table 7.1 Blank mapping objects

Index	Object code	Name	Type	Access	PDO mapping
0x0002	DEFTYPE	INTEGER8	INTEGER8	RW	Yes
0x0003	DEFTYPE	INTEGER16	INTEGER16	RW	Yes
0x0004	DEFTYPE	INTEGER32	INTEGER32	RW	Yes
0x0005	DEFTYPE	UNSIGNED8	UNSIGNED8	RW	Yes
0x0006	DEFTYPE	UNSIGNED16	UNSIGNED16	RW	Yes
0x0007	DEFTYPE	UNSIGNED32	UNSIGNED32	RW	Yes

Unwanted data should be mapped to the DEFTYPE object of appropriate size. Bytes, words and double words are supported, but the BOOLEAN TYPE IS NOT SUPPORTED. The only other limitation is that there are only four mapping parameters per PDO, due to memory restrictions.

For example, consider RxPDOA (by default PDO1) containing four 16-bit speed references, one each for four different nodes. If a node needs to access only the 3rd word of RxPDOA and map it to Pr **18.011**, while ignoring the remaining words, the mapping configuration required is shown in Table 7.2.

Table 7.2 Example of blank mapping objects

Word	Object	Value
0	0x1600sub1	0x00030010
1	0x1600sub2	0x00030010
2	0x1600sub3	0x20120B10
3	0x1600sub4	0x00030010

NOTE Blank mapping objects allow the mappings to contain null references that are not possible by other means.

8 Non Cyclic Data

The “Service Data Object” or SDO provides the non-cyclic data channel on an CANopen system, and allows access to all objects in the CANopen object dictionary. Object access using SDO is controlled entirely by the controller/PLC.

Non-cyclic data transfer is implemented entirely in the CANopen controller/PLC. Control Techniques is unable to offer any specific technical support with regard to the implementation of non-cyclic data transfer with any particular CANopen system.

NOTE The non-cyclic data channel does not use decimal points. For example, in open loop mode, digital speed reference 1 (Pr **01.021**) has units of Hertz, accurate to one decimal place. To write a value of 24.6Hz to Pr **01.021**, the value must be transmitted as 246.

8.1 Service data object (SDO) parameter access

The service data object (SDO) provides access to all objects in the SI-CANopen object dictionary, and the drive parameters are mapped into the object dictionary as 0x2XXX objects in the following way:

Index: $0x2000 + (0x100 \times S) + menu$

Sub-index: Parameter

Where S is the slot number, a value of 0 represents the drive, 1 to 4 represents slots 1 to 4 respectively and 5 represents the local slot

For example, Pr **20.021** would be index $0x2014$ and the sub-index would be $0x15$. The values are usually expressed in base 16, so care must be taken to enter the correct parameter number.

All other supported entries in the CANopen object dictionary can also be accessed using SDOs. See Chapter 12 *CANopen reference* on page 99 for a full list of supported objects. Refer to the master controller documentation for full details about implementing SDO transfers within the particular master controller.

When accessing drive parameters using an SDO, all parameters must be treated as signed 32-bit parameters. If the target parameter is a 16-bit parameter, the data value will be cast to a 32-bit integer. The sign of the 16-bit value will be preserved.

The following SDO services are supported:

- Initiate SDO Download (*Write*)
- Initiate SDO Upload (*Read*)
- Abort SDO Transfer (*Error*)

8.1.1 SDO abort codes (errors)

SDO messages use a request-response mechanism and the CANopen master will always expect a response from the slave device. If an error occurs with an SDO transfer SI-CANopen will return an SDO abort code to indicate the reason for the failure, the SDO abort codes are listed in Table 8.1.

Table 8.1 SDO abort codes

Abort code (in hex.)	Description
0x05030000	Toggle bit not alternated.
0x05040000	SDO protocol timed out.
0x05040001	Client/server command specifier not valid or unknown.
0x05040002	Invalid block size (block mode only).
0x05040003	Invalid sequence number (block mode only).
0x05040004	CRC error (block mode only).
0x05040005	Out of memory.
0x06010000	Unsupported access to an object.
0x06010001	Attempt to read a write only object.
0x06010002	Attempt to write a read only object.
0x06020000	Object does not exist in the object dictionary.
0x06040041	Object cannot be mapped to the PDO.
0x06040042	The number and length of the objects to be mapped would exceed PDO length.
0x06040043	General parameter incompatibility.
0x06040047	General internal incompatibility in the device.
0x06060000	Access failed due to a hardware error.
0x06070010	Data type does not match, length of service parameter does not match.
0x06070012	Data type does not match, length of service parameter too high.
0x06070013	Data type does not match, length of service parameter too low.
0x06090011	Sub-index does not exist.
0x06090030	Value range of parameter exceeded (only for write access).
0x06090031	Value of parameter written too high.
0x06090032	Value of parameter written too low.
0x06090036	Maximum value is less than minimum value.
0x08000000	General error.
0x08000020	Data cannot be transferred or stored to the application.
0x08000021	Data cannot be transferred or stored to the application because of local control.
0x08000022	Data cannot be transferred or stored to the application because of the present device state.
0x08000023	Object dictionary dynamic generation fails or no object dictionary is present.

9 Control / status word

9.1 What are control and status words?

The control and status words allow the digital control and monitoring of the drive to be implemented using a single data word for each function. Each bit in the control word has a particular function and provides a method of controlling the output functions of the drive, such as run and direction.

Each bit in the status word provides feedback about the drive's state of health and operational condition, such as drive ok, drive at speed, etc.

9.2 Control word

The SI-CANopen control word consists of sixteen control bits some of which are reserved. See Table 9.1 for the individual bit function descriptions.

Table 9.1 Control word bit definitions

b15	b14	b13	b12	b11	b10	b9	b8
	KEYPAD WDOG	RESET	TRIP			JOG REV	REMOTE
b7	b6	b5	b4	b3	b2	b1	b0
AUTO	NOT STOP	RUN	FWD REV	RUN REV	JOG FWD	RUN FWD	ENABLE

To enable fieldbus control, the fieldbus enable signal (Pr **06.043**) and the auto bit (b7) must both be set to '1'. When the AUTO bit is reset to 0 the drive will revert to terminal control.

For safety reasons, the external **HARDWARE ENABLE** signal must be present before the fieldbus control word can be used to start the drive. This terminal is normally controlled by an external "Emergency Stop" circuit to ensure that the drive is disabled in an emergency situation.

The control word **REMOTE** bit directly controls the drive parameter Pr **01.042**, the function of which is to select the digital speed reference as the source of the drive's speed reference. When the **REMOTE** bit is reset to 0 the drive will revert to using the external analog speed reference.

The actual digital speed reference selected when **REMOTE** is set to 1 will be Pr **01.021**, which is also the default mapping for the fieldbus speed reference. However Pr **01.015** can be used to change which of the digital references is selected. For further details on the drive digital speed reference, please refer to the appropriate drive user guide.

Table 9.2 lists in detail the function of each control word bit. For further in-depth details about drive control words and sequencing bits please refer to the appropriate drive documentation.

NOTE When a trip occurs, the drive control word **MUST** be set to a safe, disabled state. This ensures that the drive does not re-start unexpectedly when it is reset. This can be achieved by continuously monitoring the drive status word, and interlocking it with the control word.

NOTE By default data alignment is set to 32 and therefore the control word will be cast as 32-bit with bits 16 to 31 reserved.

Table 9.2 Control word bit functions

Bit	Function	Description
0	ENABLE	Set to 1 to enable the drive. Resetting to 0 will immediately disable the drive, and the motor will coast to a stop. The external HARDWARE ENABLE signal must also be present before the drive can be enabled.
1	RUN FWD	Set to 1 (with ENABLE set to 1) to run the motor in the forward direction. When reset to 0, the drive will decelerate the motor to a controlled stop.
2	JOG FWD	Set to 1 to jog the motor forward. This signal needs to be used in conjunction with the ENABLE bit. This signal is overridden by a RUN, RUN REV or RUN FWD signal.
3	RUN REV	Set to 1 (with ENABLE set to 1) to run the motor in the reverse direction. When reset to 0, the drive will decelerate the motor to a controlled stop.
4	FWD REV	Set to 1 to select the reverse direction. Set to 0 to run in the forward direction. The RUN signal is used to start and stop the motor.
5	RUN	Set to 1 to run the motor. FWD REV is used to select the direction of motor rotation. When reset to 0, the drive will decelerate the motor to a controlled stop.
6	NOT STOP	Set to 1 to allow the sequencing bit to be latched. If NOT STOP is zero, all latches are cleared and held at 0. Pr 06.004 must be correctly set for this to function.
7	AUTO	Set to 1 to enable fieldbus control of the drive Control Word. The Control Word Enable (Pr 06.043) must also be set to 1. When reset to 0, the drive will operate under terminal control.
8	REMOTE	Set to 1 to select digital speed reference 1 (Pr 01.021), and reset to 0 to select analog reference 1 (Pr 01.036). REMOTE directly controls Pr 01.042 , so reference selector (Pr 01.014) and preset selector (Pr 01.015) must both be set to 0 (default) for the REMOTE bit to work properly.
9	JOG REV	Set to 1 to jog the motor in reverse. This signal needs to be used in conjunction with the ENABLE bit. This signal is overridden by a RUN/RUN REV/RUN FWD command.
10	Reserved	
11	Reserved	
12	TRIP	Set to 1 to trip the drive at any time. The trip display on drive will be CL.bit and the trip code will be 35. AUTO (b7) has no effect on this function. The trip cannot be cleared until TRIP is reset to 0.
13	RESET	A 0-1 transition of the RESET bit will reset the drive from a trip condition. If the reason for the trip is still present, or another fault condition has been detected, the drive will immediately trip again. When resetting the drive, it is recommended to check the status word to ensure that the reset was successful, before attempting to re-start the drive.
14	KEYPAD WDOG	This watchdog is provided for an external keypad or other devices where a break in the communication link must be detected. The watchdog system can be enabled and/or serviced if this bit is changed from zero to one while the control word enabled. Once the watchdog is enabled it must be serviced at least once every second or an SCL trip will occur. The watchdog is disabled when an SLC trip occurs, and so it must be re-enabled when the trip is reset.
15	Reserved	

9.3 Status word

The SI-CANopen status word consists of sixteen control bits some of which are reserved. See Table 9.3 for the individual bit function descriptions.

Table 9.3 Status word bit definitions

b15	b14	b13	b12	b11	b10	b9	b8
(Not used)	Supply loss	Reverse direction running	Reverse direction commanded	Brake resistor alarm	Braking IGBT active	Regenerating	Current limit active
b7	b6	b5	b4	b3	b2	b1	b0
Rated load reached	Above set speed	At set speed	Below set speed	Running at or below minimum speed	Zero speed	Drive active	Drive OK/healthy

The fieldbus status word is mapped directly from the drive status word, Pr **10.040**.

Pr **10.040** is generated by the values of several individual drive status bits; Table 9.4 shows the function indicated by each bit in the status word when set to 1.

Table 9.4 Drive status word bit functions

Bit	Parameter	Description
0	Pr 10.001	bit 0 = 0: Drive not ok (tripped). bit 0 = 1: Drive ok.
1	Pr 10.002	Drive active When bit 1 = 1, the drive is in run mode.
2	Pr 10.003	Zero speed In Open Loop mode, zero speed indicates that the absolute value of the post-ramp speed reference is at or below the zero speed threshold. In RFC-A and RFC-S modes, zero speed indicates that the absolute value of speed feedback is at or below the zero speed threshold.
3	Pr 10.004	Running at or below minimum speed In bipolar mode (Pr 01.010 = 1) Pr 10.004 is the same as zero speed, Pr 10.003. (See above.) In unipolar mode, Pr 10.004 is set if the absolute value of the post-ramp speed reference (Pr 02.001) or speed feedback (Pr 03.002) is at or below minimum speed + 0.5Hz or 5 rpm. (Minimum speed is defined by Pr 01.007.) This parameter is only set if the drive is running.
4	Pr 10.005	Below set speed Only set if the drive is running at below set speed. Refer to Pr 03.006, Pr 03.007 and Pr 03.009 in the drive documentation for more details.
5	Pr 10.006	At speed Only set if the drive is running at set speed. Refer to Pr 03.006, Pr 03.007 and Pr 03.009 in the drive documentation.
6	Pr 10.007	Above set speed Only set if the drive is running at above set speed. Refer to Pr 03.006, Pr 03.007 and Pr 03.009 in the drive documentation for more details.
7	Pr 10.008	Load reached Indicates that the modulus of the active current is greater or equal to the rated active current, as defined in menu 4. Refer to the drive documentation for more details.
8	Pr 10.009	In current limit Indicates that the current limits are active.
9	Pr 10.010	Regenerating Indicates that power is being transferred from the motor to the drive. Regen mode: Indicates that power is being transferred from the drive to the supply.
10	Pr 10.011	Dynamic brake active Indicates that the braking IGBT is active. If the IGBT becomes active, this parameter will remain on for at least one second.
11	Pr 10.012	Dynamic brake alarm Dynamic brake alarm is set when the braking IGBT is active, and the braking energy accumulator is greater than 75%.
12	Pr 10.013	Reverse direction commanded Direction commanded is set to 1 if the Pre-ramp speed reference (Pr 01.003) is negative and reset to 0 if the Pre-ramp speed reference is zero or positive.
13	Pr 10.014	Reverse direction running A 0 indicates forward direction and a 1 indicates reverse direction. The source of this bit is Pr 02.001 for open loop mode and Pr 03.002 for RFC-A and RFC-S modes.
14	Pr 10.015	Supply loss Supply loss indicates that the drive has detected a supply loss from the level of the DC bus voltage. This parameter can only become active if supply loss ride through or supply loss stop modes are selected. In regen mode, supply loss is the inverse of Pr 03.007.
15	(Not Used)	Reserved

10 EDS Files

10.1 What are EDS files?

EDS (Electronic Data Sheets) files are text files that are used by CANopen network configuration software tools. They contain information about the device, such as manufacturer, product type, product code, etc., and they also provide information on the default settings and functions supported by the device. Mapping information is also included that allows access to device parameters over the CANopen network.

EDS files are not downloaded to the PLC or scanner, and are only used during network configuration. It is actually possible to configure a network without the EDS files.

10.2 Generic EDS files

Generic EDS files are available for all supported drives. These files are available from your local Control Techniques Drive Centre or supplier.

Drive icon files are also supplied for use with the SI-CANopen configuration software being used. EDS files must usually be installed into the software package being used to configure a CANopen network. Refer to the software documentation supplied with the master for instructions on how to install EDS files. Control Techniques cannot provide specific technical support for any of these software packages.

11 CANopen reference

11.1 CANopen object dictionary

The CANopen Object Dictionary defines a series of objects which contain data values in order to configure SI-CANopen.

11.1.1 Communication profile objects supported

Quick reference links to all communication object sections can be found in Chapter 12 *Diagnostics* on page 108.

Table 11.1 Profile objects

Index	Name	PDO mapping
0x1000	Device Type	No
0x1001	Error register	No
0x1002	Manufacturer Status Register	No
0x1003	Pre-defined Error Field	No
0x1005	COB-ID SYNC	No
0x1008	Manufacturer Device Name	No
0x1009	Manufacturer Hardware Version	No
0x100A	Manufacturer Software Version	No
0x1010	Store parameters	No
0x1011	Restore default parameters	No
0x1014	COB-ID EMCY	No
0x1016	Consumer Heartbeat Time	No
0x1017	Producer Heartbeat Time	No
0x1018	Identity Object	No
0x1400 - 0x15FF	Communication Information for RxPDOs	No
0x1600 - 0x17FF	Mapping Information for RxPDOs	No
0x1800 - 0x19FF	Communication Information for TxPDOs	No
0x1A00 - 0x1BFF	Mapping Information for TxPDOs	No

Table 11.2 Manufacturer specific objects

Object	Name
0x2820	RxPDO-A event configuration
0x2821	RxPDO-B event configuration
0x2822	RxPDO-C event configuration
0x2823	RxPDO-D event configuration
0x2830	SYNC event configuration
0x2831	Missed heartbeat event configuration
0x2832	TxPDO profile specific mode
0x2840	RxPDO-A trigger configuration
0x2841	RxPDO-B trigger configuration
0x2842	RxPDO-C trigger configuration
0x2843	RxPDO-D trigger configuration
0x2850	TxPDO-A trigger configuration
0x2851	TxPDO-B trigger configuration
0x2852	TxPDO-C trigger configuration
0x2853	TxPDO-D trigger configuration

11.2 Basic data types

These are basic data types and are available in order to facilitate the need to set mappings to parameters of null values (i.e. when creating blank mappings). 'In' mappings or TxPDOs to these objects will return 0. An 'out' mapping or RxPDO will reference a null object of predefined size. For example, if only a single 16 bit word is used within a PDO the remaining words that are unused within the particular drive should be mapped to a null data type of the appropriate size.

Index	Name	Size
0x0002	Integer8	8
0x0003	Integer16	16
0x0004	Integer32	32
0x0005	Unsigned8	8
0x0006	Unsigned16	16
0x0007	Unsigned32	32

11.3 Device type

Index	0x1000	Sub-index	0	Access	RO
Default	N/A	Data type	UNSIGNED32	Object code	VAR

device type indicates the current configuration of the drive and SI-CANopen and is used by some CANopen master controllers to ensure that the correct EDS file is being used.

Additional information		Device profile number
Mode	Type	
b31-b24 Refer to Table 11.4	b23-b16 Refer to Table 11.3	b15-b0 Refer to Table 11.3

device type is constructed using the values as indicated in Table 11.3 and Table 11.4.

Table 11.3 Device profile number and type

Type	Device profile number	Description
0x00	0x0000	All device profiles are disabled.
0x01	0x0192	Device profile DS402 V1.1 enabled, drive is running in RFC-S, open loop or regen mode. Basic implementations of two DSP402 device profiles (profile torque and velocity) have been included in the SI-CANopen, and supported objects are detailed in this section. Additional features may be implemented in an SI-Applications DPL program (where supported). See also section 11.18 <i>Device profiles</i> on page 96.
0x03	0x0192	Device profile DS402 V1.1 enabled, drive is running in RFC-A or RFC-S mode. Device profile DS402 V1.1 enabled, drive is running in RFC-A or RFC-S mode (see section Basic implementations of two DSP402 device profiles (profile torque and velocity) have been included in the SI-CANopen, and supported objects are detailed in this section. Additional features may be implemented in an SI-Applications DPL program (where supported). See also section 11.18 <i>Device profiles</i> on page 96.

The mode byte is manufacturer-specific and is specified in Table 11.4.

Table 11.4 Mode Bytes

Mode	Setting	Description
b26-b24	Drive mode	Indicates the operating mode of the drive. 0 = SE mode (000) 1 = open loop (001) 2 = RFC-A (010) 3 = RFC-S (011) 4 = regen (111)
b27	Data compression enabled	Set to 1 if data alignment (Pr S.01.014) is enabled. This affects the data size used by drive parameters, so a different EDS file must be used.
b31-b28	Reserved	Reserved.

11.3.1 Error register

Index	0x1001	Sub-index	0	Access	RO
Default	N/A	Data type	UNSIGNED8	Object code	VAR

The **error register** is used by SI-CANopen to indicate that an error has occurred. If a bit is set to 1, the specified error has occurred. The **error register** is part of the emergency object, refer to *section 11.16 Emergency object on page 94* for further details.

Bit	Error
0	Generic error
1	Current
2	Voltage
3	Temperature
4	Reserved
5	Reserved
6	Reserved
7	Manufacturer specific

11.3.2 Manufacturer status register

Index	0x1002	Sub-index	0	Access	RO
Default	N/A	Data type	UNSIGNED32	Object code	VAR

The **manufacturer status register** is mapped directly to the status word (Pr **10.040**) in the drive. See *section 9.3 Status word on page 59* for more details about the drive status word.

11.3.3 Pre-defined error field

Index	0x1003
Object code	ARRAY
Data type	UNSIGNED32

The **pre-defined error field** returns a 32-bit error code containing data from the last four emergency messages that were sent. If less than four emergency objects have been sent, the higher sub-indexes will not exist.

Byte 3	Byte 2	Byte 1	Byte 0
Drive trip code (Pr 10.020)	SI-CANopen error code	Emergency object error code	

number of errors

Index	0x1003	Sub-index	0	Access	RO
Default	4	Data type	UNSIGNED8	Object code	VAR

Sub-index 0 is an unsigned8 data type which indicates the highest sub-index for the **pre-defined error field**. The rest of the array are unsigned32 data types.

error field 1

Index	0x1003	Sub-index	1	Access	RO
Default	N/A	Data type	UNSIGNED32	Object code	VAR

Returns the last emergency object codes.

error field 2

Index	0x1003	Sub-index	2	Access	RO
Default	N/A	Data type	UNSIGNED32	Object code	VAR

Returns the 2nd last emergency object codes.

error field 3

Index	0x1003	Sub-index	3	Access	RO
Default	N/A	Data type	UNSIGNED32	Object code	VAR

Returns the 3rd last emergency object codes.

error field 4

Index	0x1003	Sub-index	4	Access	RO
Default	N/A	Data type	UNSIGNED32	Object code	VAR

Returns the 4th last emergency object codes.

11.3.4 COB-ID SYNC

Index	0x1005	Sub-index	0	Access	RW
Default	0x00000080	Data type	UNSIGNED32	Object code	VAR

COB-ID SYNC defines the COB-ID that will be used for the synchronization (SYNC) object. The SI-CANopen receives the SYNC message, but it cannot be used to generate the SYNC object.

b31	b30	b29	b28 - b11	b10 - b0
0	0	0	000000000000000000	11-bit CAN-ID

The upper 3 bits (b31-b29) are used to specify the SYNC behavior of SI-CANopen.

Bit	Value	Comment
31	0	Reserved.
30	0	SI-CANopen consumes the SYNC message.
29	0	11-bit CAN identifier.

Refer to section 11.6.3 *RxPDO transmission type* on page 71 and section 11.8.3 *TxPDO transmission type* on page 74 for details of the transmission types that use the SYNC object.

11.3.5 Manufacturer device name

Index	0x1008	Sub-index	0	Access	CONST
Default	SI-CANopen	Data type	STRING	Object code	VAR

Returns the string "SI-CANopen" to indicate the product name.

11.3.6 Manufacturer hardware version

Index	0x1009	Sub-index	0	Access	CONST
Default	UF707	Data type	STRING	Object code	VAR

Returns the string "UF707" to indicate the product hardware.

11.3.7 Manufacturer software version

Index	0x100A	Sub-index	0	Access	CONST
Default		Data type	STRING	Object code	VAR

Returns a string to indicate the firmware version installed. The string will be formatted as "Vwwwxyzz".

11.3.8 Store parameters

This object (0x1010) supports the saving of parameters in non-volatile memory.

Index	Sub-index	Description
0x1010	0	Will return 1 when read to indicate that the "save all parameters" option is supported.
0x1010	1	Will return 1 when read to indicate that the module can save parameters. Writing the save signature of 0x65766173 will cause the following actions. Pr mm.000 = 1000 Set the drive to save its parameters. Pr 10.038 = 100 Reset the drive to perform the save. Writing this signature will also save all objects where storage is supported.

The module reset that follows the parameter save will be inhibited to prevent loss of communications. It is recommended that this procedure is done once during commissioning/start up.

11.3.9 Restore default parameters

With this object (0x1011) the default values of parameters according to the communication or device profile are restored.

Index	Sub-index	Description
0x1011	0	Will return 1 when read to indicate that the “restore default parameters” option is supported.
0x1011	1	Will return 1 when read to indicate that the module can restore parameters. Writing the save signature of 0x64616F6C will cause the following actions. Pr S.01.003 = 1 Set the module to restore its defaults. Writing this signature will also default all objects where supported.

The module reset that follows the parameter save will be inhibited to prevent loss of communications. This will allow the communication parameters to be configured prior to a reset.

Stored objects

The following objects will always be stored in internal flash.

- 0x1005 – COB-ID SYNC
- 0x1014 – COB-ID EMCY
- 0x1016 - Consumer Heartbeat Time
- 0x1017 – Producer Heartbeat time
- 0x1400 - 0x1BFF – PDO configuration objects
- 0x2820-0x2833 - RxPDO event configuration
- 0x2830 - SYNC event configuration
- 0x2831 - Missed Heartbeat event configuration
- 0x2832 - TxPDO profile specific mode
- 0x2840-0x2843 - RxPDO trigger configuration
- 0x2850-0x2853 - TxPDO trigger configuration

The following objects will only be stored in internal memory if profiles are enabled and SI-CANopen over-riding is not enabled.

- 0x6042 – vl_target_velocity
- 0x6044 – vl_control_effort
- 0x6046 – vl_velocity_min_max_amount
- 0x6048 – vl_velocity_acceleration
- 0x6049 – vl_velocity_deceleration
- 0x604C – vl_dimension_factor
- 0x605A – quick_stop_option_code
- 0x605B – shut_down_option_code
- 0x605C – disable_operation_option_code
- 0x6060 – modes_of_operation
- 0x6071 – target_torque
- 0x6087 – torque_slope
- 0x6088 – torque_profile_type

Objects defined by object association in an SI-Applications module will not get saved in internal flash due to the time required to discover available objects and the space that would be required to store the potentially large number of objects. If these objects need saving then it will be the responsibility of the user program to ensure they are stored.

11.3.10 COB-ID EMCY

Index	0x1014	Sub-index	0	Access	RW
Default	0x00000080 + node address	Data type	UNSIGNED32	Object code	VAR

COB-ID EMCY defines the COB-ID to be used for the emergency object.

b31	b30	b29	b28 - b11	b10 - b0
0	0	0	0000000000000000	11-bit ID

The upper 3 bits (b31-b29) are used to specify the emergency object behavior of SI-CANopen.

Table 11.5 COB-ID SYNC configuration

Bit	Value	Comment
31	0	EMERGENCY object always exists
30	0	Reserved
29	0	11-bit CAN identifier

Refer to *section 11.16 Emergency object on page 94* for full details about the emergency object.

11.3.11 Producer heartbeat time

Index	0x1017	Sub-index	0	Access	RW
Default	0	Data type	UNSIGNED16	Object code	VAR

The “heartbeat protocol” is a node protection system or error control service. A “heartbeat producer” is usually a SI-CANopen slave device which transmits a heartbeat message cyclically. This message is received by one or more “heartbeat consumer” devices, usually the SI-CANopen master controller, and indicates to the master controller that the slave device is communicating successfully.

If the heartbeat message is not received within the defined time period, a “heartbeat event” will be generated in the master controller, allowing it to take appropriate action to ensure system safety is maintained.

The producer heartbeat time defines the cyclic time period (in milliseconds) for SI-CANopen to transmit the heartbeat message. A value of 0 disables the heartbeat message. The heartbeat message also includes the current NMT state of the SI-CANopen.

Table 11.6 SI-CANopen operating states

State	Operating state
0	BOOTUP
4	STOPPED
5	OPERATIONAL
127	PRE-OPERATIONAL

The SI-CANopen will start transmitting the heartbeat message as soon as it is enabled. If the **producer heartbeat time** is set >0 at power up, SI-CANopen will start transmitting the heartbeat message when the transition from BOOTUP to PRE-OPERATIONAL occurs. In this case, the boot-up message is regarded as the first heartbeat message.

11.3.12 Identity object

Index	0x1018
Object code	RECORD
Data type	UNSIGNED32

Identity object returns general information about the SI-CANopen.

Number of entries

Index	0x1018	Sub-index	0	Access	RO
Default	4	Data type	UNSIGNED8		

Returns the highest sub-index available for the identity object.

Vendor ID

Index	0x1018	Sub-index	1	Access	RO
Default	0xF9	Data type	UNSIGNED32		

Returns the SI-CANopen vendor ID (0xF9) for Control Techniques.

Product code

Index	0x1018	Sub-index	2	Access	RO
Default	448	Data type	UNSIGNED32		

Returns the SI-CANopen module ID code of 448.

Revision number

Index	0x1018	Sub-index	3	Access	RO
Default	N/A	Data type	UNSIGNED32		

Returns the SI-CANopen firmware version. **Revision number** will consist of Pr **S.00.002**.

Serial number

Index	0x1018	Sub-index	4	Access	RO
Default	N/A	Data type	UNSIGNED32		

Returns the SI-CANopen serial number. This value is programmed during manufacture and cannot be changed.

11.4 Flexible PDO numbering (0x2800 and 0x2801)

This functionality is supported from Version 02.01.00 onwards. The behavior of the PDO configuration objects will be changed in order to conform to the CANopen specification, while still offering as much flexibility as possible. There are four Tx and four Rx PDOs available in the module, these PDOs will be referred to as PDOs A, B, C and D. Each of these PDOs can be configured to be any of the 512 available PDOs, by default the configuration will be PDOA = 1, PDOB = 3, PDOC = 5 and PDOD = 6 (for both TxPDOs and RxPDOs). The configuration of available PDOs will be possible through 2 new manufacturer specific objects accessible by the SDOs.

If a configuration using non-default or flexible numbering is required, the index number for the PDO communication objects must be derived by subtracting 1 from the PDO number and adding this number to the base address e.g. for 0x1600 PDO3 = 0x1602 (mapping information for RxPDOs).

11.5 Mapping parameter values

When setting up cyclic data to contain specific parameters this may be done in two ways:

1. The first method is to use the mapping parameters Pr **S.02.015 - S.02.018** and **S.02.019 - S.02.022** (although this is limited to a single Rx and Tx PDO).
2. The second is to use SDOs to set the mappings. When this is done the entries take the following form:

b31 – b16	b15 – b8	b7 – b0
Index	Sub-index	Object length (in bits)

These are used with object 0x1600 - 0x17FF and object 0x1A00 - 0x1BFF for RxPDO and TxPDO mapping respectively. To map RxPDOA(1) to Pr **01.021**, the mapping parameter would be set to 0x20011520 (index = 0x2001, sub-index = 0x15, object length = 0x20, i.e. 32 bits). Refer to section 8.1 *Service data object (SDO) parameter access* on page 55 for details on how to access drive parameters.

11.5.1 RxPDO number configuration

This object will be used for configuring the available RxPDOs.

Index	0x2800	Sub-index	0	Access	RO
Largest sub-index supported		Value = 4			

Index	0x2800	Sub-index	1	Access	RW
PDO number for RxPDO A*		Range 0 to 511			

Index	0x2800	Sub-index	2	Access	RW
PDO number for RxPDO B*		Range 0 to 511			

Index	0x2800	Sub-index	3	Access	RW
PDO number for RxPDO C*		Range 0 to 511			

Index	0x2800	Sub-index	4	Access	RW
PDO number for RxPDO D*		Range 0 to 511			

Index	Sub-index	Description
0x2800	0	Will return 4 when read indicating the maximum sub-index and number of PDOs supported.
0x2800	1- 4	Are used to read and set the RxPDO number for each of the four configurable RxPDOs. The number is specified as required number less 1. That is PDO1 would be represented as 0.

NOTE * The actual index number is calculated by subtracting 1 from the PDO number and adding this number to the base address e.g. for 0x1600 PDO3 = 0x1602.

11.5.2 TxPDO number configuration

This object will be used for configuring the available TxPDOs.

Index	0x2801	Sub-index	0	Access	RO
Largest sub-index supported		Value = 4			

Index	0x2801	Sub-index	1	Access	RW
PDO number for TxPDO A*		Range 0 to 511			

Index	0x2801	Sub-index	2	Access	RW
PDO number for TxPDO B*		Range 0 to 511			

Index	0x2801	Sub-index	3	Access	RW
PDO number for TxPDO C*		Range 0 to 511			

Index	0x2801	Sub-index	4	Access	RW
PDO number for TxPDO D*		Range 0 to 511			

Index	Sub-index	Description
0x2801	0	Will return 4 when read indicating the maximum sub-index and number of PDOs supported.
0x2801	1- 4	Are used to read and set the TxPDO number for each of the four configurable TxPDOs. The number is specified as required number less 1. That is PDO1 would be represented as 0.

NOTE * The actual index number is calculated by subtracting 1 from the PDO number and adding this number to the base address e.g. for 0x1600 PDO3 = 0x1602.

11.5.3 Communication information for RxPDO

This section contains the communication parameters for the receive PDOs.

Index	0x1400-0x15FF	Sub-index	0	Access	RO
Largest sub-index supported		Size			

Index	0x1400-0x15FF	Sub-index	1	Access	RO
COB-ID used by PDO		Size			

Index	0x1400-0x15FF	Sub-index	2	Access	RW
Transmission type		Size			

Index	0x1400-0x15FF	Sub-index	3	Access	RW
Inhibit time (not used for RxPDO)		Size			

Index	0x1400-0x15FF	Sub-index	4	Access	RW
Compatibility entry		Size			

Index	0x1400-0x15FF	Sub-index	5	Access	RW
Event timer		Size			

11.6 RxPDO communication parameters

Index	0x1400-0x15FF
Object code	Record
Data type	PDOCommPar

This section contains the communication parameters for the RxPDOs.

SI-CANopen supports a total of four RxPDOs. Each PDO has a main index assigned to it, with individual parameters for the PDO accessed using sub-indices.

Table 11.7 Supported RxPDOs

RxPDO	Index
A	0x1400-0x15FF
B	0x1400-0x15FF
C	0x1400-0x15FF
D	0x1400-0x15FF

All RxPDO configuration parameters are dynamic (any changes made to these parameters will take effect immediately).

11.6.1 Number of entries

Index	0x1400-0x15FF	Sub-index	0
Data type	UNSIGNED8	Access	RO

Defines the largest sub-index supported for the specified RxPDO.

Table 11.8 RxPDO number of entries

RxPDO	Index	Value
A	0x1400-0x15FF	5
B	0x1400-0x15FF	5
C	0x1400-0x15FF	5
D	0x1400-0x15FF	5

NOTE Where the range for the index is determined by the PDO numbers set in object 0x2800.

11.6.2 RxPDO COB-ID

Index	0x1400-0x15FF	Sub-index	1
Data type	UNSIGNED32	Access	RW

The COB-ID is the CAN identifier used by the SI-CANopen master controller to send RxPDO messages over the SI-CANopen network. The COB-ID is usually calculated using the target slave node address, allowing each node to determine which RxPDO message it should use.

RxPDO COB-IDs do not have to be unique in slave devices on a CANopen network, as they can only originate from the CANopen master controller. It is common for a master controller to send a single RxPDO message containing four different speed or position references and have four different slave nodes configured to receive the same RxPDO. Each node simply extracts the reference it requires and discards the remaining data.

This makes efficient use of the available bandwidth of the CANopen network, as a single message is used to update four slave devices with new speed or position references, instead of four messages.

b31	b30	b29	b28 - b11	b10 - b0
RxPDO Disable	Reserved	29-bit ID Enable	00000000000000000	11-bit ID

The upper 3 bits (b31-b29) are used to enable certain functions of the RxPDO.

Function	Comment
PDO Disable	Set to 1 to disable the PDO. SI-CANopen will ignore any messages that are received with the specified 11-bit ID
29-bit ID Enable	SI-CANopen hardware does not support 29-bit CAN identifiers.so this bit must always be 0

DSP301 V4.1 specifies default COB-ID values for RxPDO1 to RxPDO4, while all higher RxPDOs must be disabled by default. Default values for the RxPDO COB-IDs are shown in Table 11.9.

Table 11.9

PDO	Index	Default COB-ID
A	0x1400	0x80000200 + node address.
B	0x1402	0x80000300 + node address.
C	0x1404	0x80000400 + node address.
D	0x1405	0x80000500 + node address.

NOTE RxPDO numbers above four are defaulted to a COB-ID of 0x80000000.

11.6.3 RxPDO transmission type

Index	0x1400-0x15FF	Sub-index	2
Data type	UNSIGNED8	Access	RW

The transmission type defines when data received in an RxPDO is processed and passed though to the target parameters. SI-CANopen supports all CANopen transmission modes.

Transmission type	Timing	Description
0 - 240	Synchronous	The RxPDO data is written to the target parameters when the next SYNC message is received.
241 - 251		Reserved.
252 - 253		Not used for RxPDOs.
254	Asynchronous	The RxPDO data is written to the target parameters when an OFF-to-ON (0-to-1) transition occurs in Pr S.MM.012 (where MM = 2, 3, 4 or 5). Pr S.MM.012 (where MM = 2, 3, 4 or 5) must be reset to OFF for a minimum of 1 ms to allow the RxPDO to be updated on the next OFF-ON transition. This allows the RxPDO update to be controlled by a digital input.
255	Asynchronous	The RxPDO data is written immediately to the target parameters.

Default values for the RxPDO COB-ID are shown in Table 11.10.

Table 11.10

RxPDO	Index	Default
A	0x1400	255
B	0x1402	255
C	0x1404	255
D	0x1405	255

11.6.4 RxPDO inhibit time

Index	0x1400-0x15FF	Sub-index	3
Data type	USIGN16	Access	RW

Inhibit time is not used for RxPDOs.

11.6.5 RxPDO event timer

Index	0x1400-0x15FF	Sub-index	5
Data type	USIGN16	Access	RW

Event timer is not used for RxPDOs.

11.7 RxPDO mapping parameters

The default configuration for SI-CANopen is RxPDOs 1, 3, 5 & 6 and TxPDOs 1, 3, 5 & 6, this however may be changed using objects 0x2800 and 0x2801 (section 11.5.1 RxPDO number configuration on page 68). The destination parameters for data received from an RxPDO are specified in the RxPDO mapping parameters.

Four mapping parameters are provided for each RxPDO, allowing data to be mapped to all drive and SI-Applications parameters. RxPDO data can also be mapped to all SI-CANopen object dictionary entries that allow PDO mapping.

The default mappings for RxPDOA (1) are derived from the mapping parameters (Pr **S.02.019** to Pr **S.02.022**) during initialization however, the mappings for all RxPDOs are dynamic, so changes made to the CANopen object dictionary mapping parameters (using SDO communications) will override settings made in the drive menu refer to section 7.4 *Changing PDO mapping parameters (via controller/PLC)* on page 53. Default mappings for RxPDOA(1) are shown in Table 11.11. RxPDO1 is enabled by default.

Index	Sub-index	Description	Data type	Access
0x1600	0	No of mapped application objects in RxPDO	UNSIGNED8	RW
0x1600	1	Channel 0 mapping	UNSIGNED32	RW*
0x1600	2	Channel 1 mapping	UNSIGNED32	RW*
0x1600	3	Channel 2 mapping	UNSIGNED32	RW*
0x1600	4	Channel 3 mapping	UNSIGNED32	RW*

NOTE * - read/write only if the number of mapped application objects in RxPDO (Index 0x160N sub 0) is set to 0. Refer to section 7.4 *Changing PDO mapping parameters (via controller/PLC)* on page 53.

NOTE The actual index number is calculated by subtracting 1 from the PDO number and adding this number to the base address e.g. for 0x1600 PDO3 = 0x1602.

Table 11.11 RxPDOA (by default RxPDO 1) default mapping

Index	Sub-index	Description	Default	Mapping destination
0x1600	0	Number of mapped objects in RxPDO1	2	2 objects mapped by default
0x1600	1	Channel 0 mapping	0x20062A20	Pr 06.042
0x1600	2	Channel 1 mapping	0x20011520	Pr 01.021
0x1600	3	Channel 2 mapping	0x00000000	Not used with default mappings
0x1600	4	Channel 3 mapping	0x00000000	

NOTE The actual index number is calculated by subtracting 1 from the PDO number and adding this number to the base address e.g. for 0x1600 PDO3 = 0x1602.

Table 11.12 RxPDOD (by default RxPDO 6) default mapping

Index	Sub-index	Description	Default	Mapping destination
0x1605	0	Number of mapped objects in RxPDO6	2	2 objects mapped by default
0x1605	1	Channel 0 mapping	0x60400010	controlword
0x1605	2	Channel 1 mapping	0x60420010	vl_target_velocity
0x1605	3	Channel 2 mapping	0x00000000	Not used with default mappings
0x1605	4	Channel 3 mapping	0x00000000	

NOTE The actual index number is calculated by subtracting 1 from the PDO number and adding this number to the base address e.g. for 0x1600 PDO3 = 0x1602.

11.8 TxPDO communication parameters

Index	0x1800-0x19FF
Object code	Record
Data type	PDOCommPar

This section contains the communication parameters for the TxPDOs.

SI-CANopen supports a total of four TxPDOs. Each PDO has a main index assigned to it, with individual parameters for the PDO accessed using sub-indexes.

Table 11.13 Supported TxPDOs (default settings)

TxPDO	Index
A	0x1800-0x19FF
B	0x1800-0x19FF
C	0x1800-0x19FF
D	0x1800-0x19FF

All TxPDO configuration parameters are dynamic, i.e. any changes made to these parameters will take effect immediately.

NOTE The actual index number is calculated by subtracting 1 from the PDO number and adding this number to the base address e.g. for 0x1800 PDO3 = 0x1802.

11.8.1 Number of entries

Index	0x1800-0x19FF	Sub-index	0	Access	RO
Default	5	Data type	UNSIGNED8		

Defines the largest sub-index supported for the specified TxPDO.

TxPDO	Index	Value
A	0x1800-0x19FF	5
B	0x1800-0x19FF	5
C	0x1800-0x19FF	5
D	0x1800-0x19FF	5

NOTE The actual index number is calculated by subtracting 1 from the PDO number and adding this number to the base address e.g. for 0x1600 PDO3 = 0x1602.

11.8.2 TxPDO COB-ID

Index	0x1800-0x19FF	Sub-index	1
Data type	UNSIGNED32	Access	RW

The COB-ID is the CAN identifier used by SI-CANopen to transmit TxPDO messages over the SI-CANopen network. The COB-ID is usually calculated using the node address, as this will ensure that the TxPDO COB-ID is unique on the SI-CANopen network.

b31	b30	b29	b28 - b11	b10 - b0
PDO Disable	RTR Disable	29-bit ID Enable	000000000000000000	11-bit ID

The upper 3 bits (b31-b29) are used to enable certain functions of the TxPDO.

Table 11.14 PDO COB-ID configuration

Function	Comment
PDO Disable	Set to 1 to disable the TxPDO. SI-CANopen will not transmit the TxPDO.
RTR Disable	Set to 1 to disable RTR with the TxPDO.
29-bit ID Enable	SI-CANopen hardware does not support 29-bit CAN identifiers so this bit must always be 0.

DSP301 V4.1 specifies default COB-ID values for TxPDO1 to TxPDO4, while all higher TxPDOs must be disabled by default. Default values for the TxPDO COB-IDs are shown in Table 11.15.

Table 11.15 TxPDO COB-ID default values

TxPDO	Index	Default COB-ID
A	0x1800-0x19FF	0x00000180 + node address
B	0x1800-0x19FF	0x80000380 + node address
C	0x1800-0x19FF	0x80000000
D	0x1800-0x19FF	0x80000000

11.8.3 TxPDO transmission type

Index	0x1800-0x19FF	Sub-index	2
Data type	UNSIGNED8	Access	RW

The transmission type defines when the TxPDO data is read from the source parameters and when it is transmitted over the SI-CANopen network. SI-CANopen supports all CANopen transmission modes.

Table 11.16 Supported TxPDO transmission types

Transmission type	Timing	Description
0	Acyclic, synchronous	The source data is read when the SYNC message is received. If the source data has changed, the TxPDO is transmitted.
1 - 240	Cyclic, synchronous	The source data is read and the TxPDO is transmitted every n SYNC messages, where n = transmission type.
252	Synchronous, RTR only	The source data is read when the SYNC message is received, but the TxPDO will only be transmitted when an RTR message is received. The RTR message must have the correct COB-ID for the required TxPDO.
253	Asynchronous, RTR only	The source data is read and the TxPDO is transmitted when an RTR message is received. The RTR message must have the correct COB-ID for the required TxPDO.
254	Asynchronous, event trigger	The source data is read and the TxPDO is transmitted in response to 2 events: 1. An OFF-to-ON (0-to-1) transition in Pr S.MM.012 (where MM = 2, 3, 4 or 5). Pr S.MM.012 (where MM = 2, 3, 4 or 5) must be reset to OFF for a minimum of 1 ms to allow the TxPDO to be transmitted on the next OFF-ON transition. This allows the TxPDO to be controlled by a digital input. 2. Event timer. Refer to Figure 11.8.5 <i>TxPDO event timer</i> on page 74 for more details.
255	Asynchronous timer trigger / Acyclic	In SI-CANopen versions earlier than V03.02.05 the source data is read and the TxPDO is transmitted in response to the event timer. In SI-CANopen versions V03.02.05 (or later) the TxPDO will be transmitted depending on the value in 0x2832 (see <i>section 11.8.6 TxPDO profile specific mode</i> on page 75 for more information).

If a TxPDO has transmission type 0 to 240, 254 or 255, the SI-CANopen master controller can use an RTR message (with the COB-ID of the required PDO) to get the SI-CANopen to re-transmit the required TxPDO. SI-CANopen does NOT update the data values for the requested TxPDO; data update will only occur when specified for the TxPDO transmission type.

If a TxPDO is configured with transmission type 252 or 253, it can only be transmitted in response to an RTR message from the SI-CANopen master controller.

Default values for the TxPDO transmission types are shown in Table 11.17.

Table 11.17 TxPDO transmission type default values

TxPDO	Index	Default	Comment
A (default = 1)	0x1800-0x19FF	255	Specified in Pr S.02.003 /SDO configuration
B (default = 3)	0x1800-0x19FF	255	SDO configuration
C (default = 5)	0x1800-0x19FF	255	SDO configuration
D (default = 6)	0x1800-0x19FF	255	SDO configuration

NOTE The actual index number is calculated by subtracting 1 from the PDO number and adding this number to the base address e.g. for 0x1800 PDO3 = 0x1802.

11.8.4 TxPDO inhibit time

Index	0x1800-0x19FF	Sub-index	3	Access	RW
Default	0	Data type	USIGN16		

The TxPDO time inhibit time specifies the time period (in multiples of 100µs) of the minimum interval between PDO transmissions of the same PDO. The inhibit time defines the minimum time that has to elapse between two consecutive invocations of a PDOs service. This can be used to help limit traffic on the network.

11.8.5 TxPDO event timer

Index	0x1800-0x19FF	Sub-index	5	Access	RW
Default	0	Data type	USIGN16		

The TxPDO event timer specifies the time period (in ms) between transmission of TxPDOs with transmission type 254 or 255 (see *section 11.17 TxPDO transmission type default values* on page 74). Set the TxPDO event timer to 0 to disable the event timer.

11.8.6 TxPDO profile specific mode

Index	0x2832	Sub-index	0	Access	RW
TxPDO profile specific mode		Data type	BYTE	Default	0

If a TxPDO is configured with a transmission type of 225 the TxPDO will be transmitted dependant on the values detailed in Table 11.18 below. In versions earlier than V03.02.05, TxPDOs with transmission type 255 can only be transmitted in response to the event timer.

Table 11.18 Supported TxPDO Transmission type 255 modes

Value	Mode	Description
0	Timed	PDO will be transmitted each time the event timer expires.
1	Change OR Timed	PDO will be transmitted when data has changed unless an event timer is specified.
2	Change AND Timed	PDO will be transmitted when mapped data values change as well as each time the event timer expires.

NOTE The actual index number is calculated by subtracting 1 from the PDO number and adding this number to the base address e.g. for 0x1800 PDO3 = 0x1802.

11.9 TxPDO mapping parameters

The source parameters for data transmitted on a TxPDO are specified in the TxPDO mapping parameters. Four mapping parameters are provided for each TxPDO, allowing data to be mapped to all drive and SI-Applications parameters. TxPDO data can also be mapped to all SI-CANopen object dictionary entries that allow PDO mapping.

The default mappings for TxPDOA are derived from the mapping parameters (Pr **S.02.015** to Pr **S.02.018**) during initialization and configured via the menu, therefore changes made via these parameters will require a reset in order to take effect. However, the mappings for all four TxPDOs can be changed via the appropriate CANopen object dictionary mapping objects (using SDO communications), changes made via this method will take effect immediately.

NOTE The SI-CANopen will NOT update the drive mapping parameters if the CANopen object dictionary mapping parameters are changed after the SI-CANopen has initialised. This means that the SI-CANopen will revert to the drive parameter-defined mappings during the next initialization.

Table 11.19 TxPDO mapping parameters

Index	Sub-index	Description	Data type	Access
0x1A00-0x1BFF	0	Number of mapped objects in TxPDO	UNSIGNED8	RW
0x1A00-0x1BFF	1	Channel 0 mapping	UNSIGNED32	RW*
0x1A00-0x1BFF	2	Channel 1 mapping	UNSIGNED32	RW*
0x1A00-0x1BFF	3	Channel 2 mapping	UNSIGNED32	RW*
0x1A00-0x1BFF	4	Channel 3 mapping	UNSIGNED32	RW*

NOTE * - read/write only if the number of mapped application objects in TxPDO (index 0x1A00 sub-index 0) is set to 0. Refer to section 7.4 *Changing PDO mapping parameters (via controller/PLC)* on page 53.

NOTE The actual index number is calculated by subtracting 1 from the PDO number and adding this number to the base address e.g. for 0x1600 PDO3 = 0x1602.

The default mappings for RxPDO1 are shown in Table 11.20. RxPDO1 is enabled by default. The default configuration for SI-CANopen is RxPDOs 1, 3, 5 & 6 and TxPDOs 1, 3, 5 & 6, this however may be changed using objects 0x2800 and 0x2801 (*section 11.5.1 RxPDO number configuration on page 68*). The destination parameters for data received from an RxPDO are specified in the RxPDO mapping parameters.

Four mapping parameters are provided for each RxPDO, allowing data to be mapped to all drive and SI-Applications parameters. RxPDO data can also be mapped to all SI-LCANopen object dictionary entries that allow PDO mapping.

Table 11.20 TxPDOA (by default TxPDO 1)

Index	Sub-index	Description	Default	Mapping destination
0x1A00	0	Number of entries	2	N/A
0x1A00	1	Channel 0 mapping	0x200A2820	Pr 10.040
0x1A00	2	Channel 1 mapping	0x20020120	Pr 02.001
0x1A00	3	Channel 2 mapping	0x00000000	Not used with default mappings
0x1A00	4	Channel 3 mapping	0x00000000	

Profile position mode is not supported in the SI-CANopen, but TxPDO3 is provided for use with a user program profile implementation. By default, all TxPDO3 mappings are set to 0.

NOTE The actual index number is calculated by subtracting 1 from the PDO number and adding this number to the base address e.g. for 0x1600 PDO3 = 0x1602.

Table 11.21 TxPDOB (by default TxPDO 3)

Index	Sub-index	Description	Default	Mapping destination
0x1A02	0	Number of entries	2	N/A
0x1A02	1	Channel 0 mapping	0x00000000	Not used with default mappings
0x1A02	2	Channel 1 mapping	0x00000000	
0x1A02	3	Channel 2 mapping	0x00000000	
0x1A02	4	Channel 3 mapping	0x00000000	

NOTE The actual index number is calculated by subtracting 1 from the PDO number and adding this number to the base address e.g. for 0x1600 PDO3 = 0x1602.

By default, TxPDO5 is disabled, so the mapping objects are all set to 0. When DSP402 profiles are enabled, the specified mappings for profile torque mode are shown in Table 11.22.

Table 11.22 TxPDO6 (by default TxPDO 5) default mapping

Index	Sub-index	Description	Default	Mapping destination
0x1A04	0	Number of entries	2	N/A
0x1A04	1	Channel 0 mapping	0x60410010	status word
0x1A04	2	Channel 1 mapping	0x60770010	torque_actual_value
0x1A04	3	Channel 2 mapping	0x00000000	Not used with default mappings
0x1A04	4	Channel 3 mapping	0x00000000	

NOTE The actual index number is calculated by subtracting 1 from the PDO number and adding this number to the base address e.g. for 0x1600 PDO3 = 0x1602.

By default, TxPDO6 is disabled, so the mapping objects are all set to 0. When DSP402 profiles are enabled, the specified mappings for velocity mode are shown in Table 11.23.

Table 11.23 TxPDO6 (by default TxPDO 6) default mapping

Index	Sub-index	Description	Default	Mapping destination
0x1A05	0	Number of entries	2	N/A
0x1A05	1	Channel 0 mapping	0x60410010	statusword
0x1A05	2	Channel 1 mapping	0x60440010	vl_control_effort
0x1A05	3	Channel 2 mapping	0x00000000	Not used with default mappings
0x1A05	4	Channel 3 mapping	0x00000000	

NOTE The actual index number is calculated by subtracting 1 from the PDO number and adding this number to the base address e.g. for 0x1600 PDO3 = 0x1602.

11.10 RxPDO, SYNC and missed heartbeat event handling

11.10.1 0x2820 - RxPDOA event configuration

This object defines the event that will occur following the reception of RxPDOA. All events defined by these objects will be carried out in the background task after the message has been processed, this means that depending on the modules loading and the configuration of PDOs the delay before handling may vary, however it will always be within one background task cycle of the module.

Index	0x2820	Sub-index	0	Access	RO
Maximum sub-index		Data type	UINT32	Default	5

Will return 5 when read, indicating the maximum sub-index of the object.

Index	0x2820	Sub-index	1	Access	RO
Count		Data type	UINT32	Default	0

The number of times RxPDOA has been received. This value will increment every time the event occurs and will rollover once the maximum value for a unsigned 32 bit integer has been exceeded.

Index	0x2820	Sub-index	2	Access	RW
Mode		Data type	UINT32	Default	0

When the RxPDOA event occurs the specified parameter in sub-index three will be manipulated depending on the specified mode value.

Value	Mode	Description
0	None	No parameter manipulation will occur.
1	Set	The specified parameter will be set to a value of 1.
2	Clear	The specified parameter will be set to a value of 0.
3	Toggle	The specified parameter will be read and if non-zero a value of 0 will be written, otherwise a value of 1 will be written.
4	Count	The value of the count sub-index will be written to the specified parameter in sub-index 3. The value will be masked to the parameter size.

Index	0x2820	Sub-index	3	Access	RW
Parameter		Data type	UINT32	Default	0

The value of the parameter used for modes 1 to 4 will be in the format:

$$(\text{Slot} \times 100,000) + (\text{Menu} \times 1000) + \text{Parameter}$$

A value of 0 will inhibit the operation.

Index	0x2820	Sub-index	4	Access	RW
Event task number		Data type	UINT32	Default	0

The SI-Applications event task to trigger following the RxPDOA event. The event task will always be triggered after any specified parameter manipulation has completed.

Value	Event task to trigger
0	None
1	Event
2	Event1
3	Event2
4	Event3

Index	0x2820	Sub-index	5	Access	RW
Event task slot		Data type	UINT32	Default	0

The option module slot where the event task should be triggered.

Value	Slot
0	Lowest slot
1	Slot 1
2	Slot 2
3	Slot 3

11.10.2 0x2821 - RxPDOB event configuration

This object defines the event that will occur following the reception of RxPDOB. All events defined by these objects will be carried out in the background task after the message has been processed, this means that depending on the modules loading and the configuration of PDOs the delay before handling may vary, however it will always be within one background task cycle of the SI-Applications module.

Index	0x2821	Sub-index	0	Access	RO
Maximum sub-index		Data type	UINT32	Default	5

Will return 5 when read, indicating the maximum sub-index of the object.

Index	0x2821	Sub-index	1	Access	RO
Count		Data type	UINT32	Default	0

The number of times RxPDOB has been received. This value will increment every time the event occurs and will rollover once the maximum value for a unsigned 32 bit integer has been exceeded.

Index	0x2821	Sub-index	2	Access	RW
Mode		Data type	UINT32	Default	0

When the RxPDOB event occurs the specified parameter in sub-index 3 will be manipulated depending on the specified mode value.

Value	Mode	Description
0	None	No parameter manipulation will occur.
1	Set	The specified parameter will be set to a value of 1.
2	Clear	The specified parameter will be set to a value of 0.
3	Toggle	The specified parameter will be read and if non-zero a value of 0 will be written, otherwise a value of 1 will be written.
4	Count	The value of the count sub-index will be written to the specified parameter in sub-index 3. The value will be masked to the parameter size.

Index	0x2821	Sub-index	3	Access	RW
Parameter		Data type	UINT32	Default	0

The parameter to use for modes 1-4, this value will be in the format (Slot x 100,000) + (Menu x 1000) + Parameter. A value of 0 will inhibit the operation.

Index	0x2821	Sub-index	4	Access	RW
Event task number		Data type	UINT32	Default	0

The SI-Applications event task to trigger following the RxPDOB event. The event task will always be triggered after any specified parameter manipulation has completed.

Table 11.24

Value	Event task to trigger
0	None
1	Event
2	Event1
3	Event2
4	Event3

Index	0x2821	Sub-index	5	Access	RW
Event task slot		Data type	UINT32	Default	0

The option module slot where the event task should be triggered.

Value	Slot
0	Lowest slot
1	Slot 1
2	Slot 2
3	Slot 3
4	Slot 4

11.10.3 0x2822 - RxPDOC event configuration

This object defines the event that will occur following the reception of RxPDOC. All events defined by these objects will be carried out in the background task after the message has been processed, this means that depending on the modules loading and the configuration of PDOs the delay before handling may vary, however it will always be within one background task cycle.

Index	0x2822	Sub-index	0	Access	RO
Maximum sub-index		Data type	UINT32	Default	0

Will return 5 when read, indicating the maximum sub-index of the object.

Index	0x2822	Sub-index	1	Access	RO
Count		Data type	UINT32	Default	0

The number of times RxPDOC has been received. This value will increment every time the event occurs, and will rollover once the maximum value for an unsigned 32 bit integer has been exceeded.

Index	0x2822	Sub-index	2	Access	RW
Mode		Data type	UINT32	Default	0

When the RxPDOC event occurs the specified parameter in sub-index 3 will be manipulated depending on the specified mode value.

Value	Mode	Description
0	None	No parameter manipulation will occur.
1	Set	The specified parameter will be set to a value of 1.
2	Clear	The specified parameter will be set to a value of 0.
3	Toggle	The specified parameter will be read and if non-zero a value of 0 will be written, otherwise a value of 1 will be written.
4	Count	The value of the count sub-index will be written to the specified parameter in sub-index 3. The value will be masked to the parameter size.

Index	0x2822	Sub-index	3	Access	RW
Parameter		Data type	UINT32	Default	0

The parameter to use for modes 1-4, this value will be in the format (Slot x 100,000) + (Menu x 1000) + Parameter. A value of 0 will inhibit the operation.

Index	0x2822	Sub-index	4	Access	RW
Event task number		Data type	UINT32	Default	0

The SI-Applications event task to trigger following the RxPDOC event. The event task will always be triggered after any specified parameter manipulation has completed.

Value	Event task to trigger
0	None
1	Event
2	Event1
3	Event2
4	Event3

Index	0x2822	Sub-index	5	Access	RW
Event task slot		Data type	UINT32	Default	0

The option module slot where the event task should be triggered.

Value	Slot
0	Lowest slot
1	Slot 1
2	Slot 2
3	Slot 3
4	Slot 4

The option module slot where the event task should be triggered.

11.10.4 0x2823 - RxPDOD event configuration

This object defines the event that will occur following the reception of RxPDOD. All events defined by these objects will be carried out in the background task after the message has been processed, this means that depending on the modules loading and the configuration of PDOs the delay before handling may vary, however it will always be within one background task cycle of the SI-Applications module.

Index	0x2823	Sub-index	0	Access	RO
Maximum sub-index		Data type	UINT32	Default	0

Will return 5 when read, indicating the maximum sub-index of the object.

Index	0x2823	Sub-index	1	Access	RO
Count		Data type	UINT32	Default	0

The number of times RxPDOD has been received. This value will increment every time the event occurs and will rollover once the maximum value for a unsigned 32 bit integer has been exceeded.

Index	0x2823	Sub-index	2	Access	RW
Mode		Data type	UINT32	Default	0

When the RxPDOD event occurs the specified parameter in sub-index 3 will be manipulated depending on the specified mode value.

Value	Mode	Description
0	None	No parameter manipulation will occur.
1	Set	The specified parameter will be set to a value of 1.
2	Clear	The specified parameter will be set to a value of 0.
3	Toggle	The specified parameter will be read and if non-zero a value of 0 will be written, otherwise a value of 1 will be written.
4	Count	The value of the count sub-index will be written to the specified parameter in sub-index 3. The value will be masked to the parameter size.

Index	0x2823	Sub-index	3	Access	RW
Parameter		Data type	UINT32	Default	0

The parameter to use for modes 1-4, this value will be in the format (Slot x 100,000) + (Menu x 1,000) + Parameter. A value of 0 will inhibit the operation.

Index	0x2823	Sub-index	4	Access	RW
Event task number		Data type	UINT32	Default	0

The SI-Applications event task to trigger following the RxPDOD event. The event task will always be triggered after any specified parameter manipulation has completed.

Value	Event task to trigger
0	None
1	Event
2	Event1
3	Event2
4	Event3

Index	0x2823	Sub-index	5	Access	RW
Event task slot		Data type	UINT32	Default	0

The option module slot where the event task should be triggered.

Value	Slot
0	Lowest slot
1	Slot 1
2	Slot 2
3	Slot 3
4	Slot 4

11.10.5 0x2830 - SYNC event configuration

This object defines the event that will occur following the reception of SYNC messages. All events defined by these objects will be carried out in the background task after the message has been processed, this means that depending on the modules loading and the configuration of PDOs the delay before handling may vary, however it will always be within one background task cycle of the SI-Applications module.

Index	0x2830	Sub-index	0	Access	RO
Maximum sub-index		Data type	UINT32	Default	5

Will return 5 when read, indicating the maximum sub-index of the object.

Index	0x2830	Sub-index	1	Access	RO
Count		Data type	UINT32	Default	0

The number of times the SYNC message has been received. This value will increment every time a SYNC message occurs and will rollover once the maximum value for a unsigned 32 bit integer has been exceeded.

Index	0x2830	Sub-index	2	Access	RW
Mode		Data type	UINT32	Default	0

When the SYNC message occurs the specified parameter in sub-index 3 will be manipulated depending on the specified mode value:

Value	Mode	Description
0	None	No parameter manipulation will occur.
1	Set	The specified parameter will be set to a value of 1.
2	Clear	The specified parameter will be set to a value of 0.
3	Toggle	The specified parameter will be read and if non-zero a value of 0 will be written, otherwise a value of 1 will be written.
4	Count	The value of the count sub-index will be written to the specified parameter in sub-index 3. The value will be masked to the parameter size.

Index	0x2830	Sub-index	3	Access	RW
Parameter		Data type	UINT32	Default	0

The parameter to use for modes 1-4, this value will be in the format (Slot x 100,000) + (Menu x 1,000) + Parameter. A value of 0 will inhibit the operation.

Index	0x2830	Sub-index	4	Access	RW
Event task number		Data type	UINT32	Default	0

The SI-Applications event task to trigger following a SYNC messages. The event task will always be triggered after any specified parameter manipulation has completed.

Value	Event task to trigger
0	None
1	Event
2	Event1
3	Event2
4	Event3

Index	0x2830	Sub-index	5	Access	RW
Event task slot		Data type	UINT32	Default	0

The option module slot where the event task should be triggered.

Value	Slot
0	Lowest slot
1	Slot 1
2	Slot 2
3	Slot 3
4	Slot 4

11.10.6 0x2831 - Missed heartbeat

This object defines the event that will occur following a missed heartbeat message. All events defined by these objects will be carried out in the background task of the SI-Applications module after the message has been processed, this means that depending on the modules loading and the configuration of PDOs the delay before handling may vary, however it will always be within one background task cycle.

Index	0x2831	Sub-index	0	Access	RO
Maximum sub-index		Data type	UINT32	Default	6

Will return 6 when read, indicating the maximum sub-index of the object.

Index	0x2831	Sub-index	1	Access	RO
Count		Data type	UINT32	Default	0

The number of times a missed heartbeat has occurred. This value will increment every time a missed heartbeat message occurs and will rollover once the maximum value for a unsigned 32 bit integer has been exceeded.

Index	0x2831	Sub-index	2	Access	RW
Mode		Data type	UINT32	Default	0

When a missed heartbeat occurs the specified parameter in sub-index 3 will be manipulated depending on the specified mode value.

Value	Mode	Description
0	None	No parameter manipulation will occur.
1	Set	The specified parameter will be set to a value of 1.
2	Clear	The specified parameter will be set to a value of 0.
3	Toggle	The specified parameter will be read and if non-zero a value of 0 will be written, otherwise a value of 1 will be written.
4	Count	The value of the count sub-index will be written to the specified parameter in sub-index 3. The value will be masked to the parameter size.

Index	0x2831	Sub-index	3	Access	RW
Parameter		Data type	UINT32	Default	0

The parameter to use for modes 1-4, this value will be in the format (Slot x 100,000) + (Menu x 1,000) + Parameter. A value of 0 will inhibit the operation.

Index	0x2831	Sub-index	4	Access	RW
Event task number		Data type	UINT32	Default	0

The SI-Applications event task to trigger following a missed heartbeat message. The event task will always be triggered after any specified parameter manipulation has completed.

Value	Event task to trigger
0	None
1	Event
2	Event1
3	Event2
4	Event3

Index	0x2831	Sub-index	5	Access	RW
Event task slot		Data type	UINT32	Default	0

The option module slot where the event task should be triggered.

Value	Slot
0	Lowest slot
1	Slot 1
2	Slot 2
3	Slot 3
4	Slot 4

Index	0x2831	Sub-index	6	Access	RW
Trip enable		Data type	UINT32	Default	0

Enable the trip associated with the event. When an event occurs that has a trip enable the drive will trip with a slot error displayed.

11.11 RxPDO event triggers

11.11.1 0x2840 - RxPDOA trigger configuration

This object will be used to configure an RxPDOA trigger.

Index	0x2840	Sub-index	0	Access	RO
Trip enable		Data type	UINT32	Default	2

Will return 2 when read, indicating the maximum sub-index of the object.

Index	0x2840	Sub-index	1	Access	RO
Mode		Data type	UINT32	Default	1

When the RxPDOA trigger occurs the specified parameter will be manipulated depending on the specified mode value:

Value	Mode	Description
0	None	No triggering will occur.
1	Non-zero	The event will be triggered when the specified parameter changes from 0 to any non-zero value. It must be set back to 0 to re-arm the trigger.
2	Reset	The event will be triggered when the specified parameter changes from 0 to any non-zero value. The parameter will then automatically be set back to 0.
3	Change	The event will be triggered any time the specified parameter changes value.

If a read-only parameter is currently set then the mode cannot be set to Reset. The mode is defaulted to Non-zero for backward compatibility.

Index	0x2840	Sub-index	2	Access	RO
Trigger Parameter		Data type	UINT32	Default	6036

The event trigger parameter for the RxPDOA when its transmission type is set to 254 (asynchronous, event trigger) will be in the format (Slot x 100,000) + (Menu x 1,000) + Parameter. A value of 0 will inhibit the operation.

If the Reset mode is selected a read-only parameter cannot be set. The parameter is defaulted to Pr **S.02.012** for backward compatibility.

11.11.2 0x2841 - RxPDOB trigger configuration

This object will be used to configure an RxPDOB trigger.

Index	0x2841	Sub-index	0	Access	RO
Maximum sub-index		Data type	UINT32	Default	2

Will return 2 when read, indicating the maximum sub-index of the object.

Index	0x2841	Sub-index	1	Access	RO
Mode		Data type	UINT32	Default	1

When the RxPDOB trigger occurs the specified parameter will be manipulated depending on the specified mode value:

Value	Mode	Description
0	None	No triggering will occur.
1	Non-zero	The event will be triggered when the specified parameter changes from 0 to any non-zero value. It must be set back to 0 to re-arm the trigger.
2	Reset	The event will be triggered when the specified parameter changes from 0 to any non-zero value. The parameter will then automatically be set back to 0.
3	Change	The event will be triggered any time the specified parameter changes value.

If a read-only parameter is currently set then the mode cannot be set to Reset. The mode is defaulted to Non-zero for backward compatibility.

Index	0x2841	Sub-index	2	Access	RO
Trigger Parameter		Data type	UINT32	Default	6036

The event trigger parameter for the RxPDOB when its transmission type is set to 254 (asynchronous, event trigger) will be in the format (Slot x 100,000) + (Menu x 1,000) + Parameter. A value of 0 will inhibit the operation.

If the Reset mode is selected a read-only parameter cannot be set. The parameter is defaulted to Pr **MM.36** for backward compatibility.

11.11.3 0x2842 - RxPDO trigger configuration

This object will be used to configure an RxPDO trigger.

Index	0x2842	Sub-index	0	Access	RO
Maximum sub-index		Data type	UINT32	Default	2

Will return 2 when read, indicating the maximum sub-index of the object.

Index	0x2842	Sub-index	1	Access	RO
Mode		Data type	UINT32	Default	1

When the RxPDO trigger occurs the specified parameter will be manipulated depending on the specified mode value:

Value	Mode	Description
0	None	No triggering will occur.
1	Non-zero	The event will be triggered when the specified parameter changes from 0 to any non-zero value. It must be set back to 0 to re-arm the trigger.
2	Reset	The event will be triggered when the specified parameter changes from 0 to any non-zero value. The parameter will then automatically be set back to 0.
3	Change	The event will be triggered any time the specified parameter changes value.

If a read-only parameter is currently set then the mode cannot be set to Reset. The mode is defaulted to Non-zero for backward compatibility.

Index	0x2842	Sub-index	2	Access	RO
Trigger Parameter		Data type	UINT32	Default	6036

The event trigger parameter for the RxPDO when its transmission type is set to 254 (asynchronous, event trigger) will be in the format (Slot x 100,000) + (Menu x 1,000) + Parameter. A value of 0 will inhibit the operation.

If the Reset mode is selected a read-only parameter cannot be set. The parameter is defaulted to Pr **S.04.012** for backward compatibility.

11.11.4 0x2843 - RxPDOD trigger configuration

This object will be used to configure an RxPDOD trigger.

Index	0x2843	Sub-index	0	Access	RO
Maximum sub-index		Data type	UINT32	Default	2

Will return 2 when read, indicating the maximum sub-index of the object.

Index	0x2843	Sub-index	1	Access	RO
Mode		Data type	UINT32	Default	1

When the RxPDOD trigger occurs the specified parameter will be manipulated depending on the specified mode value:

Value	Mode	Description
0	None	No triggering will occur.
1	Non-zero	The event will be triggered when the specified parameter changes from 0 to any non-zero value. It must be set back to 0 to re-arm the trigger.
2	Reset	The event will be triggered when the specified parameter changes from 0 to any non-zero value. The parameter will then automatically be set back to 0.
3	Change	The event will be triggered any time the specified parameter changes value.

If a read-only parameter is currently set then the mode cannot be set to reset. The mode is defaulted to non-zero for backward compatibility.

Index	0x2843	Sub-index	2	Access	RO
Trigger Parameter		Data type	UINT32	Default	6036

The event trigger parameter for the RxPDOD when its transmission type is set to 254 (asynchronous, event trigger) will be in the format (Slot x 100,000) + (Menu x 1,000) + Parameter. A value of 0 will inhibit the operation.

If the reset mode is selected a read-only parameter cannot be set. The parameter is defaulted to Pr **S.05.012** for backward compatibility.

11.12 TxPDO event triggers

11.12.1 0x2850 - TxPDOA trigger configuration

This object will be used to configure an TxPDOA trigger.

Index	0x2850	Sub-index	0	Access	RO
Maximum sub-index		Data type	UINT32	Default	2

Will return 2 when read, indicating the maximum sub-index of the object.

Index	0x2850	Sub-index	1	Access	RO
Mode		Data type	UINT32	Default	1

When the TxPDOA trigger occurs the specified parameter will be manipulated depending on the specified mode value:

Value	Mode	Description
0	None	No triggering will occur.
1	Non-zero	The event will be triggered when the specified parameter changes from 0 to any non-zero value. It must be set back to 0 to re-arm the trigger.
2	Reset	The event will be triggered when the specified parameter changes from 0 to any non-zero value. The parameter will then automatically be set back to 0.
3	Change	The event will be triggered any time the specified parameter changes value.

If a read-only parameter is currently set then the mode cannot be set to reset. The mode is defaulted to Non-zero for backward compatibility.

Index	0x2850	Sub-index	2	Access	RO
Trigger parameter		Data type	UINT32	Default	6036

The event trigger parameter for the TxPDOA when its transmission type is set to 254 (asynchronous, event trigger) will be in the format (Slot x 100,000) + (Menu x 1,000) + Parameter. A value of 0 will inhibit the operation.

If the reset mode is selected a read-only parameter cannot be set. The parameter is defaulted to Pr **S.02.012** for backward compatibility.

11.12.2 0x2851 - TxPDOB trigger configuration

This object will be used to configure an TxPDOB trigger.

Index	0x2851	Sub-index	0	Access	RO
Maximum sub-index		Data type	UINT32	Default	2

Will return 2 when read, indicating the maximum sub-index of the object.

Index	0x2851	Sub-index	1	Access	RO
Mode		Data type	UINT32	Default	1

When the TxPDOB trigger occurs the specified parameter will be manipulated depending on the specified mode value:

Value	Mode	Description
0	None	No triggering will occur.
1	Non-zero	The event will be triggered when the specified parameter changes from 0 to any non-zero value. It must be set back to 0 to re-arm the trigger.
2	Reset	The event will be triggered when the specified parameter changes from 0 to any non-zero value. The parameter will then automatically be set back to 0.
3	Change	The event will be triggered any time the specified parameter changes value.

If a read-only parameter is currently set then the mode cannot be set to reset. The mode is defaulted to non-zero for backward compatibility.

Index	0x2851	Sub-index	2	Access	RO
Trigger parameter		Data type	UINT32	Default	6036

The event trigger parameter for the TxPDOB when its transmission type is set to 254 (asynchronous, event trigger) will be in the format (Slot x 100,000) + (Menu x 1,000) + Parameter. A value of 0 will inhibit the operation.

If the reset mode is selected a read-only parameter cannot be set. The parameter is defaulted to Pr **S.03.012** for backward compatibility.

11.12.3 0x2852 - TxPDO trigger configuration

This object will be used to configure an TxPDO trigger.

Index	0x2852	Sub-index	0	Access	RO
Maximum sub-index		Data type	UINT32	Default	2

Will return 2 when read, indicating the maximum sub-index of the object.

Index	0x2852	Sub-index	1	Access	RO
Mode		Data type	UINT32	Default	1

When the TxPDO trigger occurs the specified parameter will be manipulated depending on the specified mode value:

Value	Mode	Description
0	None	No triggering will occur.
1	Non-zero	The event will be triggered when the specified parameter changes from 0 to any non-zero value. It must be set back to 0 to re-arm the trigger.
2	Reset	The event will be triggered when the specified parameter changes from 0 to any non-zero value. The parameter will then automatically be set back to 0.
3	Change	The event will be triggered any time the specified parameter changes value.

If a read-only parameter is currently set then the mode cannot be set to reset. The mode is defaulted to Non-zero for backward compatibility.

Index	0x2852	Sub-index	2	Access	RO
Trigger parameter		Data type	UINT32	Default	6036

The event trigger parameter for the TxPDO when its transmission type is set to 254 (asynchronous, event trigger) will be in the format (Slot x 100,000) + (Menu x 1,000) + Parameter. A value of 0 will inhibit the operation.

If the reset mode is selected a read-only parameter cannot be set. The parameter is defaulted to Pr **S.04.012** for backward compatibility.

11.12.4 0x2853 - TxPDOD trigger configuration

This object will be used to configure an TxPDOD trigger.

Index	0x2853	Sub-index	0	Access	RO
Maximum sub-index		Data type	UINT32	Default	2

Will return 2 when read, indicating the maximum sub-index of the object.

Index	0x2853	Sub-index	1	Access	RO
Mode		Data type	UINT32	Default	1

When the TxPDOD trigger occurs the specified parameter will be manipulated depending on the specified mode value:

Value	Mode	Description
0	None	No triggering will occur.
1	Non-zero	The event will be triggered when the specified parameter changes from 0 to any non-zero value. It must be set back to 0 to re-arm the trigger.
2	Reset	The event will be triggered when the specified parameter changes from 0 to any non-zero value. The parameter will then automatically be set back to 0.
3	Change	The event will be triggered any time the specified parameter changes value.

If a read-only parameter is currently set then the mode cannot be set to reset. The mode is defaulted to non-zero for backward compatibility.

Index	0x2853	Sub-index	2	Access	RO
Trigger parameter		Data type	UINT32	Default	6036

The event trigger parameter for the TxPDOD when its transmission type is set to 254 (asynchronous, event trigger) will be in the format: (Slot x 100,000) + (Menu x 1,000) + Parameter. A value of 0 will inhibit the operation.

If the Reset mode is selected a read-only parameter cannot be set. The parameter is defaulted to Pr **S.05.012** for backward compatibility.

11.13 Network management objects (NMT)

SI-CANopen uses the standard SI-CANopen network management state machine to determine the behavior of the communication objects. Figure 11-1 shows the NMT state machine, and the different state transitions that are possible.

Figure 11-1 NMT state machine

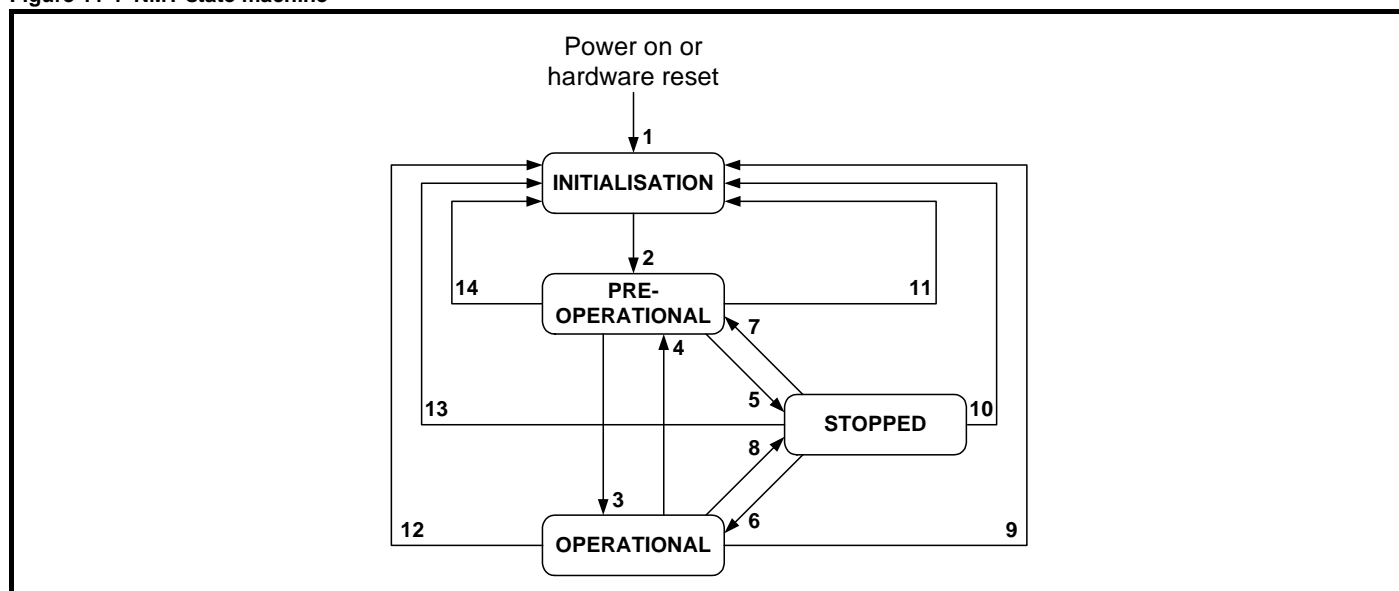

Table 11.25 NMT state machine transitions

Transition	Transition initiated by
1	At power on or hardware reset, enter INITIALISATION automatically
2	INITIALISATION complete, enter PRE-OPERATIONAL automatically
3, 6	START_REMOTE_NODE
4, 7	ENTER_PRE_OPERATIONAL
5, 8	STOP_REMOTE_NODE
9, 10, 11	RESET_NODE
12, 13, 14	RESET_COMMUNICATION

11.13.1 NMT states

SI-CANopen has various different communication objects, but some objects are only active in certain NMT states. Table 11.26 lists the communication objects supported by SI-CANopen, and the NMT states in which each object is active.

Table 11.26 NMT states and active messages

Object	INITIALISATION	PRE-OPERATIONAL	OPERATIONAL	STOPPED
PDO	-	-	Active	-
SDO	-	Active	Active	-
SYNC	-	Active	Active	-
Emergency	-	Active	Active	-
Boot-up	Active	-	-	-
NMT		Active	Active	Active

11.13.2 Initialization

SI-CANopen may be switched into **Initialization** from any other state using the RESET_NODE or RESET_COMMUNICATION commands.

11.13.3 Pre-operational

The synchronization object, emergency object, NMT objects and SDO communications are all active in the PRE-OPERATIONAL state, allowing device configuration to take place. PDOs do not exist in the PRE-OPERATIONAL state and are inactive. This allows PDO configuration and mapping objects to be configured without interfering with active communications.

SI-CANopen may be switched into PRE-OPERATIONAL from OPERATIONAL (transition 4) or STOPPED (transition 7) using the ENTER_PRE-OPERATIONAL command.

11.13.4 Operational

All communication objects are active in the OPERATIONAL state. All configured PDOs are created when SI-CANopen enters the OPERATIONAL state, using the parameter values in the object dictionary. SDO communications remain active in the OPERATIONAL state.

SI-CANopen may be switched into OPERATIONAL from PRE-OPERATIONAL (transition 3) or STOPPED (transition 6) using the START_REMOTE_NODE command.

11.13.5 Stopped

All communications (except NMT and heartbeat) are stopped when the SI-CANopen is switched into the STOPPED state. SI-CANopen will only respond to NMT messages while in the STOPPED state, so it must be switched into the PRE-OPERATIONAL or OPERATIONAL state to re-start communications. The heartbeat error control protocol remains active during the STOPPED state.

SI-CANopen may be switched into STOPPED from PRE-OPERATIONAL (transition 5) or OPERATIONAL (transition 8) using the STOP_REMOTE_NODE command.

11.14 NMT commands

Network Management (NMT) commands are low-level SI-CANopen commands that are used to switch SI-CANopen between the different NMT states. NMT messages always have a CAN identifier of 0x000 and contain 2 data bytes.

Table 11.27 NMT message structure

CAN identifier	Command (See Table 11.28)	Node ID
0x000	See Table 11.28	Target node

Table 11.28 NMT commands

Command	Code
START_REMOTE_NODE	1
STOP_REMOTE_NODE	2
ENTER_PRE_OPERATIONAL	128
RESET_NODE	129
RESET_COMMUNICATION	130

11.15 Layer setting services (LSS)

CANopen supports the complete SI-CANopen Layer Setting Service protocol, as defined in DSP205 V1.1. LSS provides the ability for a CANopen device with LSS Master capabilities to enquire and change the settings of certain parameters of the local layers on a LSS Slave CANopen device via the CAN network.

The following parameters can be enquired and/or changed by the use of LSS:

- Node-ID of the CANopen slave
- Bit timing parameters of the physical layer (baud rate)
- LSS address (Identity Object, Index 0x1018). The LSS address consists of Vendor ID, Product Code, Revision Number and Serial Number, and is unique to every SI-CANopen.

11.15.1 Enabling LSS

LSS functionality is enabled automatically if SI-CANopen initializes without an active node address, or when an NMT Stop command is issued. In default configuration,

SI-CANopen will have LSS enabled. There is no NMT functionality when LSS is active.

When LSS is active, all SI-CANopen devices will receive LSS commands on COB-ID 2021 (0x07E5) and respond on COB-ID 2020 (0x07E4). All LSS messages are 8 bytes long.

11.15.2 Configuring SI-CANopen via LSS

When SI-CANopen enters LSS mode, it is in an “operational” state, and no configuration can take place. SI-CANopen must be switched into “configuration” by:

1. addressing an SI-CANopen using its complete (and unique) LSS address.
2. switching all LSS devices into the “configuration” state.

Switching “all” devices into the “configuration” state should only be used when there is a single node on the network in LSS mode, or a bit timing change is required. This can be used for adding a single node at a time to the network without knowing its LSS address, configuring and activating it before adding another new device.

11.15.3 Switch mode global

The switch mode global command is used to change the LSS state of all nodes currently in LSS.

Table 11.29 Global Modes

COB-ID	Byte		
	0	1	2 - 7
0x7E5	0x04	Mode	Reserved (set to 0)

Mode 0 - switches all devices into "operational" mode.

Mode 1 - switches all devices into "configuration" mode.

If a device has a node address, the switch mode global command to "operational" will cause the device to re-initialise and activate with the new settings.

11.15.4 Switch mode selective

The switch mode selective commands are used to change a single device into the "configuration" state. A series of four commands are issued containing the four values of the LSS address. If all four values match the local values, and are received in the correct sequence, SI-CANopen will enter the "configuration" state and respond with a message to indicate that is now in this state.

All parts of the LSS address are obtained from the identity object (0x1018).

11.15.5 Select vendor ID

Command to specify the Vendor ID of the target SI-CANopen.

Table 11.30 Vendor ID

COB-ID	Byte		
	0	1 - 4	5 - 7
0x7E5	0x40	Vendor ID	Reserved (set to 0)

11.15.6 Select product code

Command to specify the Product Code of the target SI-CANopen.

Table 11.31 Product Code

COB-ID	Byte		
	0	1 - 4	5 - 7
0x7E5	0x41	Product Code	Reserved (set to 0)

11.15.7 Select revision number

Command to specify the Revision Number of the target SI-CANopen.

Table 11.32 Revision Number

COB-ID	Byte		
	0	1 - 4	5 - 7
0x7E5	0x42	Revision Number	Reserved (set to 0)

11.15.8 Select serial number

Command to specify the Serial Number of the target SI-CANopen.

Table 11.33 Serial Number specification

COB-ID	Byte		
	0	1 - 4	5 - 7
0x7E5	0x43	Serial Number	Reserved (set to 0)

11.15.9 Response

When a device has been identified, it will respond to acknowledge the mode change.

Table 11.34

COB-ID	Byte	
	0	1 - 7
0x7E4	0x44	Reserved (set to 0)

11.15.10 Configure node-ID

Configure Node-ID is used to assign a new node address to the device currently in “configuration” state. For SI-CANopen, the new node address will be written to Pr **S.01.004**. Once a device has a configured node ID, it will reset and start up using the new address when it is next switched in “operational” state.

Table 11.35 Node configuration

COB-ID	Byte		
	0	1	2 - 7
0x7E5	0x11	Node ID	Reserved (set to 0)

The device will respond to acknowledge the new node-ID.

Table 11.36 Node-ID acknowledgement

COB-ID	Byte			
	0	1 (see table 12.50)	2	3 - 7
0x7E4	0x11	Error code	Spec error	Reserved (set to 0)

Table 11.37 Error Types

Error Type	Byte	Description
Error code	0	Node-ID accepted
Error code	1	Node-ID out of range
Spec error	0	Always 0

11.15.11 Changing data rate

LSS allows the network data rate to be changed safely without any bus-off errors occurring. Every device node on the network must be in the “configuration” state. LSS protocol specifies a delay period before and after the data rate change during which devices are not allowed to place any message on the CAN network. This ensures that every node is able to change data rate safely without causing bus-off errors.

11.15.12 Configure bit timing

This is used to set a new value for the data rate. When a new data rate is specified

SI-CANopen will update Pr **S.01.007**, but the new setting will not take effect until the communications are re-initialized, or *Activate Bit Timings* command is issued.

Table 11.38 Configure bit timing

COB-ID	Byte			
	0	1	2	3 - 7
0x7E5	0x13	Table sel	Table ind	Reserved (set to 0)

Table sel 0 = standard CiA bit timings.

Table ind 0 to 8 = standard data rate settings. Refer to section 6.3 *Menu 1 - SI-CANopen Setup* (Pr **S.01.005**).

The devices will respond to acknowledge receipt of the new bit timings.

Table 11.39 Bit acknowledgement

COB-ID	Byte			
	0	1	2	3 - 7
0x7E4	0x13	Err code	Spec error	Reserved (set to 0)

Err code 0 = bit timing accepted.

Err code 1 = bit timing not supported.

Spec error = always 0.

11.15.13 Activate bit timing

This command tells all devices to change to the new data rate. If any of the devices have different data rate settings, or are not in “Configuration”, a conflict will occur and a bus-off error may occur. The switch delay time is specified in milliseconds, and specifies the idle time before and after the data rate change during which no devices are allowed to communicate on the network.

Table 11.40 Bit activation

COB-ID	Byte		
	0	1 - 2	3 - 7
0x7E5	0x15	Switch delay	Reserved (set to 0)

11.15.14 Store configuration

The store configuration command will force all drive parameters to be saved, provided the drive is not in a tripped state.

Table 11.41 Store configuration

COB-ID	Byte	
	0	1 - 7
0x7E5	0x17	Reserved (set to 0)

SI-CANopen will respond to acknowledge the save request.

Table 11.42 Configuration acknowledgement

COB-ID	Byte			
	0	1	2	3 - 7
0x7E4	0x17	Err code	Spec error	Reserved (set to 0)

Err code 0 = parameters saved.

Err code 1 = drive tripped, parameters were not saved.

Spec error = always 0.

11.15.15 Inquire Service

The Inquire Service command can be used to receive information about a device that is in the "configuration" state. Only one device may be in this state when this command is used.

If new devices are added to the SI-CANopen network one at a time, their default mode will be LSS. By using the Switch Mode Global and Inquire Service commands, the master can retrieve the information that is needed for addressing each device before configuring it and switching it out of LSS.

11.15.16 Inquire vendor ID

Request message:

Table 11.43 Request message

COB-ID	Byte	
	0	1 - 7
0x7E5	0x5A	Reserved (set to 0)

Response message:

Table 11.44 Response message

COB-ID	Byte		
	0	1 - 4	5 - 7
0x7E4	0x5A	Vendor ID	Reserved (set to 0)

11.15.17 Inquire product code

Request message:

Table 11.45 Request message

COB-ID	Byte	
	0	1 - 7
0x7E5	0x5B	Reserved (set to 0)

Response message:

Table 11.46 Response message

COB-ID	Byte		
	0	1 - 4	5 - 7
0x7E4	0x5B	Product Code	Reserved (set to 0)

11.15.18 Inquire revision number

Request message:

Table 11.47 Request message

COB-ID	Byte	
	0	1 - 7
0x7E5	0x5C	Reserved (set to 0)

Response message:

Table 11.48 Response message

COB-ID	Byte		
	0	1 - 4	5 - 7
0x7E4	0x40	Revision Number	Reserved (set to 0)

11.15.19 Inquire serial number

Request message:

Table 11.49 Request message

COB-ID	Byte	
	0	1 - 7
0x7E5	0x5D	Reserved (set to 0)

Response message

Table 11.50 Response message

COB-ID	Byte		
	0	1 - 4	5 - 7
0x7E4	0x40	Serial Number	Reserved (set to 0)

11.15.20 Inquire node-ID

Request message:

Table 11.51 Request message

COB-ID	Byte	
	0	1 - 7
0x7E5	0x5A	Reserved (set to 0)

Response message:

Table 11.52 Response message

COB-ID	Byte			
	0	1	2	3
COB-ID EMCY (Index 0x1014)	Emergency error code (See Table 12.63)		Error register (Index 0x1001)	Drive trip code
	4	5	6	7
	SI-CANopen Error code (Pr MM.50)	Manufacturer specific byte (0x1001, sub 0)	Manufacturer specific bytes (0x1001, sub 1)	

11.16 Emergency object

11.16.1 What is the emergency object?

Emergency objects are transmitted by the SI-CANopen when it detects that the drive has tripped. They are high priority messages that inform the CANopen master controller that some sort of error has occurred. It is up to the CANopen master controller to take appropriate action.

Emergency objects are suitable for interrupt-type error alerts. An emergency object is transmitted only once per error event and provided that no new errors occur, no further emergency objects will be transmitted.

11.16.2 Emergency object format

The emergency object consists of a total of eight data bytes. The first 3 bytes are defined by the CANopen specification, and the remaining five bytes are manufacturer-specific.

SI-CANopen will return the drive trip code and the SI-CANopen error code, allowing the CANopen master controller to determine exactly what fault has occurred.

Bytes 5 to 7 are always transmitted, but will always be set to 0.

Table 11.53 Emergency object format

COB-ID	Byte			
	0	1	2	3
COB-ID EMCY (Index 0x1014)	Emergency error code (See Table 11.54)		Error register (Index 0x1001)	Drive trip code
				CANopen error

The CANopen specification defines a list of standard error codes. Supported CANopen emergency error codes (and the drive trips that will produce the emergency error code) are listed in Table 11.54. All other drive trips will produce the generic error code, 0x1000.

Table 11.54 Emergency error codes

Error Code	Drive Trip Code	Description
0x0000	0 - No trip	Error reset or no error
0x1000	(Any trip code not elsewhere in table)	Generic error
0x2300	3 - OI.AC 4 - OI.br 20 - It.AC 92 - OI Snubber 98 - Out Phase Loss 109 - OI dc	Current, CANopen device output side - generic
0x3100	32 - PH	Mains voltage - generic
0x3200	2 - OU 5 - PS 9 - PS.24 V	Voltage inside the CANopen device - generic
0x4200	21 - Oht Inverter 22 - Oht Power 23 - Oht Control 27 - Oht dc bus 19 - Brake R Too Hot 93 - Inductor Too hot 101 - Oht Brake 102 - Oht Rectifier	Device temperature - generic
0x5000	200 - Slot1 HF 205 - Slot2 HF 210 - Slot3 HF 220 - 226 250 - Slot4 HF	CANopen device hardware - generic error
0x6100	227 - Sub-array RAM	Internal software - generic
0x6200	96 - User Prog Trip 249 - User Program	User software - generic

For full details about each trip, refer to the drive documentation.

11.17 Emergency object state

The SI-CANopen may be in one of two emergency states, as shown in Figure 11-2.

Figure 11-2 Emergency object states

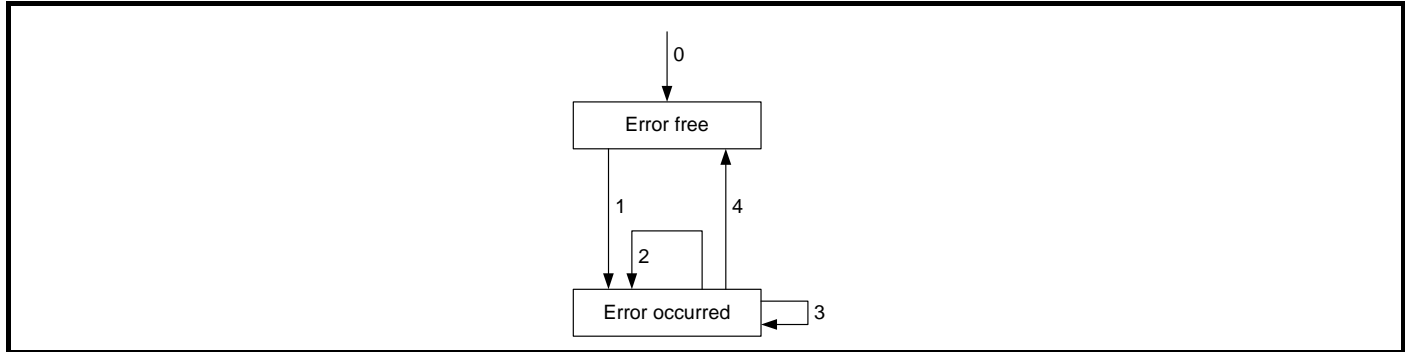

Table 11.55 Emergency object state transitions

Transition	Reference	Description
0	Initialization	After initialization, SI-CANopen enters the error free state if no error is detected. The emergency object is not transmitted.
1	Error occurred	SI-CANopen detects an error, transmits the emergency object once, and enters the error state.
2	Reset, new error occurred	One error (but not all errors) have been cleared. SI-CANopen will transmit another emergency object with information about the remaining error.
3	New error occurred	SI-CANopen has detected a new error condition, while in the error state. SI-CANopen remains in error state and transmits another emergency object with the appropriate error codes.
4	Reset, error cleared	All errors have been cleared. SI-CANopen will return to the error free state, and transmit an emergency object with the emergency error code set to 0x0000.

11.17.1 Error register

The error register is used by the SI-CANopen to indicate that an error has occurred, and can be mapped to TxPDOs if required. If a bit is set to 1, the specified error has occurred.

Table 11.56 Error register

Bit	Error	Description
0	Generic error	Set if any other bits in the register are set.
1	Current	Set if current errors occur.
2	Voltage	When drive detects a UU error.
3	Temperature	Set if temperature errors occur.
4	Reserved	Always set to 0
5	Reserved	
6	Reserved	
7	Manufacturer specific	Set if Pr 10.019 is set.

11.18 Device profiles

Basic implementations of two DSP402 device profiles (profile torque and velocity) have been included in the SI-CANopen, and supported objects are detailed in this section. Additional features may be implemented in an SI-Applications DPL program (where supported).

11.18.1 Conversion factors

The velocity mode profile specifies velocity parameters in rpm or percent, time parameters in seconds, and ramps in rpm/second. The drive uses different units for the different types of parameter, so conversion factors must be used.

Hz/rpm functions

The Hz/rpm functions are used when the drive is in open loop mode, as all speed reference parameters within the drive have units of Hz. The number of motor pole pairs is read from the drive whenever these equations are used.

$$\text{Hz} = \text{rpm} \times \text{PolePairs} / 60$$

$$\text{rpm} = \text{Hz} \times 60 / \text{PolePairs}$$

Ramp conversion functions

The ramp conversion functions are used to convert between rpm/s (specified using DeltaSpeed and DeltaTime) and the ramp specification used by the drive.

In open loop and SE mode, drive ramp units are specified in s/100Hz.

$$\text{Secs} / 100\text{Hz} = \text{DeltaTime} \times (100 \times 6 / \text{PolePairs}) \times 100 / \text{DeltaSpeed}$$

In closed loop and servo modes, drive ramp units are specified in s/1000rpm.

$$\text{Secs} / 1000\text{rpm} = \text{DeltaTime} \times 1000 \times 1000 / \text{DeltaSpeed}$$

11.18.2 Parameter data object mapping

The **controlword** and **statusword** used by the device profile modes are not the standard drive control and status words. They are defined in CiA DSP-402 V1.1, "Device Profile for Drive and Motion Control".

11.18.3 Profile torque mode

When the profile torque mode is selected, RxPDO5 and TxPDO5 consist of two 16-bit words. The specified mappings for profile torque mode are shown in Table 11.57.

Table 11.57 PDO5 mapping

Data word	Mapped object	Mapping status
RxPDO5 Word 0	0x6040	controlword
RxPDO5 Word 1	0x6071	target_torque
TxPDO5 Word 0	0x6041	statusword
TxPDO5 Word 1	0x6077	torque_actual_value

11.18.4 Velocity mode

When the velocity mode profile is selected, RxPDO6 and TxPDO6 consists of two 16-bit words. The specified mappings for velocity mode are shown in Table 11.58.

Table 11.58 PDO6 mapping

Data word	Mapped object	Mapping status
RxPDO6 Word 0	0x6040	controlword
RxPDO6 Word 1	0x6042	vl_target_velocity
TxPDO6 Word 0	0x6041	statusword
TxPDO6 Word 1	0x6044	vl_control_effort

11.18.5 Common entries

The common objects may be used by all supported profiles.

Table 11.59 Supported common objects

Index	Object	Name	Type	Access	PDO mapping
0x603F	VAR	error_code	UNSIGNED16	RO	Yes
0x6502	VAR	supported_drive_modes	UNSIGNED32	RO	Yes

11.18.6 Error code

Table 11.60 error_code

Index	0x603F	Object code	VAR	Access	RO
Sub-index	0	Data type	UNSIGNED16	PDO mapping	Yes
Default	N/A	Units	None		

The **error_code** captures the code of the last error that occurred in the drive. It corresponds to the value of the low 16 bits of object 0x1003, **pre_defined_error_field**.

11.18.7 Supported drive modes

Table 11.61 supported_drive_modes

Index	0x6502	Object code	VAR	Access	RO
Sub-index	0	Data type	UNSIGNED32	PDO mapping	Yes
Default	0xA	Units	None		

SI-CANopen supports profile torque mode and velocity mode.

Table 11.62 supported_drive_modes bit descriptions

Bit number	Description
0	Profile position mode
1	Velocity mode
2	Profile velocity mode (not supported)
3	Profile torque mode
4	Reserved
5	Homing mode (not supported)
6	Interpolated position mode (not supported)
7 to 15	Reserved
16 to 31	Manufacturer specific

Device control

Device control objects are used to control the operation of the drive.

Table 11.63 Device control supported objects

Index	Object	Name	Type	Access	PDO mapping
0x6040	VAR	controlword	UNSIGNED16	RW	Yes
0x6041	VAR	statusword	UNSIGNED16	RW	Yes
0x605A	VAR	quick_stop_option_code	INTEGER16	RW	No
0x605B	VAR	shut_down_option_code	INTEGER16	RW	No
0x605C	VAR	disable_operation_option_code	INTEGER16	RW	No
0x6060	VAR	modes_of_operation	INTEGER8	WO	Yes
0x6061	VAR	modes_of_operation_display	INTEGER8	RO	Yes

Controlword

Index	0x6040	Object code	VAR	Access	RW
Sub-index	0	Data type	UNSIGNED16	PDO mapping	Yes
Default	N/A	Units	None		

controlword provides the commands for logical control (enable, run, reset, etc.) of the drive, according to the pre-defined **controlword** state machine. In each state, the SI-CANopen will convert **controlword** and set the drive control word (Pr 06.042) as required to attain the required operating state.

NOTE The drive control word must be enabled by setting Pr 06.043 to ON (or 1) to allow **controlword** to control Pr 06.042.

Table 11.64 Controlword bit descriptions

Bit	Name	Description
0	SWITCH ON	Used (with controlword b7) to control the operating state of the device profile.
1	DISABLE VOLTAGE	
2	QUICK STOP	
3	ENABLE OPERATION	
4	Operation mode specific	Not used by SI-CANopen.
5		
6		
7	FAULT RESET	Used (with controlword b0-b3) to control the operating state of the device profile.
8-10	Reserved	Reserved
11	AUTO	Set to 1 to enable controlword control of the drive. AUTO directly controls the AUTO bit (b7) of Pr 06.042 .
12-15	Manufacturer specific	Not used by SI-CANopen

Seven device commands are used to switch between different control states, and these are listed in Table 11.65 below.

Table 11.65 Example control words

Command	FAULT RESET	ENABLE OPERATION	QUICK STOP	DISABLE VOLTAGE	SWITCH ON	Transitions affected
Shutdown	0	X	1	1	0	2, 6, 8
Switch on	0	X	1	1	1	3
Disable voltage	0	X	X	0	X	7, 9, 10, 12
Quick stop	0	X	0	1	X	7, 10, 11
Disable operation	0	0	1	1	1	5
Enable operation	0	1	1	1	1	4, 16
Fault reset	0-1	X	X	X	X	15

States may be changed using the **controlword** and/or internal events. The current state can be read using the statusword.

Figure 11-3 Controlword state diagram

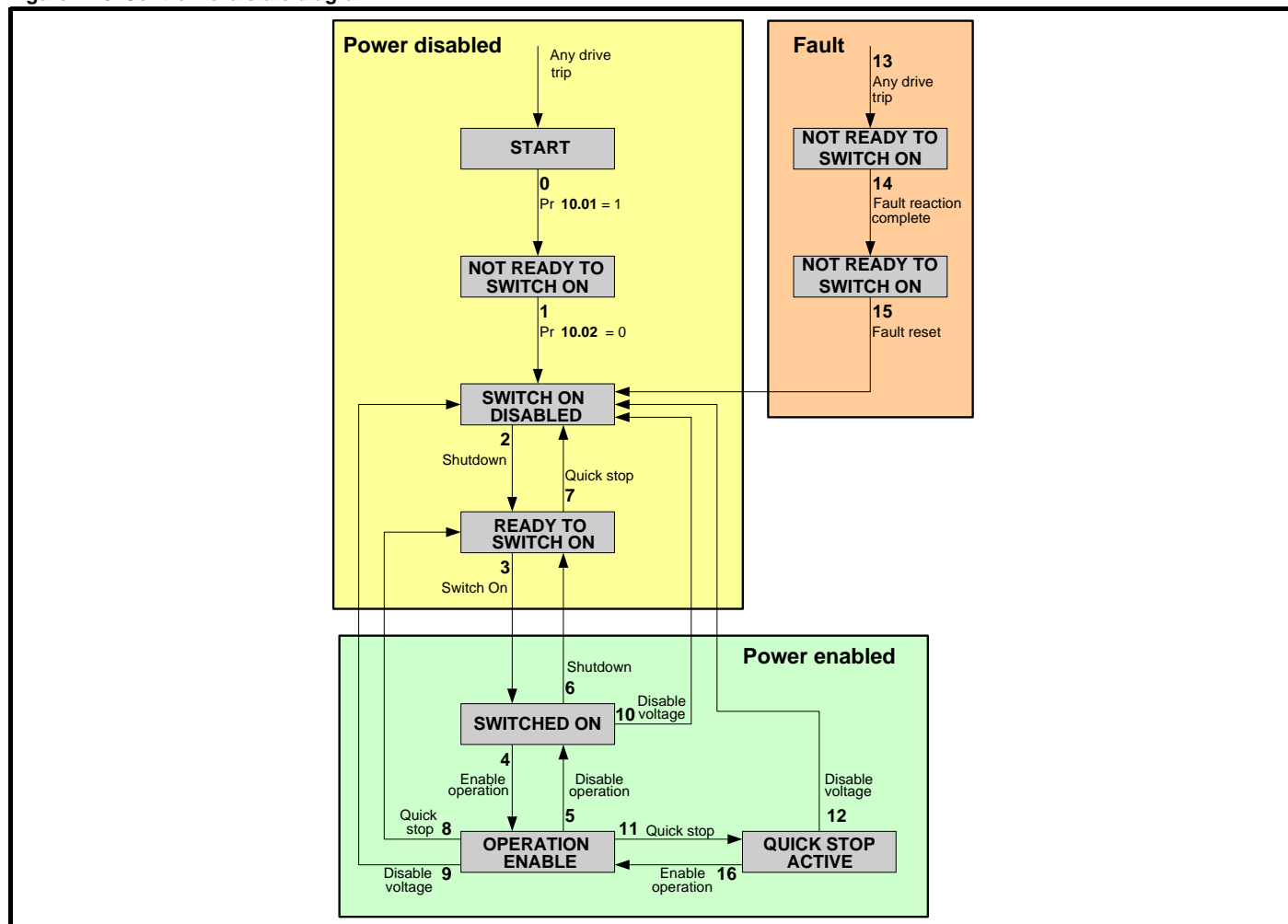

State transitions are caused by internal events in the drive or by commands received from the host via the **controlword** (refer to Figure 11-3 *Controlword state diagram* on page 98).

Table 11.66 State transitions for profile control

State transition	Event	Action
0	Pr 10.01 = 1	Drive must not be tripped when controlword initializes.
1	Pr 10.02 = 0	Drive must be disabled when controlword initializes.
2	controlword = "Shutdown"	Specified ramp mode selected in drive.
3	controlword = "Switch on"	Select decel ramp 1, Pr 02.020 = 1 Set decel ramp rate, Pr 02.021 as required Set Pr 06.042 bit 0 to 1.
4	controlword = "Enable operation"	Select decel ramp 1, Pr 02.020 = 1 Set decel ramp rate, Pr 02.021 as required Set Pr 06.042 bit 1 to 1.
5	controlword = "Disable operation"	Specified ramps selected in drive Reset Pr 06.042 bit 1 to 0.
6	controlword = "Shutdown"	Specified ramps selected in drive Reset Pr 06.042 bit 1 to 0.
7	controlword = "Quick stop"	Move to Switch On Disabled.
8	controlword = "Shutdown"	Specified ramps selected in drive Reset Pr 06.042 bit 0 and bit 1 to 0.
9	controlword = "Disable voltage"	Reset Pr 06.042 bit 0 and bit 1 to 0.
10	controlword = "Disable voltage" or "Quick stop"	Specified ramps selected in drive Reset Pr 06.042 bit 0 to 0.
11	controlword = "Quick stop"	Specified ramps selected in drive Reset Pr 06.042 bit 1 to 0.
12	Quick stop complete or controlword = "Disable voltage"	Reset Pr 06.042 bit 0 to 0.
13	Pr 10.01 = 1	drive trip.
14	Fault reaction complete	Reset Pr 06.042 bit 0 and bit 1 to 0.
15	controlword = "Fault reset"	Specified ramps selected in drive.
16	controlword = "Enable operation"	Specified ramps selected in drive Reset Pr 06.042 bit 1 to 1.

If a command is received which causes a change of state, this command must be processed completely and the new state attained before the next command can be processed.

NOTE State transition 16 is only available if the **quick_stop_option_code** is set to 5, 6, 7 or 8. Specified ramps are defined by **shutdown_option_code**, **quick_stop_option_code** and **disable_operation_option_code**.

11.18.8 Statusword

Table 11.67

Index	0x6041	Object code	VAR	Access	RO
Sub-index	0	Data type	UNSIGNED16	PDO mapping	Yes
Default	N/A	Units	None		

The **statusword** indicates the current status of the drive. The **statusword** bits are defined in Table 11.68.

Table 11.68 **statusword** bit descriptions

Bit	Name	Source
0	READY TO SWITCH ON	Controlled by the device control state machine (see Table 11.69).
1	SWITCHED ON	
2	OPERATION ENABLED	
3	FAULT	
4	VOLTAGE DISABLED	VOLTAGE_DISABLED will be set to 1 when SI-CANopen is responding to the "Disable voltage" command in the controlword .
5	QUICK STOP	Controlled by the device control state machine (see Table 11.69).
6	SWITCH ON DISABLED	
7	Reserved	
8	Reserved	
9	REMOTE	Indicates that the drive is being controlled by controlword . Set to 1 if both control word enable (Pr 06.043) and AUTO bit (Pr 06.042 bit 7) are set to 1.
10	TARGET	Indicates the "At Speed" indication (Pr 10.006) from the drive. When quick stop is active, TARGET returns the "Drive Running" bit. (Pr 10.002).
11	INTERNAL LIMIT ACTIVE	Set if vl_velocity_demand goes outside the limits specified in vl_velocity_min_max_amount .
12-15	Reserved	

Table 11.69 shows the values of **statusword** in each state. Bits marked X are not applicable for that state, and other combinations are not allowed.

Table 11.69 **statusword** value

State	SWITCH ON DISABLED	QUICK STOP	FAULT	OPERATION ENABLED	SWITCHED ON	READY TO SWITCH ON
NOT READY TO SWITCH ON	0	X	0	0	0	0
SWITCH ON DISABLED	1	X	0	0	0	0
READY TO SWITCH ON	0	1	0	0	0	1
SWITCHED ON	0	1	0	0	1	1
OPERATION ENABLED	0	1	0	1	1	1
FAULT	0	X	1	1	1	1
FAULT REACTION ACTIVE	0	X	1	1	1	1
QUICK STOP ACTIVE	0	0	0	1	1	1

11.18.9 Shutdown option code

Index	0x605B	Object code	VAR	Access	RW
Sub-index	0	Data type	INTEGER16	PDO mapping	No
Default	0	Units	None		

The **shutdown_option_code** parameter determines what action should be taken if there is a transition from OPERATION ENABLED to READY TO SWITCH ON, state transition 8. Refer to the manufacturer specific option codes in Table 11.73 *Manufacturer specific quick_stop_option_code codes* on page 102 for full details of all stopping modes available. Ramps must be enabled (Pr 02.002 = ON or 1) for the ramp functions to work correctly.

Table 11.70 **shutdown_option_code** codes

Value	Action	Parameter settings	Description
0	Disable drive function	Pr 06.001 = 0	Select coast stop.
1	Slow down on slow down ramp, then disable drive function	Pr 06.001 = 1	Select ramp stop.
		Pr 02.020 = 2	Select ramp Pr 02.022.
		Pr 02.004 = 1	Select standard ramp with normal. Motor voltage.

11.18.10 Disable operation option code

Index	0x605C	Object code	VAR	Access	RW
Sub-index	0	Data type	INTEGER16	PDO mapping	No
Default	1	Units	None		

The **disable_operation_option_code** parameter determines what action should be taken if there is a transition from OPERATION ENABLE to SWITCHED ON, state transition 5. Refer to the manufacturer specific option codes in Table 11.73 *Manufacturer specific quick_stop_option_code codes* on page 102 for full details of all stopping modes available. Ramps must be enabled (Pr **02.002** = ON or 1) for the ramp functions to work correctly.

Table 11.71 *disable_operation_option_code codes*

Value	Action	Parameter settings	Description
0	Disable drive function	Pr 06.001 = 0	Select coast stop.
1	Slow down on slow down ramp, then disable drive function	Pr 06.001 = 1 Pr 02.020 = 2 Pr 02.004 = 1	Select ramp stop. Select ramp Pr 02.022 . Select standard ramp with normal. motor voltage.

11.18.11 Quick stop option code

Index	0x605A	Object code	VAR	Access	RW
Sub-index	0	Data type	INTEGER16	PDO mapping	No
Default	2	Units	None		

The **quick_stop_option_code** parameter determines what action should be taken if the quick stop function is executed. Ramps must be enabled (Pr **02.002** = ON or 1) for the ramp functions to work correctly.

Table 11.72 *quick_stop_option_code codes*

Value	Action	Parameter settings	Description
0	Disable drive function	Pr 06.001 = 0	Select coast stop.
1	Slow down on slow down ramp	Pr 06.001 = 1 Pr 02.020 = 2 Pr 02.004 = 1	Select ramp stop. Select ramp Pr 02.022 . Select standard ramp with normal motor voltage.
2	Slow down on quick stop ramp	Pr 06.001 = 1 Pr 02.020 = 3 Pr 02.004 = 0	Select ramp stop. Select ramp Pr 02.023 . Select fast ramp.
3	Not supported	-	-
4		-	-
5	Slow down on slow down ramp and stay in quick-stop	Pr 06.001 = 1 Pr 02.020 = 2 Pr 02.004 = 1	As 1 with stay in quick-stop.
6	Slow down on quick stop ramp and stay in quick-stop	Pr 06.001 = 1 Pr 02.020 = 3 Pr 02.004 = 0	As 2 with stay in quick-stop.
7	Not supported	-	-
8		-	-

NOTE Options 9 to 32767 are all reserved for possible future use.

Some manufacturer specific options are also available. These allow the various ramp modes implemented in the SI-CANopen to be used.

Table 11.73 Manufacturer specific *quick_stop_option_code* codes

Value	Action	Parameter settings	Description
-1	Slow down on slow down ramp with timed DC injection	Pr 06.001 = 2 Pr 02.020 = 2 Pr 02.004 = 1	Select ramp stop with timed DC injection. Select ramp Pr 02.022 . Select standard ramp with normal motor voltage.
-2	Slow down on quick stop ramp with timed DC injection	Pr 06.001 = 2 Pr 02.020 = 3 Pr 02.004 = 0	Select ramp stop with timed DC injection. Select ramp Pr 02.023 . Select fast ramp.
-3	Slow down on slow down ramp with high motor voltage	Pr 06.001 = 1 Pr 02.020 = 2 Pr 02.004 = 2	Select ramp stop. Select ramp Pr 02.022 . Select standard ramp with high motor voltage.
-4	Slow down on slow down ramp with high motor voltage and timed dc injection	Pr 06.001 = 2 Pr 02.020 = 2 Pr 02.004 = 2	Select ramp stop with timed DC injection. Select ramp Pr 02.022 . Select standard ramp with high motor voltage.
-5	Injection braking stop with detection of zero speed	Pr 06.001 = 3	Select injection braking stop.
-6	Timed injection braking stop	Pr 06.001 = 4	Select timed injection braking stop.
-7 to -10	Reserved	-	-
-11	As -1 with stay in quick stop	Pr 06.001 = 2 Pr 02.020 = 2 Pr 02.004 = 1	Select ramp stop with timed DC injection. Select ramp Pr 02.022 . Select standard ramp with normal motor voltage.
-12	As -2 with stay in quick stop	Pr 06.001 = 2 Pr 02.020 = 3 Pr 02.004 = 0	Select ramp stop with timed DC injection. Select ramp Pr 02.023 . Select fast ramp.
-13	As -3 with stay in quick stop	Pr 06.001 = 1 Pr 02.020 = 2 Pr 02.004 = 2	Select ramp stop. Select ramp Pr 02.022 . Select standard ramp with high motor voltage.
-14	As -4 with stay in quick stop	Pr 06.001 = 2 Pr 02.020 = 2 Pr 02.004 = 2	Select ramp stop with timed DC injection. Select ramp Pr 02.022 . Select standard ramp with high motor voltage.
-15	As -5 with stay in quick stop	Pr 06.001 = 3	Select injection braking stop.
-16	As -6 with stay in quick stop	Pr 06.001 = 4	Select timed injection braking stop.

Options -7 to -10, and -17 to -32768 are all reserved for possible future use.

11.18.12 Modes of operation

Index	0x6060	Object code	VAR	Access	WO
Sub-index	0	Data type	INTEGER8	PDO mapping	Yes
Default	N/A	Units	None		

The **modes_of_operation** parameter selects the internal profile which should be used. SI-CANopen supports velocity mode and profile torque mode. SI-CANopen profiles must be enabled by setting Pr **S.01.020** to 1 (ON). See parameter **S.01.020** in Section 6.1.2. for more information. Basic implementations of two DSP402 device profiles (profile torque and velocity) have been included in the SI-CANopen, and supported objects are detailed in this section. Additional features may be implemented in an SI-Applications DPL program. (where supported).

Table 11.74 *modes_of_operation* codes

Value	Action
-1	No profile enabled
0	Reserved
1	Not supported
2	Velocity mode
3	Not supported
4	Torque profile mode
5 - 7	Not supported

11.18.13 Modes of operation display

Index	0x6061	Object code	VAR	Access	RO
Sub-index	0	Data type	INTEGER8	PDO mapping	Yes
Default	N/A	Units	None		

The *modes_of_operation_display* parameter shows the currently selected profile. See section 11.18.12 *Modes of operation* on page 102.

11.18.14 Profile torque mode

Table 11.75 shows a summary of all supported objects of the profile torque mode. Profile torque mode must be enabled by setting *modes_of_operation* to 4 (see section 11.18.12 *Modes of operation* on page 102).

Table 11.75 Profile torque mode supported objects

Index	Object	Name	Type	Access	PDO mapping
0x6071	VAR	target_torque	INTEGER16	RW	Yes
0x6077	VAR	torque_actual_value	INTEGER16	RO	Yes
0x6075	VAR	motorRatedCurrent	UNSIGNED32	RW	Yes
0x6087	VAR	torque_slope	UNSIGNED32	RW	Yes
0x6088	VAR	torque_profile_type	INTEGER16	RW	Yes

Figure 11-76 Profile torque mode objects supported by SI-CANopen

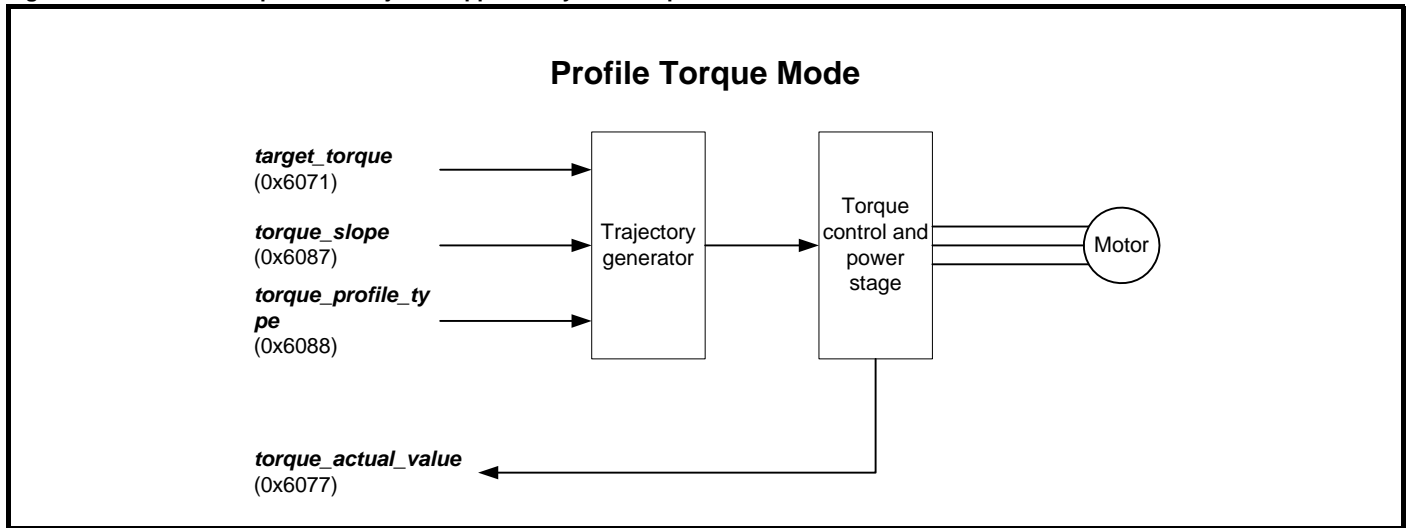

11.18.15 Target torque

Index	0x6071	Object code	VAR	Access	RW
Sub-index	0	Data type	INTEGER16	PDO mapping	Yes
Default	0	Units	per thousand of rated torque		

target_torque is the input value for the torque controller. This object is multiplied by 10 and written directly to Pr **04.008** when *controlword* is in the power enabled group of states. Refer to Figure 11-3 on page 98.

11.18.16 Torque actual value

Index	0x6077	Object code	VAR	Access	RO
Sub-index	0	Data type	INTEGER16	PDO mapping	Yes
Default	0	Units	per thousand rated current		

torque_actual_value refers to the instantaneous torque being delivered by the motor. Pr **04.020** is returned in this object.

11.18.17 Motor Rated Current

Index	0x6075	Object code	VAR	Access	RW
Sub-index	0	Data type	UNSIGNED32	PDO Mapping	Yes
Default	0	Units	1mA		

This value is taken from the motor name plate and is entered as units of 1 mA (or 0.001 A). It is directly linked to Pr **05.007** of the drive when using the default motor map, and Pr **21.007** when using motor map 2.

11.18.18 Torque slope

Index	0x6087	Object code	VAR	Access	RW
Sub-index	0	Data type	UNSIGNED32	PDO mapping	Yes
Default	0	Units	per thousand of rated torque per second		

torque_slope describes the maximum rate of change of torque permitted. When a change in **target_torque** is seen, SI-CANopen will apply a ramp to the torque reference before updating the torque reference parameter, Pr **04.008**.

11.18.19 Torque profile type

Index	0x6088	Object code	VAR	Access	RW
Sub-index	0	Data type	INTEGER16	PDO mapping	Yes
Default	0	Units	None		

The **torque_profile_type** is used to select the type of torque profile used to perform a torque change. Only linear ramps are supported.

Table 11.77 torque_profile_type codes

Profile code	Profile type
0	Linear ramp (trapezoidal profile)
1	Not supported

11.18.20 Velocity mode objects

Table 11.78 shows a summary of all supported objects of the velocity mode. Velocity mode must be enabled by setting the **modes_of_operation** object to 2 (see section 11.18.12 Modes of operation on page 102).

Table 11.78 Velocity mode supported objects

Index	Object	Name	Type	Access	PDO mapping
0x6042	VAR	vl_target_velocity	INTEGER16	RW	Yes
0x6043	VAR	vl_velocity_demand	INTEGER16	RO	Yes
0x6044	VAR	vl_control_effort	INTEGER16	RO	Yes
0x6046	ARRAY	vl_velocity_min_max_amount	UNSIGNED32	RW	Yes
0x6048	RECORD	vl_velocity_acceleration	RAMP	RW	Yes
0x6049	RECORD	vl_velocity_deceleration	RAMP	RW	Yes
0x604C	ARRAY	vl_dimension_factor	INTEGER32	RW	Yes
0x604D	VAR	vl_pole_number	UNSIGNED8	RW	Yes

Figure 11-79 Velocity mode objects supported by SI-CANopen

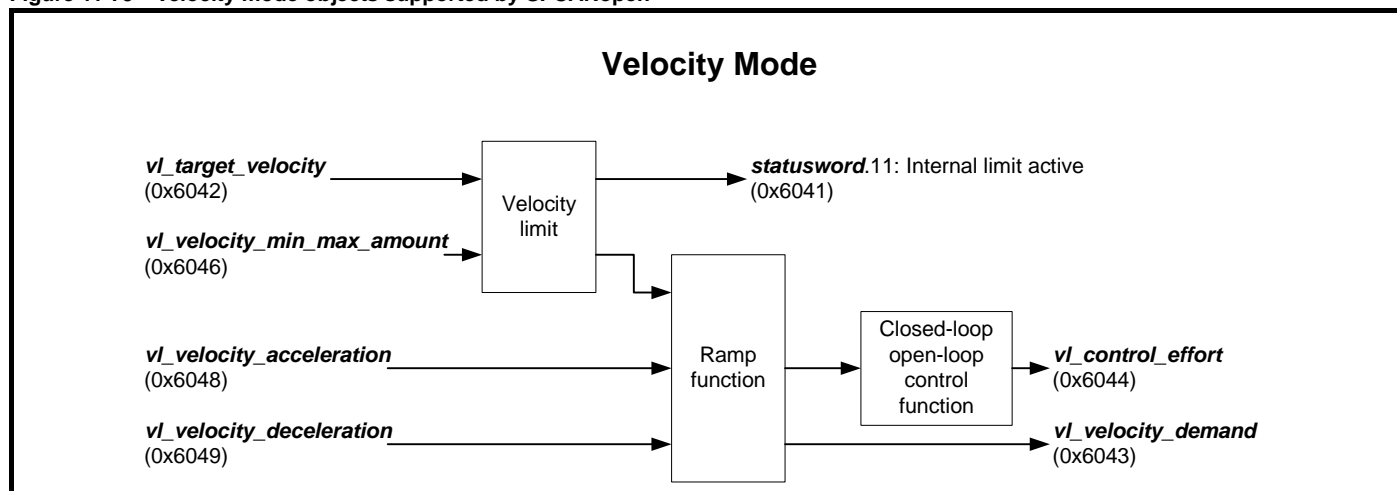

Index	0x6042	Object code	VAR	Access	RW
Sub-index	0	Data type	INTEGER16	PDO mapping	Yes
Default	0	Units	rpm		

vl_target_velocity is the required velocity of the system and is written to Pr **01.021**. The units of **vl_target_velocity** are rpm, and range from -32768 to +32767.

11.18.21 VI target velocity

Figure 11-4 *vl_target_velocity*

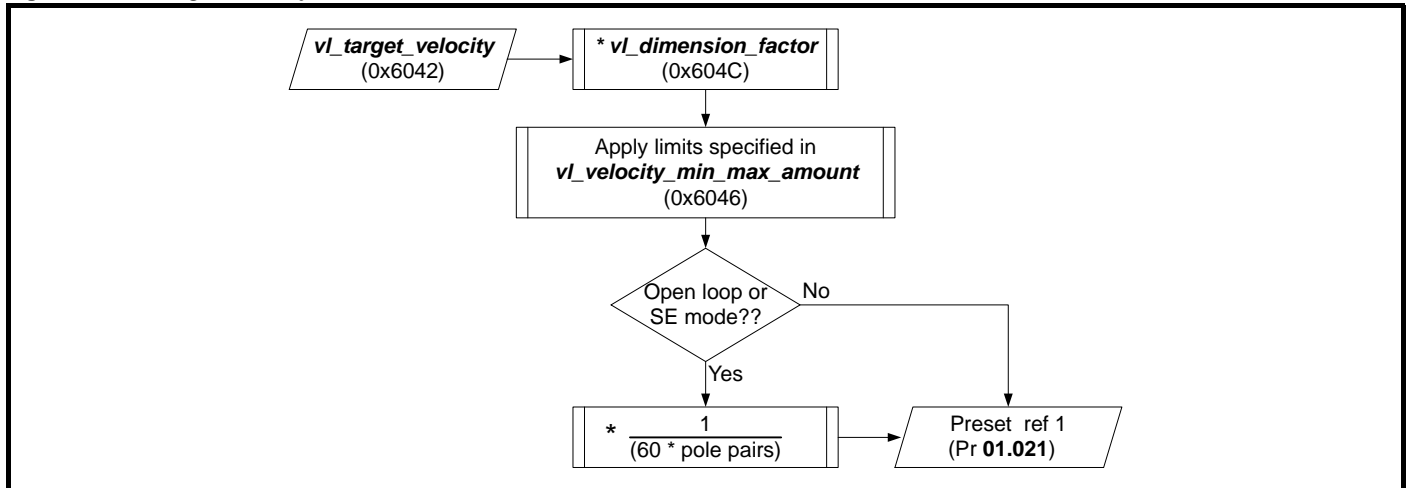

11.18.22 VI velocity demand

Index	0x6043	Object code	VAR	Access	RO
Sub-index	0	Data type	INTEGER16	PDO mapping	Yes
Default	N/A	Units	rpm		

vl_velocity_demand is the instantaneous velocity provided by the ramp function, is sourced from Pr 02.001. This object is scaled to the units of *vl_target_velocity* and ranges from -32768 to +32767 rpm.

Figure 11-5 *vl_velocity_demand*

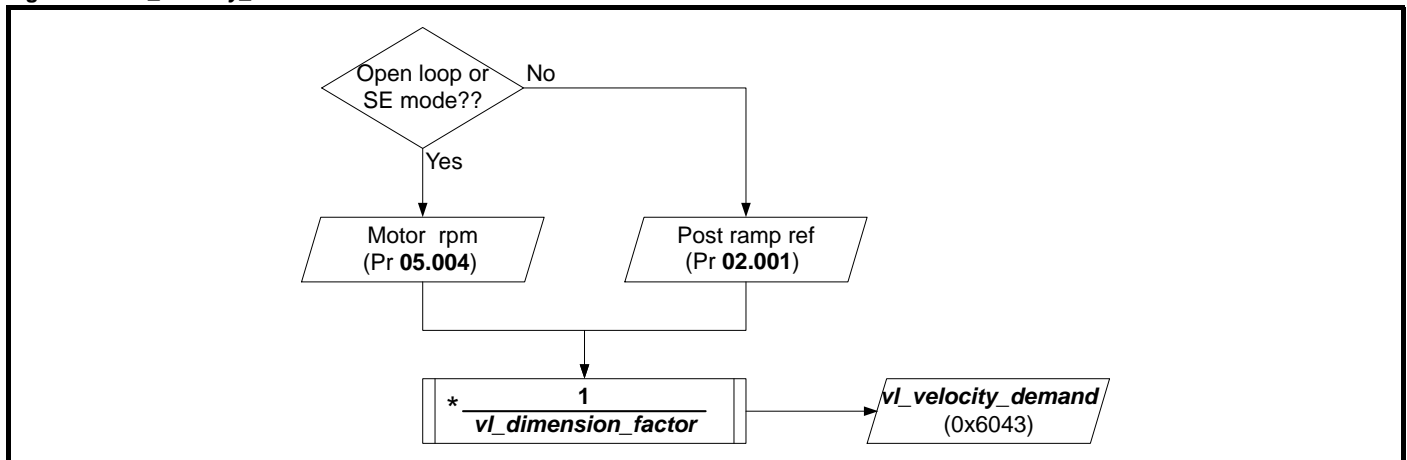

11.18.23 VI control effort

Index	0x6044	Object code	VAR	Access	RO
Sub-index	0	Data type	INTEGER16	PDO mapping	Yes
Default	N/A	Units	rpm		

vl_control_effort is the velocity of the motor spindle or load and scaled to the units of *vl_target_velocity*. The value ranges from -32768 to +32767.

Figure 11-6 *vl_control_effort*

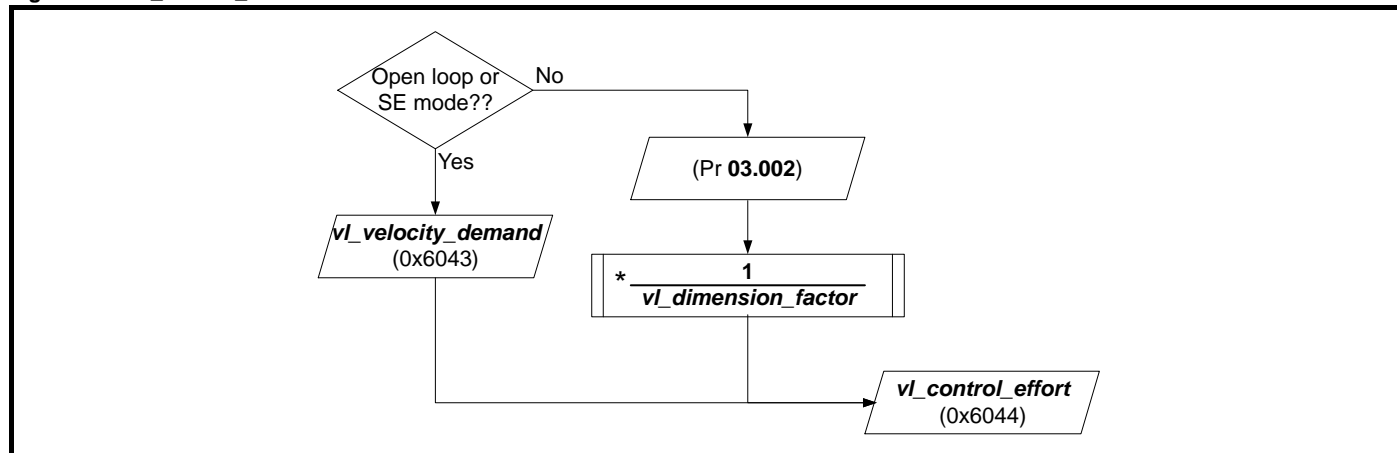

11.18.24 VI velocity min max amount

Index	0x6046	Object Type	ARRAY
Elements	2		

vl_velocity_min_max_amount specifies minimum and maximum clamp values that must be applied to the calculated velocity value, before it is written to the drive. The minimum clamp value is checked first, followed by the maximum clamp value.

vl_velocity_min_amount

Index	0x6046	Object code	VAR	Access	RW
Sub-index	1	Data type	UNSIGNED32	PDO mapping	Yes
Default	0	Units	rpm		

vl_velocity_min_amount specifies the minimum clamp value for the internal velocity calculation. *vl_velocity_min_amount* is not mapped to Pr 01.007 as Pr 01.007 is not active when the drive is in bi-polar mode. *vl_velocity_min_amount* is limited to 0x7FFFFFFF, as this is the maximum positive value for the INTEGER32 internal velocity calculation. This prevents the minimum speed clamp from being set to an illegal value.

vl_velocity_max_amount

Index	0x6046	Object code	VAR	Access	RW
Sub-index	2	Data type	UNSIGNED32	PDO mapping	Yes
Default	Pr 1.06	Units	rpm		

vl_velocity_max_amount specifies the maximum clamp value for the internal velocity calculation. *vl_velocity_max_amount* is read from Pr 01.006 during initialization, but Pr 01.006 will NOT be updated if *vl_velocity_max_amount* is subsequently changed. This allows the maximum speed clamp for the drive to be set higher to allow for possible position recovery or speed overshoot during operation.

11.18.25 VI velocity acceleration

Index	0x6048	Object Type	RECORD
Elements	2		

vl_velocity_acceleration specifies the slope of the acceleration ramp. It is calculated by dividing *delta_speed* by *delta_time*. By default, *delta_speed* is set to 0, so the acceleration ramp is effectively disabled. *vl_velocity_acceleration* is converted and written to Pr 02.011 when *delta_speed* or *delta_time* are updated.

Figure 11-7 *vl_velocity_acceleration*

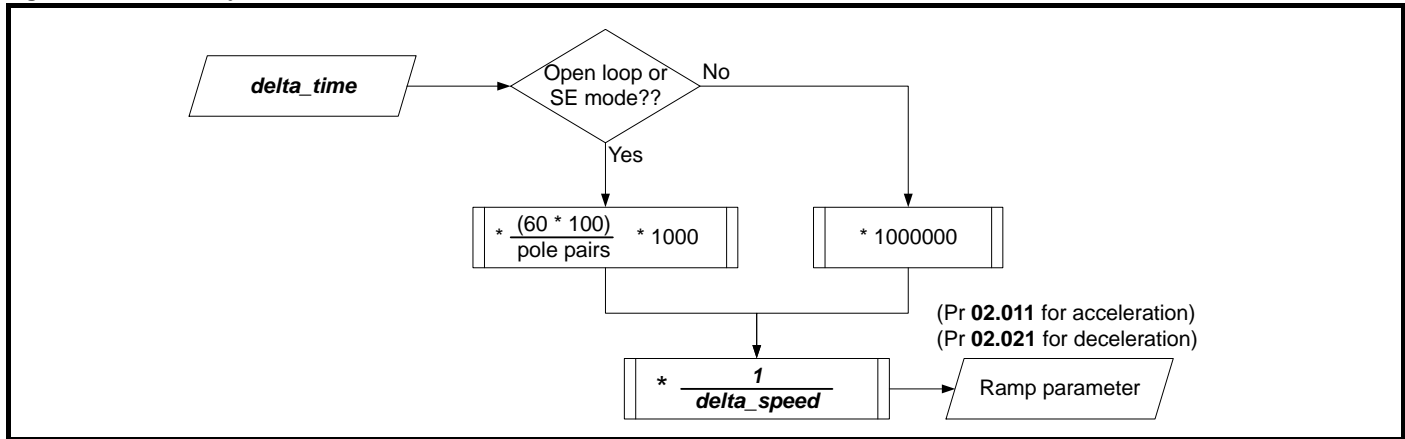

delta_speed

Index	0x6048	Object code	VAR	Access	RW
Sub-index	1	Data type	UNSIGNED32	PDO mapping	Yes
Default	0	Units	rpm		

delta_time

Index	0x6048	Object code	VAR	Access	RW
Sub-index	2	Data type	UNSIGNED16	PDO mapping	Yes
Default	1	Units	Seconds		

delta_time is multiplied by a scaling factor and divided by *delta_speed* to calculate the setting for Pr 02.011. When *delta_time* is multiplied by the scaling factor, the interim result must not exceed the maximum range of an UNSIGNED32 value. This equates to 4294 seconds in RFC-A or RFC-S mode and 1431 seconds in open loop mode on a 4-pole motor.

11.18.26 VI velocity deceleration

Index	0x6049	Object Type	RECORD
Elements	2		

vl_velocity_deceleration specifies the slope of the deceleration ramp. It is calculated by dividing *delta_speed* by *delta_time* (see Figure 11-7 *vl_velocity_acceleration* on page 107). By default, *delta_speed* is set to 0, so the deceleration ramp is effectively disabled.

vl_velocity_deceleration is converted and written to Pr 02.021 when *delta_speed* or *delta_time* are updated.

delta_speed

Index	0x6049	Object code	VAR	Access	RW
Sub-index	1	Data type	UNSIGNED32	PDO mapping	Yes
Default	0	Units	rpm		

delta_time

Index	0x6049	Object code	VAR	Access	RW
Sub-index	2	Data type	UNSIGNED16	PDO mapping	Yes
Default	1	Units	Seconds		

delta_time is multiplied by a scaling factor and divided by *delta_speed* to calculate the setting for Pr 02.021. When *delta_time* is multiplied by the scaling factor, the interim result must not exceed the maximum range of an UNSIGNED32 value. This equates to 4294 seconds in RFC-A or RFC-S mode, and 1431 seconds in open loop mode on a four pole motor.

11.18.27 VI pole number

Index	0x604D	Object code	VAR	Access	RW
Sub-index	0	Data type	UNSIGNED8	PDO Mapping	Yes
Default		Units	Number of poles		

This value defines the number of poles of the motor currently being used. It is directly linked to Pr 05.011 of the drive when using the default motor map, and Pr 21.011 when using motor map 2.

12 Diagnostics

12.1 Overview

This section provides basic diagnostic information intended to resolve the most common problems encountered when setting up an SI-CANopen module on a SI-CANopen network.

A high percentage of problems reported are basic set-up problems which can usually be solved by reading the information in this chapter. If after reading this chapter you are still experiencing problems, please contact your supplier for support.

12.1.1 Drive trip display codes

If the option module detects an error during operation, it will force a trip on the drive. However, the trip string displayed on the drive will only indicate which slot initiated the trip. The exact reason for the trip will be indicated in the drive trip code parameters (Pr **10.020** and Pr **10.070**).

Table 12-1 shows the possible trips that will be displayed on the drive when a problem is detected with the option module or when the option module initiates a trip.

Table 12-1 Drive trip display codes

Trip	Description
SlotX HF	The drive has detected that an option module is present but is unable to communicate with it due to a hardware fault.
SlotX Error	User trip generated by the option module
SlotX Not Fitted	This trip will occur if a drive slot was previously configured with an option module but on power up, no option module was detected.
SlotX Different	This trip will occur if a drive slot was previously configured with an option module but on power up, a different option module was detected. Replacing the option module with another one of the same ID number will not initiate this trip. The trip will also occur if an option module is installed to a previously unused slot.

12.1.2 Module error codes

If the option module detects an internal error during operation, it will force a trip on the drive and provide a sub-trip string for a clearer definition of the trip. Table 12-2 below shows the possible module error codes.

Table 12-2 Module error codes

Value	Text	Description
200	SW fault	Software fault
201	BG Orun	Background task overrun
202	FW invalid	Invalid firmware for hardware version
203	Drv unknown	Unknown drive type
204	Drv unsupported	Unsupported drive type
205	Mode unknown	Unknown mode
206	Mode unsupported	Unsupported mode
207	FLASH corrupt	Corrupted Non-volatile Flash
208	Dbase init	Database initialization error
209	FS init	File system initialization error
210	Memory alloc	Memory allocation error
211	Filesystem	File system error
212	Save Configuration	Save Configuration file error
213	Load Configuration	Load Configuration file error
214	OHT	Overheated
215	TO drv	The drive has not responded with the watchdog period
216	eCMP	eCMP comms failure
217	TO eCMP slot 1	Slot 1 eCMP timeout
218	TO eCMP slot 2	Slot 2 eCMP timeout
219	TO eCMP slot 3	Slot 3 eCMP timeout
220	TO eCMP slot 4	Slot 4 eCMP timeout
221	Output overload	Digital output overload
222	Missing Factory Setting	Missing Factory Settings
223	Power on test	Error during power-up. e.g. Thermistor short/open circuit.

12.1.3 SI-CANopen error codes

If the SI-CANopen module detects a CANopen error during operation, it will force a trip on the drive and provide a sub-trip string for a clearer definition of the trip. The table below shows all possible CANopen error codes.

Table 12.1 CANopen network error codes

Value	Text	Description
0	No trip	No trip.
100	Link Loss	The link to the network has been lost.
101	Bus Off	The CAN layer of the module has entered the Bus Off state.

12.1.4 SI-CANopen network diagnostic

The operating status of the SI-CANopen module can be viewed in the network diagnostic parameter (Pr **S.01.006**). All possible values for this parameter are described in Table 12-3 .

Table 12-3 SI-CANopen network operating status Baud rate detection in progress

Value	Text	Description
0	Network OK	Network healthy.
1	Internal HW Fail	Indicates that part of the SI-CANopen initialization sequence was not successful. If this fault persists after a power cycle, replace the SI-CANopen module.
2	Init OK	Indicates that SI-CANopen has initialized correctly, and is waiting for the CANopen master to initialize communications.
3	Network No Data	Indicates the the CANopen master has established communications with SI-CANopen, but currently there is no data transfer in progress.
4	Config Error	Indicates that there is an invalid setting in the SI-CANopen configuration parameters. This could be due to a mapping error.
5	Software Error	An internal software error has occurred. Reset SI-CANopen to clear this error. If the error persists, replace SI-CANopen.
6	Baud Detecting	Baud rate detection is in progress.
7	Device Disabled	Indicates that the CANopen communications layer has been disabled by setting the node address to 0.
8	Initialize Delay	initialization delayed, waiting for application module(s) to finish initial task.

12.1.5 Alarms

If the SI-CANopen detects an alarm during operation, it will cause the drive to display the appropriate alarm on the drive keypad. If more than one alarm is present, it will be shown as "first-in-first-out" (FIFO) order.

Value	Text	Description
0	No alarm	No alarm.
1	User Prog	A user program alarm has been generated.
2	eCMP	An eCMP alarm has been generated.
3	FS Usage	A file system alarm has been generated.
4	Too Hot	Module temperature is too high.
5	In Mapping	Error with Input mapping setup.
6	Out Mapping	Error with Output mapping setup.
7	Fbus Init	Fieldbus Initialization failed, possibly due to external 24 V missing or baud rate detection failed.
8	Read Err	Error during reading from a mapped parameter.
9	Write Err	Error during writing to a mapped parameter.

13 Glossary of terms

Address: This is the unique network identification given to a networked device to allow communication on a network. When a device sends or receives data the address is used to determine the source and the destination of the message.

Alignment: By default SI-CANopen transmits values as 32 bits on the network. It is possible by using alignment to reduce the number of bits transmitted when sending 16-bit (or smaller) values on the network to 16-bit (32-bit values will still be transmitted as 32-bit values). This has the advantage of reducing the volume of traffic on the network and allowing more parameters to be mapped within SI-CANopen.

Bit: A binary digit, this may have the value of 1 or 0.

Byte: A collection of 8 binary digits that collectively store a value. This may be signed or unsigned.

CAN: The base network used for CANopen. The CANopen module does not support CAN commands.

CANopen: Builds on the basic CAN protocol by offering higher level functionality.

Casting: The process of changing between data sizes without changing the value represented, e.g. changing from 16-bit to 32-bit.

Consistency: Describes how data is transmitted between nodes on the network. If data is consistent it is transmitted from node to node as a single entity. Thus preventing data corruption where multiple bytes are transmitted or received individually.

Control word: A collection of binary digits that are used to control the drive. Features typically include directional controls, run controls and other similar functions.

Cyclic data: This consists of values that are sent at regular or cyclic intervals across the network. A typical use of cyclic data would be the transmission of a speed reference or a control word.

Data format: Determines the quantity and function of the data sent and received across the network.

Data rate: Determines the communication speed of the network, the higher the value the more data can be sent across the network in the same time period.

Device: A piece of equipment connected to a network, this may be any type of equipment including repeaters, hubs, masters or slaves.

Double word: A 32-bit word, this may be signed or unsigned.

Earthing/Grounding: Describes the electrical safety or shielding connections for the module.

Event task: A special way to use a message or change of state to trigger a software routine.

IN data: Data that is returned from a slave device to the CANopen master.

Long word: A 32-bit data word that may be signed or unsigned.

Mapping: The process of linking CANopen values to parameters within the drive.

Master: The controlling device on the network, generally this will include programming features.

Network Loss Trip: A method to determine when a node has lost contact with the master.

Node: A device on the network. This may be either a device such as a drive or part of the network such as a repeater.

Non-Cyclic Data: Data that is requested or sent by the master as required. This is not sent on a regular basis and generally allows access to any parameter. This is useful for occasional changes or configuration purposes.

Object Dictionary: A collection of the objects that are supported by the product.

Poll rate: The rate at which cyclic data is sent and received on the network.

Response ID: The response code of the message received when using PPO4 word non-cyclic communication.

Scan rate: See Poll rate in this section.

Shielding: A connection to provide additional immunity to noise used on a network cable.

Segment: An electrically separate part of the network. Each segment requires correct termination to ensure reliable operation. Due to electrical limitations the maximum number of devices on a segment is limited to 32.

Slave: A device on the CANopen network such as a drive or sensor. A slave device will only respond to messages from a master.

Status word: A value that denotes the status of the drive. Each bit within the word will have a specific meaning.

Task ID: The code used to describe the purpose of a message using PPO 4 word non-cyclic communication.

Termination: This is used at both ends of a network segment to prevent reflections and reduce noise.

Watchdog: A method used to determine if a communication system is ok/healthy. A typical watchdog scheme uses a handshaking system to check both the master and slave are participating in communications.

Word: A collection of 16 binary digits.

Index

A		M	
Above set speed	60	Manufacturer device name	65
Activate bit timing	91	Manufacturer hardware version	65
At speed	60	Manufacturer software version	65
B		Manufacturer status register	64
Basic data types	62	Maximum network length	11
Below set speed	60	Minimum node to node cable length	11
Blank mapping parameters	53	Modbus channel	95
C		Mode 1 - CT single word mode	56
Cautions	4	N	
Changing data rate	91	Network management objects (NMT)	88
Changing PDO mapping parameters	53	NMT commands	89
COB-ID EMCY	66	O	
COB-ID SYNC	65	Operating states	67
Communication profile objects	62	P	
Compliance with regulations	4	Parameter data object mapping	96
Configure bit timing	91	Parameters - adjusting	4
Configure node-ID	91	PDO data mapping errors	53
Control word	57	Pre-defined error field	64
Conversion factors	96	Process data object (PDO)	53
Current limit	60	Producer heartbeat time	67
D		Profile torque mode	103
Default parameters - restore	66	Profiles	53
Device	96	R	
Device profiles	96	Regenerating	60
DeviceNet ground point	11	Running at or below minimum speed	60
Drive active	60	RxPDO COB-ID	70
Dynamic brake active	60	RxPDO communication parameters	69
E		RxPDO event timer	71
Electrical safety	4	RxPDO event triggers	84
Emergency object	94	RxPDO inhibit time	71
Emergency object state	95	RxPDO mapping parameters	72
Emergency object state transitions	95	RxPDO transmission type	71
Enable DSP402 device profiles	96	RxPDO, SYNC and missed heartbeat event handling	78
Environmental limits	4	S	
Error register	64, 95	SDO abort codes	56
External power supply	10	Select product code	90
External supply	10	Select revision number	90
F		Select serial number	90
Flexible PDO numbering	68	Select vendor ID	90
G		Service data object (SDO)	55
General installation	9	Set-up flow chart	20
Generic EDS files	61	SI-DeviceNet cable shield connections	11
H		SI-DeviceNet connections	10
Hardware enable	57	Spurs	11
I		Status word	59
Identity object	67	Status word bit functions	60
L		Stored charge	4
Layer setting services (LSS)	89	Switch mode global	90
		Switch mode selective	90
		System design and safety of personnel	4

T

target_torque	103
Termination	11
torque_actual_value	103
torque_profile_type	104
torque_slope	104
TxPDO COB-ID	74
TxPDO communication parameters	73
TxPDO inhibit time	74
TxPDO mapping parameters	75
TxPDO number configuration	68
TxPDO transmission type	74

U

Unused PDO data channels	53
--------------------------------	----

V

Velocity mode objects	104
vl_control_effort	105
vl_velocity_acceleration	106
vl_velocity_deceleration	107
vl_velocity_demand	105
vl_velocity_min_max_amount	106

Z

Zero speed	60
------------------	----



0478-0101-01