



## *User Guide*

---

# **SI-PROFIBUS**

---

Part Number: 0478-0011-02  
Issue Number: 2



[www.controltechniques.com](http://www.controltechniques.com)

## General Information

The manufacturer accepts no liability for any consequences resulting from inappropriate, negligent or incorrect installation or adjustment of the optional parameters of the equipment or from mismatching the variable speed drive with the motor.

The contents of this guide are believed to be correct at the time of printing. In the interests of commitment to a policy of continuous development and improvement, the manufacturer reserves the right to change the specification of the product or its performance, or the content of the guide without notice.

All rights reserved. No parts of this guide may be reproduced or transmitted in any form or by any means, electrical or mechanical including, photocopying, recording or by an information storage or retrieval system, without permission in writing from the publisher.

## Environmental Statement

Control Techniques is committed to minimising the environmental impacts of its manufacturing operations and of its products throughout their life cycle. To this end, we operate an Environmental Management System (EMS) which is certified to the International Standard ISO 14001. Further information on the EMS, our Environment Policy and other relevant information is available on request, or can be found at [www.greendrives.com](http://www.greendrives.com).

The electronic variable speed drives manufactured by Control Techniques have the potential to save energy and (through increased machine/process efficiency) reduce raw material consumption and scrap throughout their long working lifetime. In typical applications, these positive environmental effects far outweigh the negative impacts of product manufacture and end-of-life disposal.

Nevertheless, when the products eventually reach the end of their useful life, they must not be discarded but should instead be recycled by a specialist recycler of electronic equipment. Recyclers will find the products easy to dismantle into their major component parts for efficient recycling. Many parts snap together and can be separated without the use of tools, while other parts are secured with conventional fasteners. Virtually all parts of the product are suitable for recycling.

Product packaging is of good quality and can be re-used. Large products are packed in wooden crates, while smaller products come in strong cardboard cartons which themselves have a high-recycled fibre content. If not re-used, these containers can be recycled. Polythene, used on the protective film and bags from wrapping product, can be recycled in the same way. Control Techniques' packaging strategy prefers easily recyclable materials of low environmental impact, and regular reviews identify opportunities for improvement.

When preparing to recycle or dispose of any product or packaging, please observe local legislation and best practice.

## Software Statement

This option module is supplied with the latest software version. When retro-fitting to an existing system, all software versions should be verified to confirm the same functionality as option modules of the same type already present. This also applies to products returned from a Control Techniques Service Centre or Repair Centre. If there is any doubt please contact the supplier of the product.

The software version of the option module can be identified by looking at Pr **MM.002** where **MM** is the relevant menu number for the option module slot being used. See Pr **MM.002** description later in this manual for more information. The software version takes the form of **ww.xx.yy.zz** seen in **MM.002**.

## REACH legislation

EC Regulation 1907/2006 on the Registration, Evaluation, Authorisation and restriction of Chemicals (REACH) requires the supplier of an article to inform the recipient if it contains more than a specified proportion of any substance which is considered by the European Chemicals Agency (ECHA) to be a Substance of Very High Concern (SVHC) and is therefore listed by them as a candidate for compulsory authorisation.

For current information on how this requirement applies in relation to specific Control Techniques products, please approach your usual contact in the first instance. Control Techniques position statement can be viewed at:

<http://www.controltechniques.com/REACH>

---

# Contents

---

<b>1</b>	<b>Safety information</b>	<b>5</b>
1.1	Warnings, Cautions and Notes	5
1.2	Electrical safety - general warning	5
1.3	System design and safety of personnel	5
1.4	Environmental limits	6
1.5	Access	6
1.6	Fire protection	6
1.7	Compliance with regulations	6
1.8	Adjusting parameters	6
1.9	Stored charge	6
<b>2</b>	<b>Introduction</b>	<b>7</b>
2.1	What is PROFIBUS-DP?	7
2.2	About SI-PROFIBUS	9
2.3	General specification	9
2.4	Option module identification	10
2.5	Conventions used in this guide	10
<b>3</b>	<b>Mechanical installation</b>	<b>11</b>
3.1	General Installation	11
<b>4</b>	<b>Electrical installation</b>	<b>12</b>
4.1	Terminal descriptions	12
4.2	SI-PROFIBUS connectors	13
4.3	SI-PROFIBUS cable	13
4.4	Cable shielding	13
4.5	General grounding considerations	13
4.6	Network termination	13
4.7	Maximum network length / device loading	14
4.8	Node addressing	14
4.9	Spurs	14
4.10	Minimum node to node cable length	14
4.11	Grounding	14
<b>5</b>	<b>Getting started</b>	<b>15</b>
5.1	Conventions used in this guide	15
5.2	Set-up flow chart	16
5.3	Single line descriptions	17
<b>6</b>	<b>Parameters</b>	<b>23</b>
6.1	Menus	23
6.2	Module menu 1 - PROFIBUS Setup	26
6.3	Module menu 2 - Input Mapping	38
6.4	Module menu 3 - Output Mapping	39
6.5	Module menu 4 - Fault Values	40
6.6	Module menu 9 - Resources	41
<b>7</b>	<b>GSD Files</b>	<b>42</b>
7.1	What are GSD Files?	42
7.2	Data consistency	42
7.3	Data configuration	42
7.4	GSD compatibility	43
7.5	GSD compatibility table	43

<b>8</b>	<b>Cyclic data</b> .....	<b>44</b>
8.1	What is cyclic data? .....	44
8.2	Data formats .....	44
8.3	Mapping conflicts .....	46
8.4	Cyclic data mapping errors .....	46
8.5	Mapping limitations .....	46
8.6	Disabling mappings .....	47
8.7	Master configuration .....	47
<b>9</b>	<b>Non-cyclic data</b> .....	<b>48</b>
9.1	What is non-cyclic data? .....	48
9.2	Configuration using non-cyclic data .....	48
9.3	SI-PROFIBUS overview .....	48
<b>10</b>	<b>Control and status words</b> .....	<b>51</b>
10.1	What are control and status words? .....	51
10.2	Control word .....	51
10.3	Status word .....	53
<b>11</b>	<b>Diagnostics</b> .....	<b>56</b>
11.1	Overview .....	56
11.2	Drive trip display codes .....	56
<b>12</b>	<b>PROFdrive profile (V4)</b> .....	<b>61</b>
12.1	What is PROFdrive profile? .....	61
12.2	Standard Telegram 1 .....	61
12.3	Main Setpoint .....	62
12.4	Main Actual Value .....	62
12.5	PROFdrive (V4) State Machine .....	63
12.6	Normal Run Sequence .....	63
12.7	Stopping the motor using PROFdrive .....	67
12.8	Jogging .....	67
12.9	PROFdrive control word .....	68
12.10	PROFdrive status word .....	69
12.11	PROFdrive PNU access .....	71
12.12	Fault Buffer .....	72
12.13	Drive Identification .....	74
12.14	Identification and Maintenance Functions .....	74
<b>13</b>	<b>Advanced features</b> .....	<b>75</b>
13.1	SYNC and FREEZE Mode .....	75
13.2	Inter-option communication timing .....	75
13.3	Multi-master operation .....	75
<b>14</b>	<b>Legacy features</b> .....	<b>76</b>
14.1	Network compatibility mode .....	76
14.2	PPO Types .....	77
14.3	Configuring the Profile .....	79
14.4	Setting the non-cyclic mode (non-cyclic over cyclic) .....	79
14.5	Mode 1 - CT Single Word mode .....	79
14.6	Reading parameters using CT Single Word .....	81
14.7	Mode 2 - PPO 4 Word mode .....	90
<b>15</b>	<b>Glossary of terms</b> .....	<b>97</b>

# 1 Safety information

## 1.1 Warnings, Cautions and Notes



A **Warning** contains information, which is essential for avoiding a safety hazard.



A **Caution** contains information, which is necessary for avoiding a risk of damage to the product or other equipment.

**NOTE** A **Note** contains information, which helps to ensure correct operation of the product.

## 1.2 Electrical safety - general warning

The voltages used in the drive can cause severe electrical shock and/or burns, and could be lethal. Extreme care is necessary at all times when working with or adjacent to the drive.

Specific warnings are given at the relevant places in this User Guide.

## 1.3 System design and safety of personnel

The drive is intended as a component for professional incorporation into complete equipment or a system. If installed incorrectly, the drive may present a safety hazard.

The drive uses high voltages and currents, carries a high level of stored electrical energy, and is used to control equipment which can cause injury.

Close attention is required to the electrical installation and the system design to avoid hazards either in normal operation or in the event of equipment malfunction. System design, installation, commissioning/start-up and maintenance must be carried out by personnel who have the necessary training and experience. They must read this safety information and this User Guide carefully.

The STOP and SAFE TORQUE OFF functions of the drive do not isolate dangerous voltages from the output of the drive or from any external option unit. The supply must be disconnected by an approved electrical isolation device before gaining access to the electrical connections.

**With the sole exception of the SAFE TORQUE OFF function, none of the drive functions must be used to ensure safety of personnel, i.e. they must not be used for safety-related functions.**

Careful consideration must be given to the functions of the drive which might result in a hazard, either through their intended behavior or through incorrect operation due to a fault. In any application where a malfunction of the drive or its control system could lead to or allow damage, loss or injury, a risk analysis must be carried out, and where necessary, further measures taken to reduce the risk - for example, an over-speed protection device in case of failure of the speed control, or a fail-safe mechanical brake in case of loss of motor braking.

**The system designer is responsible for ensuring that the complete system is safe and designed correctly according to the relevant safety standards.**

## 1.4 Environmental limits

Instructions regarding transport, storage, installation and use of the drive must be complied with, including the specified environmental limits. These instructions can be found in the relevant drive documentation. Drives must not be subjected to excessive physical force.

## 1.5 Access

Drive access must be restricted to authorized personnel only. Safety regulations which apply at the place of use must be complied with.

## 1.6 Fire protection

The drive enclosure is not classified as a fire enclosure. A separate fire enclosure must be provided.

## 1.7 Compliance with regulations

The installer is responsible for complying with all relevant regulations, such as national wiring regulations, accident prevention regulations and electromagnetic compatibility (EMC) regulations. Particular attention must be given to the cross-sectional areas of conductors, the selection of fuses or other protection, and protective ground (earth) connections.

Instructions for achieving compliance with specific EMC standards may be found in the relevant drive documentation.

Within the European Union, all machinery in which this product is used must comply with the following directives:

2006/42/EC: Safety of machinery.

2004/108/EC: Electromagnetic Compatibility.

## 1.8 Adjusting parameters

Some parameters have a profound effect on the operation of the drive. They must not be altered without careful consideration of the impact on the controlled system. Measures must be taken to prevent unwanted changes due to error or tampering.

## 1.9 Stored charge

The drive contains capacitors which remain charged to a potentially lethal voltage after the AC supply has been disconnected. If the drive has been energized, the AC supply must be isolated for at least ten minutes before work may continue.

## 2 Introduction

### 2.1 What is PROFIBUS-DP?

PROFIBUS-DP (Decentralized Peripheral) is a networking system which falls into the generic category of fieldbus. Fieldbuses are generally defined as industrial networking systems that are intended to replace traditional wiring systems. Figure 2-1 shows the traditional cabling requirements to transfer signals between 2 slaves and a master.

**Figure 2-1 Traditional cable layout**

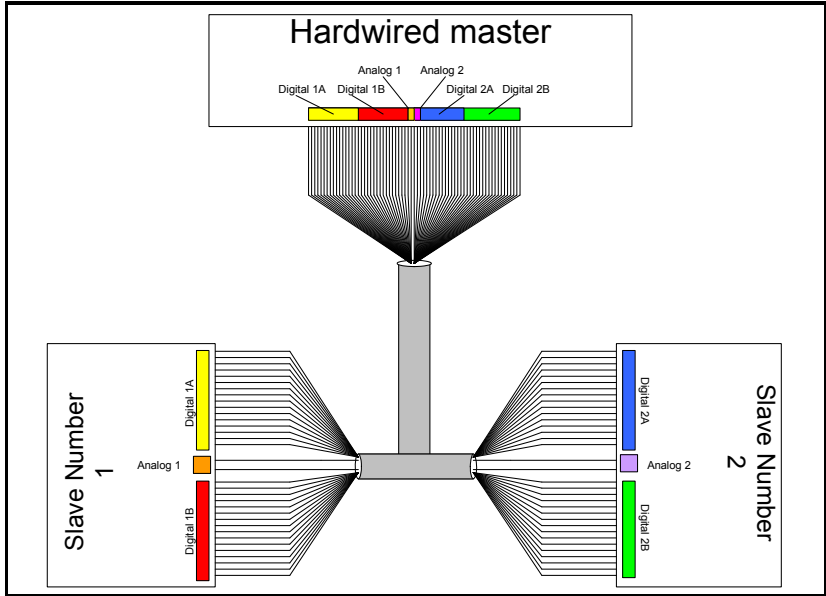


Table 2.1 details how the wiring is used to communicate data between the master and the slaves. Each signal that is communicated requires one signal wire giving a total of 66 signal wires plus a 0V return.

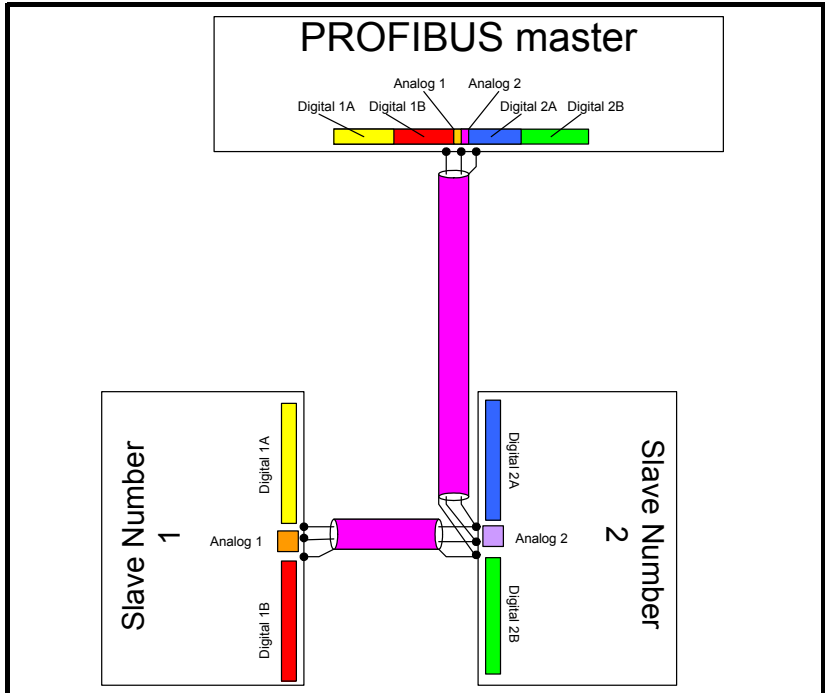
**Table 2.1 Traditional wiring details**

Number of signals	Type	Source / Destination	Description
16	digital Inputs	slave 1 to master	status signals
	digital outputs	master to slave 1	control signals
1	analog output	master to slave 1	control signal
16	digital inputs	slave 2 to master	status signals
	digital outputs	master to slave 2	control signals
1	analog output	master to slave 2	control signal

A fieldbus topology such as PROFIBUS-DP allows the same configuration to be realized using only two signal wires plus a shield. This method of communication saves significantly on the amount of cabling required and can improve overall system reliability as the number of interconnections is greatly reduced.

Figure 2-2 shows a typical PROFIBUS-DP network system transferring the same signals as given in the traditionally wired example. The signals are now transmitted by converting them into a serial data stream which is received by the master as if they were connected using traditional wiring. The data stream on PROFIBUS-DP allows up to 64 (32 input and 32 output) independent values to be sent or received by the master, in addition to a single channel allowing for random access to drive parameters.

**Figure 2-2 PROFIBUS-DP cable layout**



**Table 2.2 Data mappings for SI-PROFIBUS**

Number of network words	Type	Source / Destination	Description
1	digital Inputs	slave 1 to master	status signals
	digital outputs	master to slave 1	control signals
	analog output		control signal
	digital inputs	slave 2 to master	status signals
	digital outputs	master to slave 2	control signals
	analog output		control signal

Table 2.2 details the number of data words used to communicate the signals using the PROFIBUS-DP network. It can be seen that the resulting reduction in cabling is significant.



PROFIBUS-DP can transfer data using two distinct modes. The first of these modes is cyclic, where signals are sent in predefined blocks at regular intervals. This is the equivalent of the hard-wired example in Figure 2-1.

The second method of transfer is called non-cyclic data, and is used for sending values that only need to be changed occasionally or where the source or destination of the signal changes. This is the equivalent of a temporary patch lead that is removed after use.

## 2.2 About SI-PROFIBUS

SI-PROFIBUS is a fieldbus option module that can be installed to the expansion slot(s) in any of the following drives to provide PROFIBUS-DP slave connectivity:

- Unidrive M

It is possible to use more than one SI-PROFIBUS or a combination of SI-PROFIBUS and other option modules to add additional functionality such as extended I/O, gateway functionality, or additional PLC features.

**Figure 2-3 SI-PROFIBUS module**



## 2.3 General specification

### 2.3.1 Features

The following section gives a brief overview of the functionality available within SI-PROFIBUS.

- Supported data rates (bits/s): 12M, 6.0M, 3.0M, 1.5M, 500k, 187.5k, 93.75k, 45.45k, 19.2k, 9.6k.
- Maximum of 32 input and 32 output cyclic data words supported
- PROFdrive profile (V4) supported
- Non-cyclic data channel supported
- Parallel acyclic/cyclic data communication

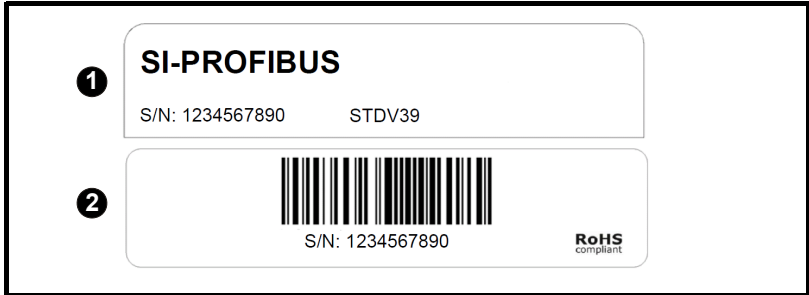
The SI-PROFIBUS is powered from the host drive's internal power supply.

## 2.4 Option module identification

The SI-PROFIBUS can be identified by:

1. The label located on the underside of the Option module.
2. The color coding across the front of the SI-PROFIBUS (purple).

**Figure 2-4 SI-PROFIBUS labels**



1 Topside module label

2 Underside module label

### 2.4.1 Date code format

The date code is split into two sections: a letter followed by a number. The letter indicates the year, and the number indicates the week number (within the year) in which the Option Module was built. The letters go in alphabetical order, starting with A in 1990 (B in 1991, C in 1992 etc).

**Example:**

A date code of V35 would correspond to week 35 of year 2012.

### 2.4.2 Back-up power supply

The required drive can be connected to a 24V dc back-up power supply (terminals 1 and 2). This keeps the control electronics and option module powered up, allowing the SI-PROFIBUS to continue communicating with the PROFIBUS-DP master controller when the main supply to the drive is switched off. For every SI-PROFIBUS installed allow for an extra 70 mA of supply current to be drawn from the back-up supply.

## 2.5 Conventions used in this guide

The configuration of the host drive and Option Module is done using menus and parameters. A menu is a logical collection of parameters that have similar functionality.

In the case of an Options Module, the parameters will appear in menu 15, 16 or 17 depending on which slot the module is installed to. The menu is determined by the number before the decimal point.

The method used to determine the menu or parameter is as follows:

- Pr **S.mm.ppp** - Where S signifies the Option module slot number and mm.ppp signifies the menu and parameter number of the Option module's internal menus and parameters.
- Pr **MM.ppp** - Where MM signifies the menu allocated to the Option module set-up menu and ppp signifies the parameter number.
- Pr **mm.000** - Signifies parameter number 000 in any drive menu.

# 3 Mechanical installation

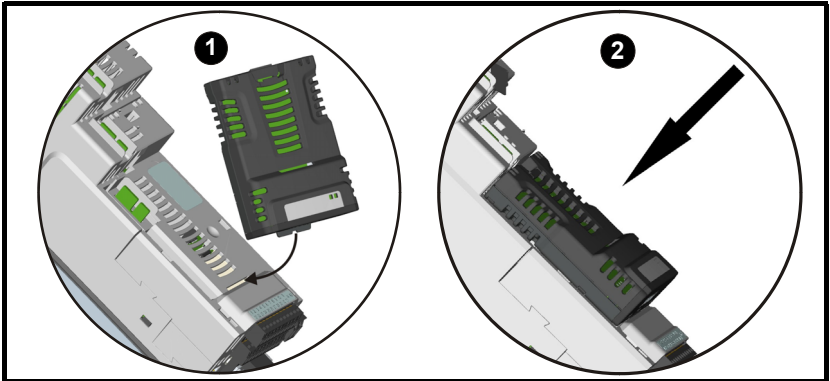


Before installing or removing an Option module from any drive, ensure the AC supply has been disconnected for at least 10 minutes and refer to section 1 *Safety information* on page 5. If using a DC bus supply ensure this is fully discharged before working on any drive or Option module.

## 3.1 General Installation

The installation of Option modules is illustrated in Figure 3-1 and Figure 3-2.

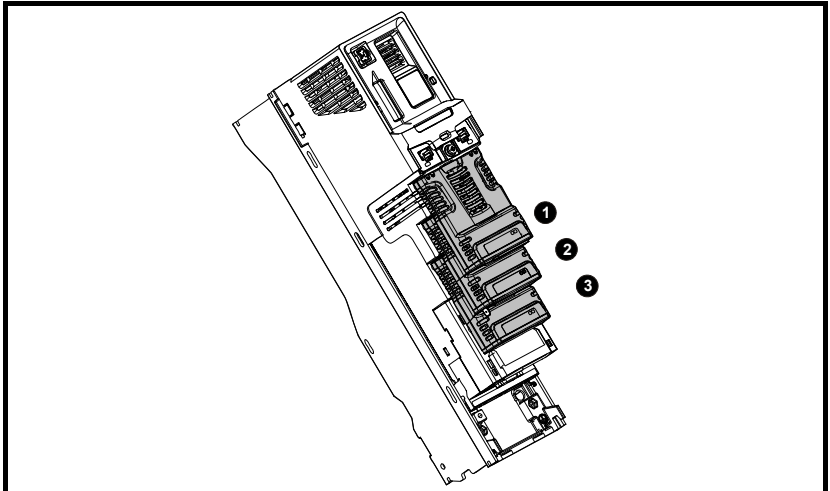
**Figure 3-1 Installing an Option module**



### 3.1.1 Installing the first Option module

- Option module slots must be used in the following order: slot 3, slot 2 and slot 1.
- Orientate the Option module above the drive as shown in (1).
- Align and insert the Option module tab into the slot (2). Press down on the Option module until it clicks into place.

**Figure 3-2 Option module order of installation**



Adding Option modules: Populate slot **3** first, then slot **2** and finally slot **1**

Safety information
Introduction
<b>Mechanical installation</b>
Electrical installation
Getting started
Parameters
GSD Files
Cyclic data
Non-cyclic data
Control and status words
Diagnostics
PROFdrive profile (V4)
Advanced features
Legacy features
Glossary of terms
Index

## 4 Electrical installation

### 4.1 Terminal descriptions

SI-PROFIBUS has a standard 9-way female D-type connector for the PROFIBUS-DP network.

Figure 4-1 SI-PROFIBUS terminals

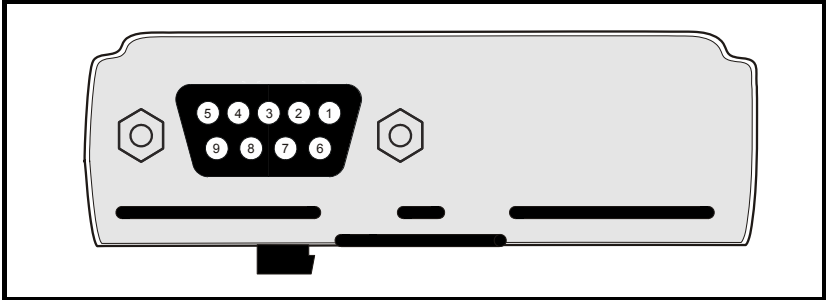
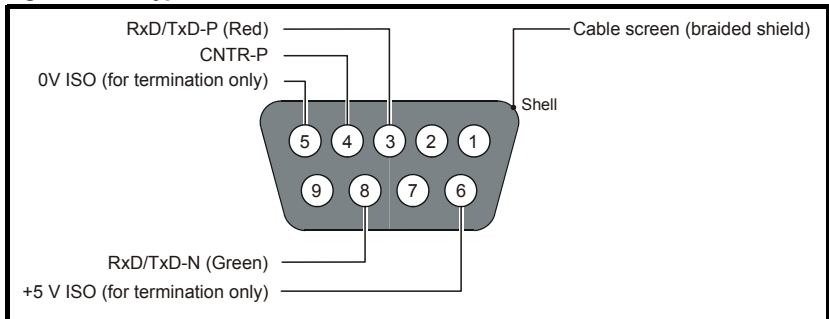


Table 4.1 SI-PROFIBUS D-Type pin out

D-type Terminal	Function	Description
3	RxD/TxD-P	Positive data line (B) - Red
8	RxD/TxD-N	Negative data line (A) - Green
6	+ 5V ISO	+5 V isolated, use only for termination resistors
5	0V ISO	0 V isolated, use only for termination resistors
4	CNTR-P	RTS line
1, Shell	Shield	Cable shield connection

Figure 4-2 D-Type connections



Control Techniques recommend using connectors approved by PROFIBUS International at all times.

## 4.2 SI-PROFIBUS connectors

There are numerous manufacturers of SI-PROFIBUS connectors. Always ensure that any connectors used on the network are fully approved for use with SI-PROFIBUS. Some of the connector types available include built in termination that allows the network to be isolated, this can be very useful when fault finding. For data rates above 1.5Mbs connectors installed with integrated inductors should be used.

## 4.3 SI-PROFIBUS cable

PROFIBUS-DP networks can run at high data rates and require cable specifically designed to carry high frequency signals. Low quality cable will attenuate the signals, and may render the signal unreadable for the other nodes on the network. Cable specifications and a list of approved manufacturers of cable for use on PROFIBUS-DP networks are available on the PROFIBUS Nutzerorganisation (PNO) web site at [www.profibus.com](http://www.profibus.com).

**NOTE**

Control Techniques can only guarantee correct and reliable operation of the SI-PROFIBUS if all other equipment on the PROFIBUS-DP network (including the network cable) has been approved by the PNO and is correctly installed.

## 4.4 Cable shielding

Correct shielding of the PROFIBUS-DP cable is required for reliable operation at high data rates, this can be achieved by exposing the cable shield of each PROFIBUS-DP cable and ensuring that they are clamped to the drive grounding metalwork as close as possible to the drive termination, contact your supplier or local Control Techniques Drive Centre for more information.

**NOTE**

Unless there are specific reasons for not grounding the network it is recommended that all drive network connections are correctly grounded. Failure to do so may reduce the noise immunity of the system. If there are specific issues with grounding, alternative methods of connection should be considered such as the use of fibre optic cable.

## 4.5 General grounding considerations

It is essential that good grounding is provided not only for network stability but more importantly electrical safety. In all instances electrical regulations should be adhered to. As a guide the network cable should be grounded at least once per cabinet, ideally on each drive.

## 4.6 Network termination

It is very important in high-speed communications networks that the network communications cable is installed with the specified termination resistor network at each end of each segment. This prevents signals from being reflected back down the cable and causing interference.

Most ranges of connectors provide specific parts that incorporate the termination network. Such connectors derive the power from the host device and if the host device is switched off the termination will be lost. To avoid this situation a separate termination device is available that is powered independently of the network devices. For more information go to [www.profibus.com](http://www.profibus.com).

**NOTE**

Failure to terminate a network correctly can seriously affect the operation of the network. If the correct termination networks are not installed, the noise immunity of the network is greatly reduced. Each network segment must be correctly terminated.

## 4.7 Maximum network length / device loading

The maximum number of devices that can be connected to a single PROFIBUS-DP network segment is 32, this includes all nodes and any repeaters. The maximum lengths of cable for a segment depend on the data rate and are shown in Table 4.2.

Repeaters or fiber optic segments can be used to extend the network, allowing more than 32 nodes to be connected on the network. The maximum number of nodes on a single network is 125.

**NOTE** For full details on designing and installing a PROFIBUS-DP network, refer to *Installation Guidelines for PROFIBUS-DP/FMS*. This document is available from the PROFIBUS web site at [www.profibus.com](http://www.profibus.com).

**Table 4.2 PROFIBUS-DP maximum network cable lengths**

Data rate (bits/s)	Maximum trunk length (m)
12M	100
6.0M	100
3.0M	100
1.5M	200
500k	400
187.5k	1000
93.75k	1200
45.45k	1200
19.2k	1200
9.6K	1200

## 4.8 Node addressing

SI-PROFIBUS has a valid address range of 1 to 125. Addresses 126 and 0 are reserved for system use and should not be used. The addressing scheme used is at the discretion of the end user however it is recommended that nodes are numbered in order as they appear on the physical network. It is not necessary to use consecutive numbers and gaps in the addressing scheme may be left to allow for future expansion.

## 4.9 Spurs

The PROFIBUS-DP specification allows spurs at data rates less than 1.5 Mb/s. At data rates below 1.5 Mb/s there are specific requirements for capacitance and length of cable allowed when using spurs. Control Techniques recommend that spurs are not used as extreme care is required at the design stage to avoid network problems. More information on spurs can be found on the PROFIBUS web site at [www.profibus.com](http://www.profibus.com).

## 4.10 Minimum node to node cable length

The minimum recommended node to node distance is one metre of network cable. This distance is necessary to avoid multiple nodes generating a single large reflection on the network, using less than one metre of cable between nodes can have serious implications for network reliability.

## 4.11 Grounding

Refer to the relevant *Drive User Guide* for more information.

# 5 Getting started

This section is intended to provide a generic guide for configuring SI-PROFIBUS with a master controller. Figure 5-1 is intended as a basic guide, but it does detail the stages that are required to achieve a functioning network. It is recommended that all of this chapter is read, before attempting to configure a system.

**NOTE** Due to the large number of PLCs/masters that support PROFIBUS-DP, only generic details can be provided. Support is available through your supplier or local Control Techniques Drive Centre.

**NOTE** Before contacting your supplier or local Control Techniques Drive Centre for support, please read of this manual to check that you have configured all parameters correctly. Before calling, please ensure you have the following information readily to hand:

- A list of all parameters in SI-PROFIBUS.
- The drive firmware version (*see the relevant drive user guide*).
- The SI-PROFIBUS firmware version.

## 5.1 Conventions used in this guide

The configuration of the host drive and option module is done using menus and parameters. A menu is a logical collection of parameters that have similar functionality. In the case of an option module, the parameters relating to the setup of the option module will appear in menu 15, 16 or 17 depending on which slot the module is installed in and the setup of the Option slot identifiers (Pr **11.056**); the internal menus of the option module will appear before menu 0 and after menu 41.

The method used to determine the menu or parameter is as follows:

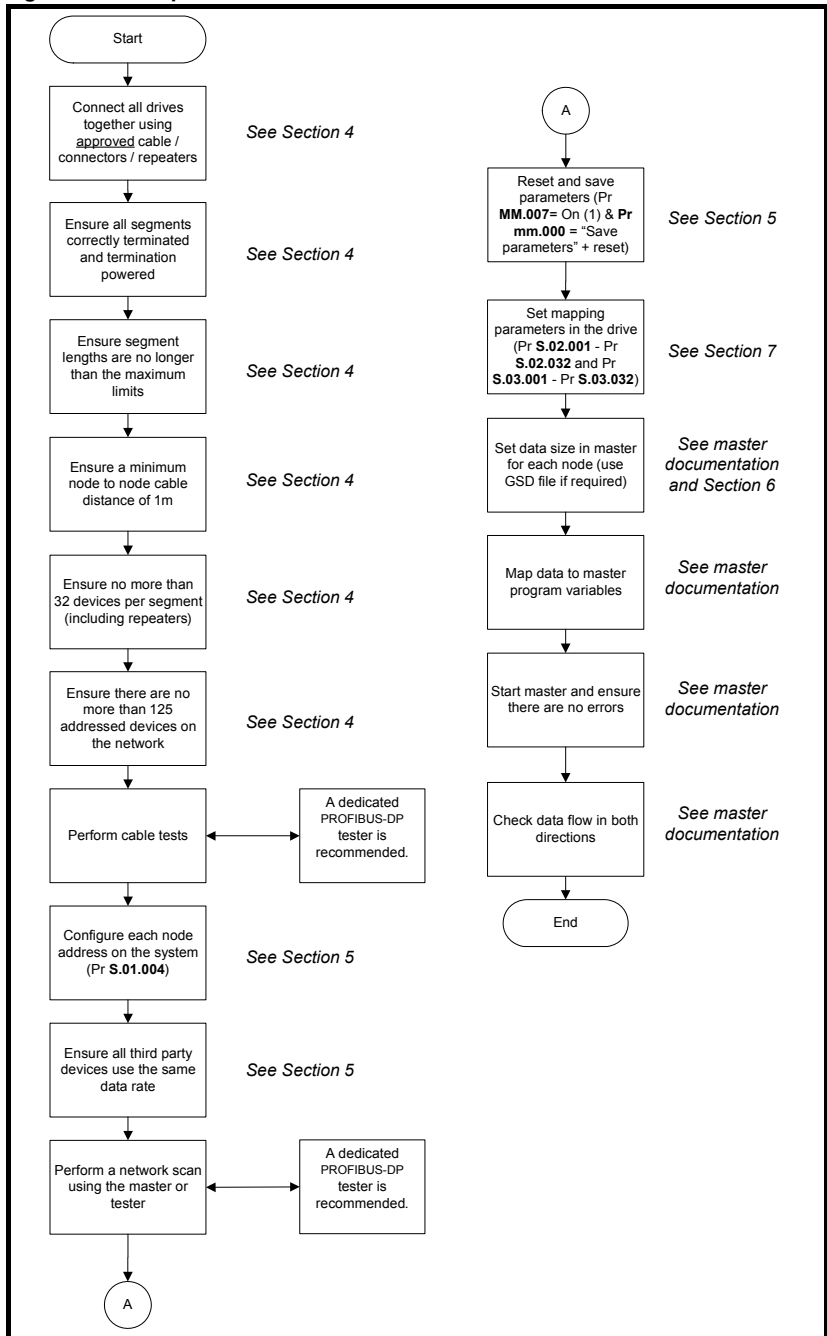
- Pr **S.mm.ppp** - Where S signifies the option module slot number and mm.ppp signifies the menu and parameter number of the option module's internal menus and parameters.
- Pr **MM.ppp** - Where MM signifies the menu allocated to the option module set-up menu and ppp signifies the parameter number.
- Pr **mm.000** - Signifies parameter number 000 in any drive menu.

Safety information
Introduction
Mechanical installation
Electrical installation
<b>Getting started</b>
Parameters
GSD Files
Cyclic data
Non-cyclic data
Control and status words
Diagnostics
PROFIBUS profile (V4)
Advanced features
Legacy features
Glossary of terms
Index

## 5.2

# Set-up flow chart

Figure 5-1 Set-up flow chart





## 5.3 Single line descriptions

### 5.3.1 Menu 0 - Setup

Table 5.1 Menu 0 single line descriptions

Parameter	Range(†)	Default(⇒)	Type						
S.00.001	Module ID	0 to 65535	443	RO	Num	ND	NC	PT	
S.00.002	Firmware Version	00.00.00.00 to 99.99.99.99		RO	Num	ND	NC	PT	
S.00.003	Hardware Version	00.00 to 99.99		RO	Num	ND	NC	PT	
S.00.004	Serial Number LS	0 to 99999999		RO	Num	ND	NC	PT	
S.00.005	Serial Number MS	0 to 99999999		RO	Num	ND	NC	PT	
S.00.006	Module status	Initializing (0), Ok (1), Config (2), Error (3)		RO	Num	ND	NC	PT	
S.00.007	Module reset	Off (0) or On (1)	Off (0)	RW	Bit		NC		
S.00.008	Module default	Off (0) or On (1)	Off (0)	RW	Bit		NC		

Menu 0 within the Option Module, is also displayed in the drive menu 15, 16 or 17 depending on which slot the Option Module is installed to. However, the functionality of all parameters remains the same.

#### NOTE

Menu 0 is not available in firmware version 01.01.01.02 and previous versions.

### 5.3.2 Menu 1 - PROFIBUS setup

Parameter	Range(†)	Default(⇒)	Type						
S.01.001	Enable Profibus Interface	Off (0) or On (1)	On (1)	RO	Bit				
S.01.002	Reset Profibus Interface	Off (0) or On (1)	Off (0)	RW	Bit				
S.01.003	Default Profibus Interface	Off (0) or On (1)	Off (0)	RW	Bit				
S.01.004	Profibus node address	0 to 126	126	RW	Num				US
S.01.005	Baud rate	Auto-detect (0), 12 Mbps (1), 6 Mbps (2), 3 Mbps (3), 1.5 Mbps (4), 500 kbps (5), 187.5 kbps (6), 93.75 kbps (7), 45.45 kbps (8), 19.2 kbps (9) 9.6 kbps (10)		RO	Txt	ND	NC	PT	
S.01.006	Profibus Network Diagnostic	Network OK (0), Initialization (1), Initialised(2), No network data (3), First failure (4), Second failure (5), Third Failure (6)		RO	Txt	ND	NC	PT	
S.01.007	Cyclic data transfers per second	0 to 9999 messages/s		RO	Num	ND	NC	PT	
S.01.008	Telegram selection	Auto (0), Custom (1), STD Tel 1 (2), STD Tel 1 + 6 (3), STD Tel 1 + 10 (4), PPO1 (5), PPO2 (6), PPO3 (7), PPO4 (8), PPO5 (9)	Custom (1)	RW	Txt				US
S.01.010	Timeout delay	0 to 3000 ms	200 ms	RW	Num				US

Parameter		Range(⇅)	Default(⇆)	Type						
S.01.011	Timeout action	Trip (0), Send fit values (1), Clear output (2), Hold last (3), No action (4)	Trip (0)	RW	Txt					US
S.01.012	Timeout event destination	This slot (0), Slot 1 (1), Slot 2 (2), Slot 3 (3), Slot 4 (4)	This slot (0)	RW	Txt					US
S.01.013	Timeout event type	No event (0), Event 0 (1), Event 1 (2), Event 2 (3), Event 3 (4), Event 4 (5)	No event (0)	RW	Txt					US
S.01.014	Data alignment	32 (0) or 16 (1) bits	32 (0) bits	RW	Txt					US
S.01.020	Number of Input cyclic words	1 to 32	4	RW	Num		NC	PT		US
S.01.021	Number of Output cyclic words	1 to 32	4	RW	Num		NC	PT		US
S.01.022	Input mapping status	No error (0), Too many IN objs (1), No mapping (2), Read mismatch (3), Hole in mappings (4), N-C mapping err (5), Duplicate error (6), Length mismatch (7), IN mode and PPO (8), Data align w PPO (9), No PPO support (10), SP A-D IN map (11), IN AND CTNC & PPO4 (12)		RO	Txt					
S.01.023	Output mapping status	No error (0), Mapping expected (1), No mapping (2), Write mismatch (3), Hole in mappings (4), N-C mapping err (5), Duplicate error (6), Length mismatch (7), OUT mode and PPO (8), Data align w PPO (9), No PPO support (10), SP A-D OUT map (11), OUT AND CTNC & PPO4 (12)		RO	Txt					
S.01.024	Input processing time	0 to 65535 ms		RO	Num	ND				
S.01.025	Output processing time	0 to 65535 ms		RO	Num	ND				
S.01.026	Input consistency	Off (0) or On (1)	Off (0)	RW	Txt					US
S.01.027	Input consistency trigger	0.00.000 to 4.99.999	0.00.000	RW	Num					US
S.01.028	Output consistency	Off (0) or On (1)	Off (0)	RW	Txt					US
S.01.029	Output consistency trigger	0.00.000 to 4.99.999	0.00.000	RW	Txt					US
S.01.030	Non-cyclic over cyclic	None (0), CTNC (1), PPO defined (2)	None (0)	RW	Txt					US
S.01.031	Compatibility mode	Auto-detect (0), Unidrive M (1), UniSP (2), UniSP extended (3)	Auto-detect (0)	RW	Txt					US

### 5.3.3 Menu 2 - Input mapping

Parameter		Range(†)	Default(⇒)	Type					
S.02.001	Input source 1	0 to 5.01.004	0.10.040	RW	Num	DE		PT	US
S.02.002	Input source 2	0 to 5.01.004	0.02.001	RW	Num	DE		PT	US
S.02.003	Input source 3	0 to 5.01.004	0.00.000	RW	Num	DE		PT	US
S.02.004	Input source 4	0 to 5.01.004	0.00.000	RW	Num	DE		PT	US
S.02.005	Input source 5	0 to 5.01.004	0.00.000	RW	Num	DE		PT	US
S.02.006	Input source 6	0 to 5.01.004	0.00.000	RW	Num	DE		PT	US
S.02.007	Input source 7	0 to 5.01.004	0.00.000	RW	Num	DE		PT	US
S.02.008	Input source 8	0 to 5.01.004	0.00.000	RW	Num	DE		PT	US
S.02.009	Input source 9	0 to 5.01.004	0.00.000	RW	Num	DE		PT	US
S.02.010	Input source 10	0 to 5.01.004	0.00.000	RW	Num	DE		PT	US
S.02.011	Input source 11	0 to 5.01.004	0.00.000	RW	Num	DE		PT	US
S.02.012	Input source 12	0 to 5.01.004	0.00.000	RW	Num	DE		PT	US
S.02.013	Input source 13	0 to 5.01.004	0.00.000	RW	Num	DE		PT	US
S.02.014	Input source 14	0 to 5.01.004	0.00.000	RW	Num	DE		PT	US
S.02.015	Input source 15	0 to 5.01.004	0.00.000	RW	Num	DE		PT	US
S.02.016	Input source 16	0 to 5.01.004	0.00.000	RW	Num	DE		PT	US
S.02.017	Input source 17	0 to 5.01.004	0.00.000	RW	Num	DE		PT	US
S.02.018	Input source 18	0 to 5.01.004	0.00.000	RW	Num	DE		PT	US
S.02.019	Input source 19	0 to 5.01.004	0.00.000	RW	Num	DE		PT	US
S.02.020	Input source 20	0 to 5.01.004	0.00.000	RW	Num	DE		PT	US
S.02.021	Input source 21	0 to 5.01.004	0.00.000	RW	Num	DE		PT	US
S.02.022	Input source 22	0 to 5.01.004	0.00.000	RW	Num	DE		PT	US
S.02.023	Input source 23	0 to 5.01.004	0.00.000	RW	Num	DE		PT	US
S.02.024	Input source 24	0 to 5.01.004	0.00.000	RW	Num	DE		PT	US
S.02.025	Input source 25	0 to 5.01.004	0.00.000	RW	Num	DE		PT	US
S.02.026	Input source 26	0 to 5.01.004	0.00.000	RW	Num	DE		PT	US
S.02.027	Input source 27	0 to 5.01.004	0.00.000	RW	Num	DE		PT	US
S.02.028	Input source 28	0 to 5.01.004	0.00.000	RW	Num	DE		PT	US
S.02.029	Input source 29	0 to 5.01.004	0.00.000	RW	Num	DE		PT	US
S.02.030	Input source 30	0 to 5.01.004	0.00.000	RW	Num	DE		PT	US
S.02.031	Input source 31	0 to 5.01.004	0.00.000	RW	Num	DE		PT	US
S.02.032	Input source 32	0 to 5.01.004	0.00.000	RW	Num	DE		PT	US

Safety information
Introduction
Mechanical installation
Electrical installation
Getting started
Parameters
GSD Files
Cyclic data
Non-cyclic data
Control and status words
Diagnostics
PROFuture profile (V4)
Advanced features
Legacy features
Glossary of terms
Index

### 5.3.4 Menu 3 - Output mapping

Menu		Range(Ɽ)	Default(⇒)	Type					
S.03.001	Output destination 1	0 to 5.01.004	0.06.042	RW	Num	DE		PT	US
S.03.002	Output destination 2	0 to 5.01.004	0.01.021	RW	Num	DE		PT	US
S.03.003	Output destination 3	0 to 5.01.004	0.00.000	RW	Num	DE		PT	US
S.03.004	Output destination 4	0 to 5.01.004	0.00.000	RW	Num	DE		PT	US
S.03.005	Output destination 5	0 to 5.01.004	0.00.000	RW	Num	DE		PT	US
S.03.006	Output destination 6	0 to 5.01.004	0.00.000	RW	Num	DE		PT	US
S.03.007	Output destination 7	0 to 5.01.004	0.00.000	RW	Num	DE		PT	US
S.03.008	Output destination 8	0 to 5.01.004	0.00.000	RW	Num	DE		PT	US
S.03.009	Output destination 9	0 to 5.01.004	0.00.000	RW	Num	DE		PT	US
S.03.010	Output destination 10	0 to 5.01.004	0.00.000	RW	Num	DE		PT	US
S.03.011	Output destination 11	0 to 5.01.004	0.00.000	RW	Num	DE		PT	US
S.03.012	Output destination 12	0 to 5.01.004	0.00.000	RW	Num	DE		PT	US
S.03.013	Output destination 13	0 to 5.01.004	0.00.000	RW	Num	DE		PT	US
S.03.014	Output destination 14	0 to 5.01.004	0.00.000	RW	Num	DE		PT	US
S.03.015	Output destination 15	0 to 5.01.004	0.00.000	RW	Num	DE		PT	US
S.03.016	Output destination 16	0 to 5.01.004	0.00.000	RW	Num	DE		PT	US
S.03.017	Output destination 17	0 to 5.01.004	0.00.000	RW	Num	DE		PT	US
S.03.018	Output destination 18	0 to 5.01.004	0.00.000	RW	Num	DE		PT	US
S.03.019	Output destination 19	0 to 5.01.004	0.00.000	RW	Num	DE		PT	US
S.03.020	Output destination 20	0 to 5.01.004	0.00.000	RW	Num	DE		PT	US
S.03.021	Output destination 21	0 to 5.01.004	0.00.000	RW	Num	DE		PT	US
S.03.022	Output destination 22	0 to 5.01.004	0.00.000	RW	Num	DE		PT	US
S.03.023	Output destination 23	0 to 5.01.004	0.00.000	RW	Num	DE		PT	US
S.03.024	Output destination 24	0 to 5.01.004	0.00.000	RW	Num	DE		PT	US
S.03.025	Output destination 25	0 to 5.01.004	0.00.000	RW	Num	DE		PT	US
S.03.026	Output destination 26	0 to 5.01.004	0.00.000	RW	Num	DE		PT	US
S.03.027	Output destination 27	0 to 5.01.004	0.00.000	RW	Num	DE		PT	US
S.03.028	Output destination 28	0 to 5.01.004	0.00.000	RW	Num	DE		PT	US

Menu		Range(⊕)	Default(⇔)	Type					
S.03.029	Output destination 29	0 to 5.01.004	0.00.000	RW	Num	DE		PT	US
S.03.030	Output destination 30	0 to 5.01.004	0.00.000	RW	Num	DE		PT	US
S.03.031	Output destination 31	0 to 5.01.004	0.00.000	RW	Num	DE		PT	US
S.03.032	Output destination 32	0 to 5.01.004	0.00.000	RW	Num	DE		PT	US

### 5.3.5 Menu 4 - Fault values

Parameter		Range(⊕)	Default(⇔)	Type					
S.04.001	Fault value 1	$-2^{31}$ to $2^{31}-1$	0	RW	Num				US
S.04.002	Fault value 2	$-2^{31}$ to $2^{31}-1$	0	RW	Num				US
S.04.003	Fault value 3	$-2^{31}$ to $2^{31}-1$	0	RW	Num				US
S.04.004	Fault value 4	$-2^{31}$ to $2^{31}-1$	0	RW	Num				US
S.04.005	Fault value 5	$-2^{31}$ to $2^{31}-1$	0	RW	Num				US
S.04.006	Fault value 6	$-2^{31}$ to $2^{31}-1$	0	RW	Num				US
S.04.007	Fault value 7	$-2^{31}$ to $2^{31}-1$	0	RW	Num				US
S.04.008	Fault value 8	$-2^{31}$ to $2^{31}-1$	0	RW	Num				US
S.04.009	Fault value 9	$-2^{31}$ to $2^{31}-1$	0	RW	Num				US
S.04.010	Fault value 10	$-2^{31}$ to $2^{31}-1$	0	RW	Num				US
S.04.011	Fault value 11	$-2^{31}$ to $2^{31}-1$	0	RW	Num				US
S.04.012	Fault value 12	$-2^{31}$ to $2^{31}-1$	0	RW	Num				US
S.04.013	Fault value 13	$-2^{31}$ to $2^{31}-1$	0	RW	Num				US
S.04.014	Fault value 14	$-2^{31}$ to $2^{31}-1$	0	RW	Num				US
S.04.015	Fault value 15	$-2^{31}$ to $2^{31}-1$	0	RW	Num				US
S.04.016	Fault value 16	$-2^{31}$ to $2^{31}-1$	0	RW	Num				US
S.04.017	Fault value 17	$-2^{31}$ to $2^{31}-1$	0	RW	Num				US
S.04.018	Fault value 18	$-2^{31}$ to $2^{31}-1$	0	RW	Num				US
S.04.019	Fault value 19	$-2^{31}$ to $2^{31}-1$	0	RW	Num				US
S.04.020	Fault value 20	$-2^{31}$ to $2^{31}-1$	0	RW	Num				US
S.04.021	Fault value 21	$-2^{31}$ to $2^{31}-1$	0	RW	Num				US
S.04.022	Fault value 22	$-2^{31}$ to $2^{31}-1$	0	RW	Num				US
S.04.023	Fault value 23	$-2^{31}$ to $2^{31}-1$	0	RW	Num				US

Safety information
Introduction
Mechanical installation
Electrical installation
Getting started
Parameters
GSD Files
Cyclic data
Non-cyclic data
Control and status words
Diagnostics
PROFuture profile (V4)
Advanced features
Legacy features
Glossary of terms
Index

Parameter		Range(⇅)	Default(⇔)	Type					
<b>S.04.024</b>	Fault value 24	$-2^{31}$ to $2^{31}-1$	0	RW	Num				US
<b>S.04.025</b>	Fault value 25	$-2^{31}$ to $2^{31}-1$	0	RW	Num				US
<b>S.04.026</b>	Fault value 26	$-2^{31}$ to $2^{31}-1$	0	RW	Num				US
<b>S.04.027</b>	Fault value 27	$-2^{31}$ to $2^{31}-1$	0	RW	Num				US
<b>S.04.028</b>	Fault value 28	$-2^{31}$ to $2^{31}-1$	0	RW	Num				US
<b>S.04.029</b>	Fault value 29	$-2^{31}$ to $2^{31}-1$	0	RW	Num				US
<b>S.04.030</b>	Fault value 30	$-2^{31}$ to $2^{31}-1$	0	RW	Num				US
<b>S.04.031</b>	Fault value 31	$-2^{31}$ to $2^{31}-1$	0	RW	Num				US
<b>S.04.032</b>	Fault value 32	$-2^{31}$ to $2^{31}-1$	0	RW	Num				US

### 5.3.6 Menu 9 resources

Parameter		Range	Default						
<b>S.09.030</b>	PCB temperature 1	-128 °C to 127 °C		RO	Num	ND	NC	PT	
<b>S.09.031</b>	PCB temperature 2	-128 °C to 127 °C		RO	Num	ND	NC	PT	

# 6 Parameters

## 6.1 Menus

Table 6.1 below details each of the module's internal menus.

Menu	Description
S.0	Module information
S.1	PROFIBUS setup
S.2	Input mapping
S.3	Output mapping
S.4	Fault values
S.9	Resources

S is the slot number where the module is installed.

The module's menu 0 is also displayed in menu 15, 16 or 17 depending on which slot the module is installed to. Table 6.2 below shows the location of the module's menu 0 on the drive.

### NOTE

Menu 0 is not available in firmware version 01.01.01.02 and previous versions.

Table 6.2 SI-PROFIBUS menu 0 locations on the drive.

Slot number	Menu 0 locations
1	15
2	16
3	17

### Module menu 0 - Module Information

All parameters in Pr **S.00.ppp** (i.e. menu 0 within the Option module menus) are also present in menus 15, 16 or 17 depending on the slot that the module is installed to e.g. Pr **3.00.007** is also present as Pr **17.007**.

The functionality and properties of the parameters are identical between the two menus.

Module ID Code		
S.00.001	Default	443
	Range	0 to 999
	Access	RO

SI-PROFIBUS firmware version		
S.00.002	Default	N/A
	Range	00.00.00.00 to 99.99.99.99
	Access	RO

The firmware version of the Option module is in the format of **ww.xx.yy.zz**.

SI-PROFIBUS hardware version		
<b>S.00.003</b>	Default	N/A
	Range	00.00 to 99.99
	Access	RO

The hardware version of the Option module is in the format of **yy.zz**.

Serial Number LS		
<b>S.00.004</b>	Default	N/A
	Range	0 to 99999999
	Access	RO

Serial Number MS		
<b>S.00.005</b>	Default	N/A
	Range	0 to 99999999
	Access	RO

The module serial number is available as a pair of 32-bit values where Serial Number LS (Pr **S.00.004**) provides the least significant 8 decimal digits, and Serial Number MS (Pr **S.00.005**) provides the most significant 8 decimal digits. The reconstructed serial number is  $((S.00.005 \times 100000000) + S.00.004)$ . For example, serial number "0001234567898765" would be stored as Pr **S.00.005** = 12345 and Pr **S.00.004** = 67898765.

Module Status		
<b>S.00.006</b>	Default	N/A
	Range	0 to 99999999
	Access	RO

This parameter displays the current status of the module. All possible values are shown in the table below.

Value	Text	Description
0	Initializing	Module is currently initializing
1	OK	Module has initialized and has found no errors.
2	Config	A configuration error has been detected in one of the communications protocols or user program.
3	Error	An error has occurred preventing the firmware or user program running correctly.

Reset Module		
<b>S.00.007</b>	Default	Off (0)
	Range	Off (0) or On (1)
	Access	RW

Changes to the SI-PROFIBUS configuration will not take effect until the SI-PROFIBUS has been reset.



To reset the SI-PROFIBUS:

- Set Pr **S.00.007** to On (1).
- When the sequence has been completed, Pr **S.00.007** will be reset to Off (0).
- The SI-PROFIBUS will reset using the updated configuration.

**NOTE**

This sequence does NOT store the SI-PROFIBUS configuration parameters in the drive or the SI-PROFIBUS flash memory. This parameter will change back to Off (0) immediately and as such the change may not be visible on the display.

Default Module		
<b>S.00.008</b>	Default	Off (0)
	Range	Off (0) or On (1)
	Access	RW

If the host drive is defaulted (see the drive user guide for details), it will also clear the current configuration for the slot SI-PROFIBUS is installed to.

This can be performed as follows:

- Set Pr **S.00.008** to On (1).
- Reset the module by setting Pr **S.00.007** to On (1).
- SI-PROFIBUS communications will be stopped.
- Default parameter values for the SI-PROFIBUS will be loaded.
- The SI-PROFIBUS will reset using the default values.

Safety Information
Introduction
Mechanical Installation
Electrical Installation
Getting started
<b>Parameters</b>
GSD Files
Cyclic data
Non-cyclic data
Control and status words
Diagnostics
PROFIBUS profile (V4)
Advanced features
Legacy features
Glossary of terms
Index

## 6.2 Module menu 1 - PROFIBUS Setup

Menu 1 contains all the parameters relating to the setup of the PROFIBUS interface on the SI-PROFIBUS module.

Enable PROFIBUS Interface		
<b>S.01.001</b>	Default	On (1)
	Range	OFF (0) or On (1)
	Access	RO

This parameter displays a value of On (1) to indicate that the PROFIBUS Interface has been enabled.

Reset Profibus Interface		
<b>S.01.002</b>	Default	OFF (0)
	Range	OFF (0) or On (1)
	Access	RW

Changes to the SI-PROFIBUS configuration will not take effect until the SI-PROFIBUS has been reset.

To reset the SI-PROFIBUS:

- Set Pr **S.01.002** to On (1).
- When the sequence has been completed, Pr **S.01.002** will be reset to OFF (0).
- The SI-PROFIBUS will reset using the updated configuration.

### NOTE

This sequence does NOT store the SI-PROFIBUS configuration parameters in the drive or the SI-PROFIBUS flash memory. This parameter will change back to OFF immediately, and as such the change may not be visible in the display.

Default PROFIBUS Interface		
<b>S.01.003</b>	Default	OFF (0)
	Range	OFF (0) or On (1)
	Access	RW

If the host drive is defaulted (see the relevant *Drive User Guide* for details), it will also clear the current configuration for the slot SI-PROFIBUS is installed to.

This can be performed as follows:

- Set Pr **S.01.003** to On
- Reset the PROFIBUS interface by setting Pr **S.01.002** to On (1).
- SI-PROFIBUS communications will be stopped
- The host drive will load and store its default parameter values
- Default parameter values for the SI-PROFIBUS will be loaded
- The SI-PROFIBUS will reset using the default values

SI-PROFIBUS node address		
<b>S.01.004</b>	Default	126
	Range	0 to 126
	Access	RW

Every node on a PROFIBUS-DP network must be given a unique network node address. To activate a change in the node address value, the SI-PROFIBUS must be reset (Pr **S.01.002** or **MM.007** = On). Addresses 0 and 126 are reserved for system use.

Network baud rate		
<b>S.01.005</b>	Default	N/A
	Range	0 to 10
	Access	RO

The SI-PROFIBUS will automatically detect the PROFIBUS-DP network data rate and synchronize to it. Pr **S.01.005** will indicate the data rate that has been detected by the SI-PROFIBUS.

A value of 0 indicates that the SI-PROFIBUS has not detected any activity on the PROFIBUS-DP network, and is waiting for the master controller to start communicating.

**NOTE**

The PROFIBUS-DP data rate parameter can be changed, but this will not affect the data rate at which the SI-PROFIBUS communicates. The data rate display will be updated when the SI-PROFIBUS is reset.

**Table 6.3 SI-PROFIBUS data rates**

Pr <b>S.01.005</b>	Bits/s
<b>0</b>	<b>Auto-detecting</b>
<b>1</b>	<b>12 M</b>
<b>2</b>	<b>6.0 M</b>
<b>3</b>	<b>3.0 M</b>
<b>4</b>	<b>1.5 M</b>
<b>5</b>	<b>500 k</b>
<b>6</b>	<b>187.5 k</b>
<b>7</b>	<b>93.75 k</b>
<b>8</b>	<b>45.45 k</b>
<b>9</b>	<b>19.2 k</b>
<b>10</b>	<b>9.6 k</b>

SI-PROFIBUS network diagnostic		
<b>S.01.006</b>	Default	N/A
	Range	0 to 6
	Access	RO

SI-PROFIBUS cyclic data rate		
<b>S.01.007</b>	Default	N/A
	Range	0 to 9999 Messages/s
	Access	RO

The PROFIBUS-DP network activity can be monitored in the SI-PROFIBUS operating status parameter, Pr **S.01.006**. When the SI-PROFIBUS is in data exchange with the PROFIBUS-DP master controller, Pr **S.01.007** will give an indication of the number of cyclic data messages that are being processed per second. All possible values of **S.01.006** are given in Table 6.4.

Safety information
Introduction
Mechanical installation
Electrical installation
Getting started
<b>Parameters</b>
GSD files
Cyclic data
Non-cyclic data
Control and status words
Diagnostics
PROFIBUS profile (V4)
Advanced features
Legacy features
Glossary of terms
Index

**Table 6.4 All possible values for S.01.006**

Value	Text	Description
0	Network OK	Network OK/healthy.
1	Internal hardware failure	A part of the SI-PROFIBUS initialization sequence was not successful. If this fault persists after a power-cycle, replace the SI-PROFIBUS.
2	Initialized	The SI-PROFIBUS has initialized correctly and is waiting for the Profibus-DP master to initialise communications.
3	Network no data	Network OK/healthy but no network cycles per second detected.
4	First Failure	Mapping configuration fail when mappings are set by input mapping menu and output mapping menu ( <b>S.01.008</b> > 1) or ASCII configuration fail when mappings are set by GSD files ( <b>S.01.008</b> = 0).
5	Second Failure	Mapping configuration fail when mappings are set by input mapping menu and output mapping menu ( <b>S.01.008</b> > 1) or ASCII configuration fail when mappings are set by GSD files ( <b>S.01.008</b> = 0).
6	Third Failure	SI-PROFIBUS does not support CTNC or PPO4 ( <b>S.01.030</b> = 1 or 2), and does not support ProfiDrive V2 ( <b>S.01.008</b> > 2).

If a mapping configuration error (see section 10.6 Mapping status ) or network error (see section 10.8 Module error code) is detected.

Telegram selection		
<b>S.01.008</b>	Default	1
	Range	0 to 9
	Access	RW

If the telegram selection (Pr **S.01.008**) = Auto (0), the number of input and output cyclic words and the input and output mappings are set by the PLC master on the network. If this is the case, the number of input cyclic words (Pr **S.01.020**) and the number of output cyclic words (Pr **S.01.021**) are all read only.

If the telegram selection (Pr **S.01.008**) = Custom (1), the number of input and output cyclic words and the input and output mappings are set by the user. If this is the case, the number of input cyclic words (Pr **S.01.020**), the number of output cyclic words (Pr **S.01.021**) and the non-cyclic over cyclic parameter (Pr **S.01.030**) are all writeable.

If the telegram selection (Pr **S.01.008**) = STD Tel 1 (2), the number of input and output cyclic words and the input and output mappings are set by to PROFIdrive parameters. If this is the case, the number of input cyclic words (Pr **S.01.020**), the number of output cyclic words (Pr **S.01.021**) and the non-cyclic over cyclic parameter (Pr **S.01.030**) are all read only. The input mappings are PNU968 and PNU1001 and the output mappings are PNU967 and PNU1003.

Pr **S.02.001** will display 5.00.968 (PNU968), Pr **S.02.002** will display 5.01.001 (PNU1001), Pr **S.03.001** will display 5.00.967 (PNU967) and Pr **S.03.002** will display 5.01.003 (PNU1003).

Table 6.5 shows all the possible values of the Telegram selection (Pr **S.01.008**).

**Table 6.5 All values for Telegram selection**

Value	Text	Description
0	Auto	Mappings set by PLC
1	Custom	Mappings set by drive
2	STD Tel 1	Fixed mappings
3	STD Tel 1 + 6	SP compatibility mode only. 6 cyclic words (4 words user mappable)
4	STD Tel 1 +10	SP compatibility mode only. 10 cyclic words (8 words user mappable)
5	PPO1	SP compatibility mode only. 4 words non-cyclic, 2 words cyclic
6	PPO2	SP compatibility mode only. 4 words non-cyclic, 6 words cyclic
7	PPO3	SP compatibility mode only. 2 words cyclic
8	PPO4	SP compatibility mode only. 6 words cyclic
9	PPO5	SP compatibility mode only. 4 words non-cyclic, 10 words cyclic

As shown in Table 6.5, only Auto, Custom and STD Tel 1 are available when the SI-PROFIBUS module is connected to a Unidrive M and compatibility mode (Pr **S.01.031**) is set to Unidrive M. If any other telegram selection is made, the drive will display an alarm of Invalid IN map and Invalid OUT map (see Section 10 - Diagnostics for more information).

See section 14 *Legacy features* for more information on the full range of Telegram selection (Pr **S.01.008**) when in Unidrive SP compatibility mode.

Network loss selection		
<b>S.01.010</b>	Default	200 ms
	Range	0 to 3000 ms
	Access	RW

The network loss detection feature provides a method which ensures that communication with the master is still present. The SI-PROFIBUS resets an internal timer when a valid message is received from the SI-PROFIBUS network, if a message is not received within the specified period, network loss is detected.

**NOTE**

Network loss detection is not enabled internally until cyclic data has been detected. This prevents spurious network loss timeouts while the SI-PROFIBUS master controller is initializing the PROFIBUS-DP network.

Timeout action		
<b>S.01.011</b>	Default	Trip (0)
	Range	Trip (0) to No action (4)
	Access	RW

Safety information
Introduction
Mechanical installation
Electrical installation
Getting started
<b>Parameters</b>
GSD Files
Cyclic data
Non-cyclic data
Control and status words
Diagnostics
PROFIBUS profile (V4)
Advanced features
Legacy features
Glossary of terms
Index

Pr **S.01.011** determines the action to take when a timeout specified by Pr **S.01.010** occurs. All possible actions and descriptions are listed below.

Value	Text	Description
0	Trip	Trip the drive
1	Send fit values	Send fault values to output parameters
2	Clear output	PLC output parameters will have values set to zero
3	Hold last	Hold the last value in the PLC output parameters
4	No action	No action with output parameters

When a value of "Trip" is selected in Pr **S.01.011** and no cyclic communications have been detected in a time period defined by Pr **S.01.010** then the drive will trip displaying "SlotX Error" with a sub-trip string of "Link loss".

If the network loss timeout time (Pr **S.01.010**) is reduced too far, spurious network losses may occur due to a time-out occurring before the time period under normal operating conditions.



Network loss detection can be disabled by setting Pr **S.01.010** to 0. It is the user's responsibility to ensure that adequate safety precautions are taken to prevent damage or injury by disabling the drive in the event of a loss of communications.

If Pr **S.01.011** is set to "Send fit values", the fault values entered in Pr **S.04.001** to Pr **S.04.032** are sent to the mapped output parameters when a network timeout error occurs.

e.g. if Pr **S.03.001** = 20021 and Pr **S.03.002** = 20022 and a timeout error occurs, the value in Pr **S.04.001** will be sent to Pr **20.021** and the value in Pr **S.04.002** will be sent to Pr **20.022** as defined in the out mapping parameters.

If Pr **S.01.011** is set to "Clear output", all PLC output parameter values are set to zero.

e.g. if Pr **S.03.001** = 20021 and Pr **S.03.002** = 20022 and a timeout error occurs, Pr **20.021** and Pr **20.022** will be set to 0.

If Pr **S.01.011** is set to "Hold last", the last values sent by the PLC master are held in the mapped output parameters.

e.g. if Pr **S.03.001** = 20021 and Pr **S.03.002** = 20022 and a timeout error occurs, Pr **20.021** and Pr **20.022** will equal the last values sent by the PLC master.

If Pr **S.01.011** is set to "No action", then the module will not write any value to any mapped output parameters.

Timeout Event Destination		
<b>S.01.012</b>	Default	This Slot (0)
	Range	This Slot (0) to Event4 (4)
	Access	RW

Timeout Event Type		
<b>S.01.013</b>	Default	No Event (0)
	Range	No Event (0) to Event4 (4)
	Access	RW

When a timeout occurs, the SI-PROFIBUS module can trigger an event defined by Pr **S.01.013** to a destination, such as an Option Module installed to a different slot on the drive, defined by Pr **S.01.012**.

**NOTE**

If triggering an event to a different Option Module, Pr **S.01.012** must point to a slot where a compatible Option Module is installed to.

Cyclic data alignment		
<b>S.01.014</b>	Default	32 (0)
	Range	32 (0) or 16 (0) bits
	Access	RW

By default, the SI-PROFIBUS uses 32 bits for each data channel, even if the target parameter in the drive is a 16-bit parameter. This strategy (known as casting), ensures that the cyclic data transmitted over the SI-PROFIBUS network remains aligned with the memory locations in 32-bit PLC's. When cyclic data alignment (Pr **S.01.014**) is set to "16 bits", a data channel will only use 32 bits if the target drive parameter is a 32-bit parameter. If the target drive parameter is only 1, 8 or 16 bits wide, 16 bits will be used for that particular data channel as shown in the following table.

Parameter size (bits)	Actual data size (bits)	Actual data size (bits)
	Alignment = 16 bits	Alignment = 32 bits
1	16	32
8		
16		
32	32	

The following examples demonstrate setting up a network using five cyclic channels for both IN and OUT data with the cyclic data alignment first set to 32 bits and then set to 16 bits.

Table 6.6 shows the mapping parameters where five IN and five OUT cyclic data channels are required. With data alignment set to 32 bits, each data channel uses 32 bits (two data words, so a total of ten words are required).

Safety Information
Introduction
Mechanical Installation
Electrical Installation
Getting started
<b>Parameters</b>
GSD Files
Cyclic data
Non-cyclic data
Control and status words
Diagnostics
PROFIBUS profile (V4)
Advanced features
Legacy features
Glossary of terms
Index

**Table 6.6 Mapping parameters**

Data channel	Data words used	Mapping for slot 3	Setting	Data width (bits)	Mapping status
IN channel 1	IN word 0, 1	Pr <b>3.02.001</b>	0.10.040	16	Pr <b>10.040</b> , status word
IN channel 2	IN word 2, 3	Pr <b>3.02.002</b>	0.02.001	32	Pr <b>02.001</b> , post-ramp speed reference
IN channel 3	IN word 4, 5	Pr <b>3.02.003</b>	0.04.020	16	Pr <b>04.020</b> , Motor load as % of rated motor load
IN channel 4	IN word 6, 7	Pr <b>3.02.004</b>	0.14.021	16	Pr <b>14.021</b> , PID1 feedback
IN channel 5	IN word 8, 9	Pr <b>3.02.005</b>	0.14.001	16	Pr <b>14.001</b> , PID1 output
OUT channel 1	OUT word 0, 1	Pr <b>3.03.001</b>	0.06.042	16	Pr <b>06.042</b> , control word
OUT channel 2	OUT word 2, 3	Pr <b>3.03.002</b>	0.01.021	32	Pr <b>01.021</b> , preset reference 1
OUT channel 3	OUT word 4, 5	Pr <b>3.03.003</b>	0.02.011	32	Pr <b>02.011</b> , acceleration rate 1
OUT channel 4	OUT word 6, 7	Pr <b>3.03.004</b>	0.02.021	32	Pr <b>02.021</b> , deceleration rate 1
OUT channel 5	OUT word 8, 9	Pr <b>3.03.005</b>	0.14.020	16	Pr <b>14.020</b> , PID1 reference

It is advisable to keep 16-bit parameters paired together. This prevents mis-alignment of cyclic data with 32-bit PLC registers when using auto-mapping facilities to configure the SI-PROFIBUS network. By swapping the mappings for input channel 2 with input channel 3 and moving output channel 5 to output channel 2, the data channel structure will appear as shown in the table below.

Data channel	Data words used	Mapping for slot 3	Setting	Data width (bits)	Mapping status
IN channel 1	IN word 0	Pr <b>3.02.001</b>	0.10.040	16	Pr <b>10.040</b> , status word
IN channel 2	IN word 1	Pr <b>3.02.002</b>	0.04.020	16	Pr <b>04.020</b> , Motor load as % of rated motor load
IN channel 3	IN word 2, 3	Pr <b>3.02.003</b>	0.02.001	32	Pr <b>02.001</b> , post-ramp speed reference
IN channel 4	IN word 4	Pr <b>3.02.004</b>	0.14.021	16	Pr <b>14.021</b> , PID1 feedback
IN channel 5	IN word 5	Pr <b>3.02.005</b>	0.14.001	16	Pr <b>14.001</b> , PID1 output
OUT channel 1	OUT word 0	Pr <b>3.03.001</b>	0.06.042	16	Pr <b>06.042</b> , control word
OUT channel 2	OUT word 1	Pr <b>3.03.002</b>	0.14.020	16	Pr <b>14.020</b> , PID1 reference
OUT channel 3	OUT word 2, 3	Pr <b>3.03.003</b>	0.01.021	32	Pr <b>01.021</b> , preset reference 1
OUT channel 4	OUT word 4, 5	Pr <b>3.03.004</b>	0.02.011	32	Pr <b>02.011</b> , acceleration rate
OUT channel 5	OUT word 6, 7	Pr <b>3.03.005</b>	0.02.021	32	Pr <b>02.021</b> , deceleration rate 1

**Input cyclic words**

<b>S.01.020</b>	Default	4
	Range	1 to 32
	Access	RW

**Output cyclic words**

<b>S.01.021</b>	Default	4
	Range	1 to 32
	Access	RW



If the telegram selection (Pr **S.01.008**) = Auto (0), the number of input and output cyclic words and the input and output mappings are set by the PLC master on the network. If this is the case, the number of input cyclic words (Pr **S.01.020**) and the number of output cyclic words (Pr **S.01.021**) are all read only.

If the telegram selection (Pr **S.01.008**) = Custom (1), the number of input and output cyclic words and the input and output mappings are set by the user. If this is the case, the number of input cyclic words (Pr **S.01.020**), the number of output cyclic words (Pr **S.01.021**) and the non-cyclic over cyclic parameter (Pr **S.01.030**) are all writeable.

If the telegram selection (Pr **S.01.008**) = STD Tel 1 (2), the number of input and output cyclic words and the input and output mappings are set by to PROFIdrive parameters. If this is the case, the number of input cyclic words (Pr **S.01.020**), the number of output cyclic words (Pr **S.01.021**) and the non-cyclic over cyclic parameter (Pr **S.01.030**) are all read only. The input mappings are PNU968 and PNU1001 and the output mappings are PNU967 and PNU1003. Pr **S.02.001**, **S.02.002**, **S.03.001** and **S.03.002** will all display 1.

Input mapping status		
<b>S.01.022</b>	Default	0
	Range	0 to 12
	Access	RW

Output mapping status		
<b>S.01.023</b>	Default	0
	Range	0 to 12
	Access	RW

If the SI-PROFIBUS Network Diagnostic parameter (Pr **S.01.006**) indicates "First Failure" or "Second Failure", a mapping configuration error has been detected. The reason for the error is indicated by the SI-PROFIBUS input mapping status parameter (Pr **S.01.022**) and the SI-PROFIBUS output mapping status parameter (Pr **S.01.023**).

When a mapping error has been corrected, reset the SI-PROFIBUS module by setting Pr **S.01.002** or **MM.007** to On (1).

The input mapping error codes are described in Table 6.7 on page 34 and the output mapping error codes are described in Table 6.8 on page 34.

Safety Information
Introduction
Mechanical Installation
Electrical Installation
Getting started
<b>Parameters</b>
GSD Files
Cyclic data
Non-cyclic data
Control and status words
Diagnostics
PROFIdrive profile (V4)
Advanced features
Legacy features
Glossary of terms
Index

**Table 6.7 Input mapping error codes**

Value	Text	Description
0	No error	No error detected with IN cyclic data mapping configuration
1	Too many IN objs	Too many IN channels configured
2	No mapping	IN cyclic data length is 0 or there is no IN mapping.
3	Read mismatch	Parameter read error (parameter may not exist)
4	Hole in mappings	IN cyclic data mapping parameters are not contiguous
5	N-C mapping err	A non-cyclic data mode has been mapped more than once in the IN data mapping configuration parameters
6	Duplicate error	Two or more IN cyclic data mapping configuration parameters have been configured with the same destination parameter reference
7	Length mismatch	Mismatch in data length
8	IN MODE AND PPO	Non-cyclic and PPO STD Tel 1 both exist
9	Data align w PPO	Can't configure PPO when data alignment is set to 32 bits
10	No PPO support	PPO1-PPO5 not supported
11	SP A-D IN map	Input Mapping can't be set by GSD file automatically in SP mode
12	IN AND CTNC PPO4	CTNC and PPO4 not supported

**Table 6.8 Output mapping error codes**

Value	Text	Description
0	No error	No error detected with OUT cyclic data mapping configuration.
1	Mapping exceeded	Too many OUT channels configured
2	No mapping	OUT cyclic data length is 0 or there is no OUT mapping.
3	Write mismatch	Parameter write error (parameter may not exist or might be read-only)
4	Hole in mappings	OUT data mapping parameters are not contiguous
5	N-C mapping err	A non-cyclic data mode has been mapped more than once in the OUT data mapping configuration parameters
6	Duplicate error	Two or more OUT cyclic data mapping configuration parameters have been configured with the same destination parameter reference
7	Length mismatch	Mismatch in data length
8	OUT MODE AND PPO	Non-cyclic and PPO STD Tel 1 both exist
9	Data align w PPO	Can't configure PPO when data alignment is set to 32 bits
10	No PPO support	PPO1-PPO5 not supported
11	SP A-D OUT map	Output Mapping can't be set by GSD file automatically in SP mode
12	OUT AND CTNC PPO4	CTNC and PPO4 not supported

Input processing time		
S.01.024	Default	N/A
	Range	0 to 65535
	Access	RO

Output processing time		
<b>S.01.025</b>	Default	N/A
	Range	0 to 65535
	Access	RW

Pr **S.01.024** and Pr **S.01.025** display the input and output processing times respectively. The input processing time (Pr **S.01.024**) shows the time taken from the value being sent from the drive to the value being written to the master in milliseconds. The output processing time (Pr **S.01.025**) shows the time taken from the value being sent from the master to the value being successfully written to the drive in milliseconds.

Input consistency action		
<b>S.01.026</b>	Default	OFF (0)
	Range	OFF (0) or On (1)
	Access	RW

Input Consistency Trigger Parameter		
<b>S.01.027</b>	Default	N/A
	Range	0.00.000 to 4.99.999
	Access	RW

Output consistency action		
<b>S.01.028</b>	Default	OFF (0)
	Range	OFF (0) or On (1)
	Access	RW

Output Consistency Trigger Parameter		
<b>S.01.029</b>	Default	N/A
	Range	0.00.000 to 4.99.999
	Access	RW

The SI-PROFIBUS module provides an input/output consistency feature which ensures that the data in the input or output mappings is only transferred between the SI-PROFIBUS module and the master when the mapped parameters are ready. This prevents data skew between parameters in the input/output mappings.

If Input consistency action (Pr **S.01.026**) and Output consistency action (Pr **S.01.028**) are set to 0 (i.e. default settings), then the input/output consistency features are disabled so that input and output data is always read from or written to the master/module.

Safety information
Introduction
Mechanical installation
Electrical installation
Getting started
<b>Parameters</b>
GSD Files
Cyclic data
Non-cyclic data
Control and status words
Diagnostics
PROFIBUS profile (V4)
Advanced features
Legacy features
Glossary of terms
Index

If Input Consistency Action (Pr **S.01.026**) is set to On (1), the SI-PROFIBUS module will check the value of the parameter specified by the Input Consistency Trigger Source Parameter (Pr **S.01.027**). If the input trigger source parameter defined by Pr **S.01.027** is set to a non-zero value (for example by a user program in an applications module), this indicates to the SI-PROFIBUS module that all the mapped parameters are ready to be read. The module will then read the mapped parameters, transfer them to the master and will then clear the input trigger source parameter to zero. When the input trigger source parameter is set to zero, the SI-PROFIBUS module will continue to transfer the previously read data to the master.

If Output Consistency Action (Pr **S.01.028**) is set to On (1), the SI-PROFIBUS module will check the value of the parameter specified by the Output Consistency Trigger Source Parameter (Pr **S.01.029**). The output trigger source parameter defined by Pr **S.01.029** will initially be set to 1.

If the output trigger source parameter is set to zero (for example by a user program in an applications module), this indicates to the SI-PROFIBUS module that all the mapped parameters are ready to be written to. The module will then write the data from the master into the mapped parameters, and will then set the output trigger source parameter to 1. When the output trigger source parameter is set to 1, it indicates to the SI-PROFIBUS module that the mapped parameters are not ready to be written to, and therefore any new data from the master will not be written to the mapped parameters in the drive until the output trigger source parameter is again set to zero.

Non-Cyclic over Cyclic		
<b>S.01.030</b>	Default	None (0)
	Range	None (0) to PPO defined (2)
	Access	RW

Sending non-cyclic data over the cyclic channel can only be accomplished when the SI-PROFIBUS module is set up for a Unidrive SP in compatibility mode (Pr **S.01.031** = 2 or 3) and the correct GSD file loaded. The correct GSD file for the simulated drive (e.g. SP\_0672.GSD)

The term 'non-cyclic over cyclic' is used to refer to non-cyclic data which is transmitted as part of the cyclic data and not using the non-cyclic DP-V1 channel.

The table below shows how to configure the non-cyclic over cyclic parameter (Pr **S.01.030**) for the required non-cyclic mode.

Value	Text	Description
<b>0</b>		
<b>1</b>	CTNC	1 Non-cyclic word (CT Single Word mode 1)
<b>2</b>	PPO defined	4 Non-cyclic words (PPO 4 Word mode 2)

For more information on sending / receiving non-cyclic data see section 9 *Non-cyclic data* on page 48.

Network compatibility mode		
<b>S.01.031</b>	Default	Auto detect (0)
	Range	None (0) to PPO defined (2)
	Access	RW


A backwards compatibility mode is present in SI-PROFIBUS. Pr **S.01.031** can be used to allow the SI-PROFIBUS module to appear as a Unidrive SP, this only applies to the network and not the control/status words and parameter sizes. The module must be configured to match the existing network settings of the drive it is replacing (including any parameter mappings).

Value	Text	Description
0	Auto detect	Auto detect
1	Unidrive M	Unidrive M mode
2	UniSP	Unidrive SP mode
3	UniSP extended	Unidrive SP mode with Extended Diagnostics Support

Using the compatibility mode allows the replacement of drives on a PROFIBUS-DP network, without having to make any changes to the master network configuration, it changes the identity code of the module so that the master believes that a similar type drive is present for a particular node.

**NOTE**

When using compatibility mode, ensure that the correct GSD file for the simulated drive is being used and not the actual drive.

	<p>This mode only changes the network to emulate the Unidrive SP on the network. Changes to the control method and data size differences must still be considered. This mode does NOT allow direct replacement.</p>
---	---

When using extended diagnostics (Pr **S.01.031** = 3), the appropriate GSD file using the correct PROFIBUS identification code (0x0B4F) must be used (e.g. 'SP\_\_0B4F.GSD'. For GSD file compatibility, please refer to Table 7.1 *Selecting the correct GSD file* on page 43.

Safety information
Introduction
Mechanical installation
Electrical installation
Getting started
<b>Parameters</b>
Files
GSD
Cyclic data
Non-cyclic data
Control and status words
Diagnostics
PROFIBUS profile (V4)
Advanced features
Legacy features
Glossary of terms
Index

## 6.3 Module menu 2 - Input Mapping

Menu 2 contains all the mapping parameters relating to the IN channels of the module.

The values set in each parameter are in the format of **S.mm.ppp** where:

**S** = slot number of the target/source parameter

**mm** = menu number of the target /source parameter

**ppp** = parameter number of the target/source parameter

IN channel	Mapping parameter	Default value
1	Pr S.02.001	0.10.040
2	Pr S.02.002	0.02.001
3	Pr S.02.003	0.00.000
4	Pr S.02.004	0.00.000
5	Pr S.02.005	0.00.000
6	Pr S.02.006	0.00.000
7	Pr S.02.007	0.00.000
8	Pr S.02.008	0.00.000
9	Pr S.02.009	0.00.000
10	Pr S.02.010	0.00.000
11	Pr S.02.011	0.00.000
12	Pr S.02.012	0.00.000
13	Pr S.02.013	0.00.000
14	Pr S.02.014	0.00.000
15	Pr S.02.015	0.00.000
16	Pr S.02.016	0.00.000
17	Pr S.02.017	0.00.000
18	Pr S.02.018	0.00.000
19	Pr S.02.019	0.00.000
20	Pr S.02.020	0.00.000
21	Pr S.02.021	0.00.000
22	Pr S.02.022	0.00.000
23	Pr S.02.023	0.00.000
24	Pr S.02.024	0.00.000
25	Pr S.02.025	0.00.000
26	Pr S.02.026	0.00.000
27	Pr S.02.027	0.00.000
28	Pr S.02.028	0.00.000
29	Pr S.02.029	0.00.000
30	Pr S.02.030	0.00.000
31	Pr S.02.031	0.00.000
32	Pr S.02.032	0.00.000

## 6.4 Module menu 3 - Output Mapping

Menu 3 contains all the mapping parameters relating to the OUT channels of the module.

The values set in each parameter are in the format of **S.mm.ppp** where:

**S** = slot number of the target/source parameter

**mm** = menu number of the target /source parameter

**ppp** = parameter number of the target/source parameter

OUT channel	Mapping parameter	Default value
1	Pr S.03.001	0.06.042
2	Pr S.03.002	0.01.021
3	Pr S.03.003	0.00.000
4	Pr S.03.004	0.00.000
5	Pr S.03.005	0.00.000
6	Pr S.03.006	0.00.000
7	Pr S.03.007	0.00.000
8	Pr S.03.008	0.00.000
9	Pr S.03.009	0.00.000
10	Pr S.03.010	0.00.000
11	Pr S.03.011	0.00.000
12	Pr S.03.012	0.00.000
13	Pr S.03.013	0.00.000
14	Pr S.03.014	0.00.000
15	Pr S.03.015	0.00.000
16	Pr S.03.016	0.00.000
17	Pr S.03.017	0.00.000
18	Pr S.03.018	0.00.000
19	Pr S.03.019	0.00.000
20	Pr S.03.020	0.00.000
21	Pr S.03.021	0.00.000
22	Pr S.03.022	0.00.000
23	Pr S.03.023	0.00.000
24	Pr S.03.024	0.00.000
25	Pr S.03.025	0.00.000
26	Pr S.03.026	0.00.000
27	Pr S.03.027	0.00.000
28	Pr S.03.028	0.00.000
29	Pr S.03.029	0.00.000
30	Pr S.03.030	0.00.000
31	Pr S.03.031	0.00.000
32	Pr S.03.032	0.00.000

## 6.5 Module menu 4 - Fault Values

Menu 4 contains all the fault values that are sent to the mapped output destination parameters when fault values have been configured to be sent using an action parameter.

<b>OUT channel</b>	<b>Parameter</b>
1	Pr S.04.001
2	Pr S.04.002
3	Pr S.04.003
4	Pr S.04.004
5	Pr S.04.005
6	Pr S.04.006
7	Pr S.04.007
8	Pr S.04.008
9	Pr S.04.009
10	Pr S.04.010
11	Pr S.04.011
12	Pr S.04.012
13	Pr S.04.013
14	Pr S.04.014
15	Pr S.04.015
16	Pr S.04.016
17	Pr S.04.017
18	Pr S.04.018
19	Pr S.04.019
20	Pr S.04.020
21	Pr S.04.021
22	Pr S.04.022
23	Pr S.04.023
24	Pr S.04.024
25	Pr S.04.025
26	Pr S.04.026
27	Pr S.04.027
28	Pr S.04.028
29	Pr S.04.029
30	Pr S.04.030
31	Pr S.04.031
32	Pr S.04.032



## 6.6 Module menu 9 - Resources

PCB Temperature 1		
S.09.030	Default	N/A
	Range	-128°C to 127°C
	Access	RO

PCB Temperature 2		
S.09.031	Default	N/A
	Range	-128°C to 127°C
	Access	RO

Parameters Pr **S.09.030** and Pr **S.09.031** display the current temperature of the 2 internal thermistors within the option module.

Safety information
Introduction
Mechanical installation
Electrical installation
Getting started
<b>Parameters</b>
GSD Files
Cyclic data
Non-cyclic data
Control and status words
Diagnostics
PROFIBUS profile (V4)
Advanced features
Legacy features
Glossary of terms
Index

---

# 7 GSD Files

---

## 7.1 What are GSD Files?

GSD files are text files that are used by the PROFIBUS-DP network configuration software tools. They contain information about the device timings, supported features and available data formats for the SI-PROFIBUS device. Drive icon files are also supplied for use with the SI-PROFIBUS configuration software. GSD files are available from your supplier, local Control Techniques Drive Centre or the Control Techniques website ([www.controltechniques.com](http://www.controltechniques.com)).

## 7.2 Data consistency

There is a potential problem with data skew when transferring blocks of data to and from a PROFIBUS-DP master controller. Data skew happens when a value is spread across multiple words; when this occurs it is possible that only half of the correct value reaches the destination. Consider the following example:

- The PLC has a value of 0xFFFFFFFF to send to the drive.
- The drive currently has a value of 0x00000000 in a 32-bit parameter.
- The master sends the word without consistency.
- The drive receives one 16-bit word and now has the value 0x0000FFFF.
- The drive receives the next 16-bit word and now has the value 0xFFFFFFFF.

To prevent data skew PROFIBUS-DP has a feature known as 'data consistency'. Consistent data defines a block of data words that must ALL be updated before ANY of the new data values are transmitted. Consequently, the message sent over the PROFIBUS-DP network will have a true representation of the required data. Some PLCs have special functions available to transfer blocks of consistent data to a PROFIBUS-DP master controller and guarantee that data skew cannot occur.

## 7.3 Data configuration

The GSD file describes the modules of input or output words that may be combined to configure the input and output configuration for a specific node. The complete input and output configuration for the node is built by adding the required modules until all of the node's inputs and outputs are defined.

**NOTE** A module consists of a block of input or output data. Put simply this is a logical collection of data words.

The number of input or output words configured in the drive must match the number of input or output words defined in the master; if the master has eight IN and four OUT words the drive must use the same settings to communicate correctly.

The SI-PROFIBUS module uses Pr **S.01.020** and Pr **S.01.021** to independently set the number of input and output words respectively.

**NOTE** The definition of a data word is 16 bits. By default SI-PROFIBUS casts all data as long words/double words (32 bits), data alignment can be used to reduce this size, see for more information.

## 7.4 GSD compatibility

For PROFIBUS DP-V1 features to be available to the PLC, the appropriate DP-V1 GSD file must be installed and the drive configured in the master PLC as a 'DPV1' slave.

## 7.5 GSD compatibility table

Table 7.1 can be used to determine which GSD file should be used.

**Table 7.1 Selecting the correct GSD file**

Simulated drive	Compatibility mode (Pr S.01.031)	GSD file
Unidrive M	Unidrive M	UniM__0DB8.GSD
Unidrive SP	UniSP	SP__0672.GSD
Unidrive SP with extended diagnostics	UniSP extended	SP__0B4F.GSD

Safety information
Introduction
Mechanical installation
Electrical installation
Getting started
Parameters
<b>GSD Files</b>
Cyclic data
Non-cyclic data
Control and status words
Diagnostics
PROdrive profile (V4)
Advanced features
Legacy features
Glossary of terms
Index

---

## 8 Cyclic data

---

### 8.1 What is cyclic data?

Cyclic data transfer is a method of transferring data on a regular time period, often known as 'polled data'. High-speed data transfer is achieved by transmitting only data bytes over the PROFIBUS-DP network and using local mapping information within the SI-PROFIBUS and PROFIBUS-DP master controller to ensure that the correct data is sent to the correct locations. The flexibility of the SI-PROFIBUS means that each cyclic data OUT channel can be directed to any read/write drive parameter. Similarly each cyclic data IN channel can use any drive parameter as a source of data.

**NOTE**

- The term OUT data refers to data that is transmitted out of the master to the slave.
- The term IN data refers to data that is returned from a slave into the master.
- Cyclic data mapping cannot be changed dynamically, as changes to the configuration (mapping parameters, etc.) will only take effect during initialization of the SI-PROFIBUS.
- The maximum number of 16-bit mappings that is possible is 32 with only cyclic data, this requires data alignment to be set to 16, see for more information.
- The maximum number of 32-bit mappings that is possible is 16 with only cyclic data.

See section 8.7 *Master configuration* on page 47 for more information regarding the use of data alignment with 16-bit parameters.

### 8.2 Data formats

The SI-PROFIBUS can be configured with up to sixteen 32-bit or thirty-two 16-bit cyclic IN and OUT data words. IN and OUT cyclic data words are mapped using up to 32 mapping (pointer) parameters, one for each mapping.

**NOTE**

By default all drive parameters are cast as 32-bit (two 16-bit words) therefore thirty-two cyclic words gives sixteen possible drive parameters. Data alignment reduces the number of cyclic words required for drive parameters of 16-bit (or less) to 16 bits thus allowing for thirty-two possible 16-bit parameters. Any 32-bit parameters mapped will still require two 16-bit words even with alignment set to 16.

In addition to cyclic data, non-cyclic data (see ) exchange is also possible by the following methods:

- DP-V1 parameter access mode.

The method used to map cyclic data to and from the PROFIBUS-DP network is similar to the method used in the drive for mapping analog and digital I/O. The reference for the source or target parameter is entered in the mapping parameter in the form **mm.ppp**, where:

**mm** = menu number of the target/source parameter

**ppp** = parameter number of the target/source parameter.

**Table 8.1 SI-PROFIBUS mapping parameters**

IN channel	Mapping parameter	OUT channel	Mapping parameter
1	Pr <b>S.02.001</b>	1	Pr <b>S.03.001</b>
2	Pr <b>S.02.002</b>	2	Pr <b>S.03.002</b>
3	Pr <b>S.02.003</b>	3	Pr <b>S.03.003</b>
4	Pr <b>S.02.004</b>	4	Pr <b>S.03.004</b>
5	Pr <b>S.02.005</b>	5	Pr <b>S.03.005</b>
6	Pr <b>S.02.006</b>	6	Pr <b>S.03.006</b>
7	Pr <b>S.02.007</b>	7	Pr <b>S.03.007</b>
8	Pr <b>S.02.008</b>	8	Pr <b>S.03.008</b>
9	Pr <b>S.02.009</b>	9	Pr <b>S.03.009</b>
10	Pr <b>S.02.010</b>	10	Pr <b>S.03.010</b>
11	Pr <b>S.02.011</b>	11	Pr <b>S.03.011</b>
12	Pr <b>S.02.012</b>	12	Pr <b>S.03.012</b>
13	Pr <b>S.02.013</b>	13	Pr <b>S.03.013</b>
14	Pr <b>S.02.014</b>	14	Pr <b>S.03.014</b>
15	Pr <b>S.02.015</b>	15	Pr <b>S.03.015</b>
16	Pr <b>S.02.016</b>	16	Pr <b>S.03.016</b>
17	Pr <b>S.02.017</b>	17	Pr <b>S.03.017</b>
18	Pr <b>S.02.018</b>	18	Pr <b>S.03.018</b>
19	Pr <b>S.02.019</b>	19	Pr <b>S.03.019</b>
20	Pr <b>S.02.020</b>	20	Pr <b>S.03.020</b>
21	Pr <b>S.02.021</b>	21	Pr <b>S.03.021</b>
22	Pr <b>S.02.022</b>	22	Pr <b>S.03.022</b>
23	Pr <b>S.02.023</b>	23	Pr <b>S.03.023</b>
24	Pr <b>S.02.024</b>	24	Pr <b>S.03.024</b>
25	Pr <b>S.02.025</b>	25	Pr <b>S.03.025</b>
26	Pr <b>S.02.026</b>	26	Pr <b>S.03.026</b>
27	Pr <b>S.02.027</b>	27	Pr <b>S.03.027</b>
28	Pr <b>S.02.028</b>	28	Pr <b>S.03.028</b>
29	Pr <b>S.02.029</b>	29	Pr <b>S.03.029</b>
30	Pr <b>S.02.030</b>	30	Pr <b>S.03.030</b>
31	Pr <b>S.02.031</b>	31	Pr <b>S.03.031</b>
32	Pr <b>S.02.032</b>	32	Pr <b>S.03.032</b>

**NOTE** A cyclic data channel does not use decimal points. For example, in Open Loop mode, digital speed reference 1 (Pr **01.021**) has units of Hertz, accurate to 1 decimal place. To write a value of 24.6 Hz to Pr **01.021**, the value must be transmitted as 246.

If a mapping parameter is set to an invalid value (e.g. the destination parameter is read only, or the parameter does not exist), the SI-PROFIBUS will indicate a failure error in the PROFIBUS Network Diagnostic parameter (Pr **S.01.006**). The reason for the failure error will be indicated by the mapping status parameter (Pr **S.01.022**) and (**S.01.023**). Refer to for more details.

Safety information
Introduction
Mechanical installation
Electrical installation
Getting started
Parameters
GSD Files
Cyclic data
Non-cyclic data
Control and status words
Diagnostics
PROFIBUS profile (V4)
Advanced features
Legacy features
Glossary of terms
Index

## 8.3 Mapping conflicts

Care must be taken to ensure that there are no clashes between mappings in the SI-PROFIBUS cyclic OUT data and other drive parameters such as:

- Other SI-PROFIBUS cyclic OUT channels
- Mappings from additional option modules if installed
- Analog inputs
- Digital inputs
- Logic outputs
- Motorized pot output
- Comparator outputs
- Variable selected outputs

The SI-PROFIBUS will not indicate if there is a mapping conflict due to any one of the reasons listed. Should a conflict occur and a parameter is written to from two or more different sources, the value of this parameter will depend entirely upon the scan times for the function and the PROFIBUS-DP network. The result would be that a parameter may appear to be steady at a particular value on the drive display, although an occasional glitch in the displayed value may be seen. Internally however, this value may be changing continuously between two values, leading to unusual behavior in the drive.

## 8.4 Cyclic data mapping errors

The SI-PROFIBUS module will scan and check the PROFIBUS-DP mapping parameter configuration for errors during initialization. If an error is detected, then the SI-PROFIBUS operating status parameter (Pr **S.01.006**) will indicate “Initialized”, and the configuration error detected will be indicated in mapping status parameter, Pr **S.01.022** and **S.01.023**. See for full details.

## 8.5 Mapping limitations

When setting mapping values care should be taken not to exceed the data size set in Pr **S.01.020** and Pr **S.01.021**. The data size depends on the size of the mapped parameter and if data alignment is set to 16 or 32 (see Table 8.2).

**Table 8.2 Actual data sizes**

Parameter size (bits)	Actual data size (bits) alignment=16	Actual data size (bits) alignment=32
1	16	32
8		
16		
32	32	

Consider the following example:

- mapping Pr **S.02.001** to a 32-bit value and **S.02.002** to a 16-bit value
- mapping Pr **S.03.001** to a 32-bit value and **S.03.002** to a 32-bit value
- data alignment set to 16 bits (Pr **S.01.014** set to 16)

would require the following settings to be made:

- Pr **S.01.020** = 3
- Pr **S.01.021** = 4

## 8.6 Disabling mappings

Any unused mapping parameters (Pr **S.02.001** to Pr **S.02.032** and Pr **S.03.001** to Pr **S.03.032**) should be set to 0.

**NOTE** Having unmapped channels between valid mapped channels is not permitted and will result in a configuration error (i.e. Pr **S.01.006** will indicate “First Failure” or “Second Failure”).

## 8.7 Master configuration

The SI-PROFIBUS can be configured by the master controller. If Pr **S.01.008** is set to Auto, data alignment (Pr **S.01.014**) and input/output mapping (Pr **S.02.ppp**, Pr **S.03.ppp**) can be set by the master controller. The number of input/output words (Pr **S.01.020**) will be obtained automatically. If there is no master connected to the module, Pr **S.01.006** will set to 1.

Safety information
Introduction
Mechanical installation
Electrical installation
Getting started
Parameters
GSD Files
Cyclic data
Non-cyclic data
Control and status words
Diagnostics
PROFIBUS profile (V4)
Advanced features
Legacy features
Glossary of terms
Index

---

## 9 Non-cyclic data

---

### 9.1 What is non-cyclic data?

Non-cyclic data allows access to any parameter without the need to use cyclic data transfers. This is particularly useful when accessing many different parameters for set-up or archiving of drive settings. The method to use non-cyclic data on the SI-PROFIBUS is by using DP-V1 Parameter Access.

#### 9.1.1 DP-V1 Parameter Access

Non-cyclic data is transmitted after all the cyclic data within the PROFIBUS-DP cycle, depending on the length of the non-cyclic data, this may take several cycles to complete.

### 9.2 Configuration using non-cyclic data

The SI-PROFIBUS can be configured using the DP-V1 Parameter Access channel non-cyclic data. This is useful when using a master controller to configure the drive; when a drive is initialized only the node address **S.01.004** needs to be set manually. The master can now use the desired mode to setup the remainder of the parameters.

The configuration parameters for the slot in which the SI-PROFIBUS is located can be accessed in **S.01.ppp** and **MM.ppp**. Any changes made to the configuration parameters will not take effect until the SI-PROFIBUS has been reset. SI-PROFIBUS can be reset by writing a value of 1 to Pr MM.007. A brief interruption in PROFIBUS-DP communications may be seen while the reset sequence is in progress.

### 9.3 SI-PROFIBUS overview

The SI-PROFIBUS specification allows for the standard cyclic process data and the additional acyclic parameter data to be transmitted in the same bus cycle.

The DP-V1 message is contained within the acyclic part of the PROFIBUS-DP cycle and uses the slave node address to access the parameter channel.

For further details of the SI-PROFIBUS functionality refer to the official PROFIBUS website at [www.profibus.com](http://www.profibus.com)

The following services will be supported:

- Class 1 Master Read and Write
- Class 2 Master Read and Write
- Class 2 Master Initiate Connection
- Class 2 Master Abort Connection

A class 1 master must be in data exchange with the slave before it can perform a request via the DP-V1 channel. A class 2 master must initiate the connection with the slave before sending the DP-V1 message, likewise it must then abort the connection when it is no longer required.

**NOTE** SI-PROFIBUS supports the simultaneous connection to one class 1 master and one class 2 master.



SI-PROFIBUS supports the following features:

- DP-V1 Parameter Access
- PROFIdrive PNU Access (see )
- Fault Buffer (see )
- Drive Identification (see )
- Identification and Maintenance Functions (see )

The maximum DP-V1 message length is restricted to 128 bytes including the four bytes of the DP-V1 header and the four bytes of the PROFIdrive request, this leaves a maximum of 120 bytes for the parameter data; the maximum number of parameters that can be read or written in a single message is shown in Table 9.1.

**Table 9.1 Single message parameter limitation**

Mode	Maximum number of parameters	
	16-bit	32-bit
Read	20	20
Write	12	10

### 9.3.1 DP-V1 Parameter Access

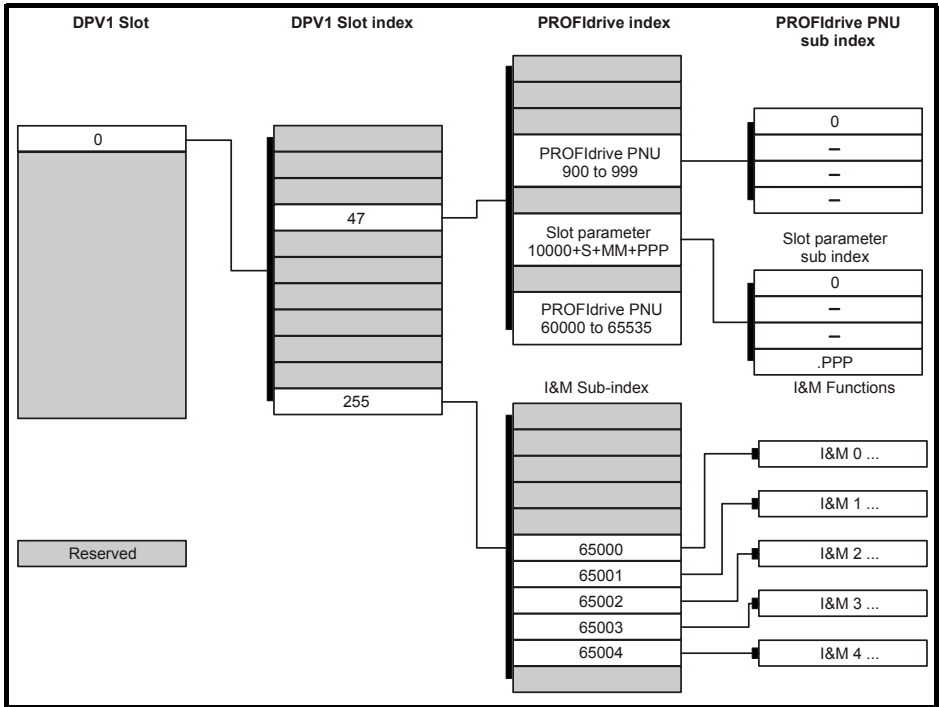
Drive parameters (and PROFIdrive PNU's) can be accessed using the PROFIdrive Parameter Channel, the global slot number 0 and slot sub-index 47. This is illustrated in Figure 9-1.

**NOTE** DP-V1 slot numbers 1 and 2 are also allowed when the DP-V1 slot index = 47 (for the I&M function, DP-V1 slot must be zero.

**NOTE** The PROFIdrive PNU's will be accessible using functions available in the master.

Safety information
Introduction
Mechanical installation
Electrical installation
Getting started
Parameters
GSD Files
Cyclic data
Non-cyclic data
Control and status words
Diagnostics
PROFIdrive profile (V4)
Advanced features
Legacy features
Glossary of terms
Index

**Figure 9-1 DP-V1 Parameter Channel**



The parameter channel requires a parameter index and subindex to access parameters.

Drive parameters can be accessed by placing the result of the equations:

If the parameter is 99 or less:

$$10000 + (S \times 10000) + (MM \times 100) + ppp$$

in the parameter Index field of the PROFdrive request, the sub-index field is always set to 0.

For example, Pr **01.021** (Preset Reference 1) would be entered as:

$$10000 + (0 \times 10000) + (1 \times 100) + 21 = 10121$$

If the parameter is greater than 99:

$$10000 + (S \times 10000) + (MM \times 100) + 99, \text{ sub-index is set to } (ppp-99).$$

For example, Pr **03.127** (P2 Speed Feedback) would be entered as:

$$10000 + (0 \times 1000) + (3 \times 100) + 99 = 10399 \text{ with a sub-index of } (127-99) = 28$$

PROFdrive Parameters (PNU's) can be accessed by placing the PNU number in the parameter index field and if the PNU data type is an array, then the sub-index field may also be specified.

# 10 Control and status words

## 10.1 What are control and status words?

The control and status words allow the digital control and monitoring of the drive to be implemented using a single data word for each function. Each bit in the control word has a particular function and provides a method of controlling the output functions of the drive, such as run and direction.

Each bit in the status word provides feedback about the drive's state of health and operational condition, such as drive ok, drive at speed, etc.

## 10.2 Control word

The SI-PROFIBUS control word consists of sixteen control bits some of which are reserved. See Table 10.1 for the individual bit function descriptions.

**Table 10.1 Control word bit definitions**

b15	b14	b13	b12	b11	b10	b9	b8
	KEYPAD WDOG	RESET	TRIP			JOG REV	REMOTE
b7	b6	b5	b4	b3	b2	b1	b0
AUTO	NOT STOP	RUN	FWD REV	RUN REV	JOG FWD	RUN FWD	ENABLE

To enable fieldbus control, the fieldbus enable signal (Pr **06.043**) and the auto bit (b7) must both be set to '1'. When the AUTO bit is reset to 0 the drive will revert to terminal control.

For safety reasons, the external HARDWARE ENABLE signal must be present before the fieldbus control word can be used to start the drive. This terminal is normally controlled by an external "Emergency Stop" circuit to ensure that the drive is disabled in an emergency situation.

The control word REMOTE bit directly controls the drive parameter Pr **01.042**, the function of which is to select the digital speed reference as the source of the drive's speed reference. When the REMOTE bit is reset to 0 the drive will revert to using the external analog speed reference.

The actual digital speed reference selected when REMOTE is set to 1 will be Pr **01.021**, which is also the default mapping for the fieldbus speed reference. However Pr **01.015** can be used to change which of the digital references is selected. For further details on the drive digital speed reference, please refer to the appropriate drive user guide.

Table 10.2 lists in detail the function of each control word bit. For further in-depth details about drive control words and sequencing bits please refer to the appropriate drive documentation.

**NOTE** When a trip occurs, the drive control word MUST be set to a safe, disabled state. This ensures that the drive does not re-start unexpectedly when it is reset. This can be achieved by continuously monitoring the drive status word, and interlocking it with the control word.

**NOTE** By default data alignment is set to 32 and therefore the control word will be cast as 32-bit with bits 16 to 31 reserved.

Safety information
Introduction
Mechanical installation
Electrical installation
Getting started
Parameters
GSD Files
Cyclic data
Non-cyclic data
<b>Control and status words</b>
Diagnostics
PRODrive profile (V4)
Advanced features
Legacy features
Glossary of terms
Index

**Table 10.2 Control word bit functions**

Bit	Function	Description
0	ENABLE	Set to 1 to enable the drive. Resetting to 0 will immediately disable the drive, and the motor will coast to a stop. The external HARDWARE ENABLE signal must also be present before the drive can be enabled.
1	RUN FWD	Set to 1 (with ENABLE set to 1) to run the motor in the forward direction. When reset to 0, the drive will decelerate the motor to a controlled stop.
2	JOG FWD	Set to 1 to jog the motor forward. This signal needs to be used in conjunction with the ENABLE bit. This signal is overridden by a RUN, RUN REV or RUN FWD signal.
3	RUN REV	Set to 1 (with ENABLE set to 1) to run the motor in the reverse direction. When reset to 0, the drive will decelerate the motor to a controlled stop.
4	FWD REV	Set to 1 to select the reverse direction. Set to 0 to run in the forward direction. The RUN signal is used to start and stop the motor.
5	RUN	Set to 1 to run the motor. FWD REV is used to select the direction of motor rotation. When reset to 0, the drive will decelerate the motor to a controlled stop.
6	NOT STOP	Set to 1 to allow the sequencing bit to be latched. If NOT STOP is zero, all latches are cleared and held at 0. Pr <b>06.004</b> must be correctly set for this to function.
7	AUTO	Set to 1 to enable fieldbus control of the drive Control Word. The Control Word Enable (Pr <b>06.043</b> ) must also be set to 1. When reset to 0, the drive will operate under terminal control.
8	REMOTE	Set to 1 to select digital speed reference 1 (Pr <b>01.021</b> ), and reset to 0 to select analog reference 1 (Pr <b>01.036</b> ). REMOTE directly controls Pr <b>01.042</b> , so reference selector (Pr <b>01.014</b> ) and preset selector (Pr <b>01.015</b> ) must both be set to 0 (default) for the REMOTE bit to work properly.
9	JOG REV	Set to 1 to jog the motor in reverse. This signal needs to be used in conjunction with the ENABLE bit. This signal is overridden by a RUN/RUN REV/RUN FWD command.
10	Reserved	
11	Reserved	
12	TRIP	Set to 1 to trip the drive at any time. The trip display on drive will be CL.bit and the trip code will be 35. AUTO (b7) has no effect on this function. The trip cannot be cleared until TRIP is reset to 0.

Bit	Function	Description
13	RESET	A 0-1 transition of the RESET bit will reset the drive from a trip condition. If the reason for the trip is still present, or another fault condition has been detected, the drive will immediately trip again. When resetting the drive, it is recommended to check the status word to ensure that the reset was successful, before attempting to re-start the drive.
14	KEYPAD WDOG	This watchdog is provided for an external keypad or other devices where a break in the communication link must be detected. The watchdog system can be enabled and/or serviced if this bit is changed from zero to one while the control word enabled. Once the watchdog is enabled it must be serviced at least once every second or an SCL trip will occur. The watchdog is disabled when an SLC trip occurs, and so it must be re-enabled when the trip is reset.
15	Reserved	

### 10.3 Status word

The SI-PROFIBUS status word consists of sixteen control bits some of which are reserved. See Table 10.3 for the individual bit function descriptions.

**Table 10.3 Status word bit definitions**

b15	b14	b13	b12	b11	b10	b9	b8
(Not used)	Supply loss	Reverse direction running	Reverse direction command	Brake resistor alarm	Braking IGBT active	Regenerating	Current limit active

b7	b6	b5	b4	b3	b2	b1	b0
Rated load reached	Above set speed	At set speed	Below set speed	Running at or below minimum speed	Zero speed	Drive active	Drive OK/ healthy

The fieldbus status word is mapped directly from the drive status word, Pr **10.040**.

Pr **10.040** is generated by the values of several individual drive status bits; Table 10.4 shows the function indicated by each bit in the status word when set to 1.

**Table 10.4 Drive status word bit functions**

Bit	Parameter	Description
0	Pr 10.001	bit 0 = 0: Drive not ok (tripped). bit 0 = 1: Drive ok.
1	Pr 10.002	<b>Drive active</b> When bit 1 = 1, the drive is in run mode.
2	Pr 10.003	<b>Zero speed</b> In Open Loop mode, zero speed indicates that the absolute value of the post-ramp speed reference is at or below the zero speed threshold. In RFC-A and RFC-A modes, zero speed indicates that the absolute value of speed feedback is at or below the zero speed threshold.
3	Pr 10.004	<b>Running at or below minimum speed</b> In bipolar mode (Pr 01.010 = 1) Pr 10.004 is the same as zero speed, Pr 10.003. (See above.) In unipolar mode, Pr 10.004 is set if the absolute value of the post-ramp speed reference (Pr 02.001) or speed feedback (Pr 03.002) is at or below minimum speed + 0.5Hz or 5 rpm. (Minimum speed is defined by Pr 01.007.) This parameter is only set if the drive is running.
4	Pr 10.005	<b>Below set speed</b> Only set if the drive is running at below set speed. Refer to Pr 03.006, Pr 03.007 and Pr 03.009 in the drive documentation for more details.
5	Pr 10.006	<b>At speed</b> Only set if the drive is running at set speed. Refer to Pr 03.006, Pr 03.007 and Pr 03.009 in the drive documentation.
6	Pr 10.007	<b>Above set speed</b> Only set if the drive is running at above set speed. Refer to Pr 03.006, Pr 03.007 and Pr 03.009 in the drive documentation for more details.
7	Pr 10.008	<b>Load reached</b> Indicates that the modulus of the active current is greater or equal to the rated active current, as defined in menu 4. Refer to the drive documentation for more details.
8	Pr 10.009	<b>In current limit</b> Indicates that the current limits are active.
9	Pr 10.010	<b>Regenerating</b> Indicates that power is being transferred from the motor to the drive. Regen mode: Indicates that power is being transferred from the drive to the supply.
10	Pr 10.011	<b>Dynamic brake active</b> Indicates that the braking IGBT is active. If the IGBT becomes active, this parameter will remain on for at least one second.

Bit	Parameter	Description	Safety information	Introduction	Mechanical installation	Electrical installation	Getting started	Parameters	GSD Files	Cyclic data	Non-cyclic data	Control and status words	Diagnostics	PRODrive profile (V4)	Advanced features	Legacy features	Glossary of terms	Index
11	Pr 10.012	<b>Dynamic brake alarm</b> Dynamic brake alarm is set when the braking IGBT is active, and the braking energy accumulator is greater than 75%.																
12	Pr 10.013	<b>Reverse direction commanded</b> Direction commanded is set to 1 if the Pre-ramp speed reference (Pr 01.003) is negative and reset to 0 if the Pre-ramp speed reference is zero or positive.																
13	Pr 10.014	<b>Reverse direction running</b> A 0 indicates forward direction and a 1 indicates reverse direction. The source of this bit is Pr 02.001 for open loop mode and Pr 03.002 for RFC-A and RFC-S modes.																
14	Pr 10.015	<b>Supply loss</b> Supply loss indicates that the drive has detected a supply loss from the level of the DC bus voltage. This parameter can only become active if supply loss ride through or supply loss stop modes are selected. In regen mode, supply loss is the inverse of Pr 03.007.																
15	(Not Used)	<b>Reserved</b>																

---

# 11 Diagnostics

---

## 11.1 Overview

This section provides basic diagnostic information intended to resolve the most common problems encountered when setting up an SI-PROFIBUS module on a PROFIBUS-DP network.

A high percentage of problems reported are basic set-up problem that can be avoided by using the information in this chapter. Start by using the Diagnostic flow chart in Figure 11-1 *Diagnostic flow chart* on page 60, to determine the possible cause of a problem. If after following the flow chart you are still experiencing problems, please contact your supplier or local Control Techniques Drive Centre for support.

**NOTE**

Support is strictly limited to the setting up and networking of the drive.

## 11.2 Drive trip display codes

If the SI-PROFIBUS module detects an error during operation, it will force a trip on the drive. However, the trip string displayed on the drive will only indicate which slot initiated the trip. The exact reason for the trip will be indicated in the drive trip code parameters (Pr 10.020 and Pr 10.070).

Table 11.1 shows the possible trips that will be displayed on the drive when a problem is detected with the SI-PROFIBUS or when the SI-PROFIBUS initiates a trip.

**Table 11.1 Possible drive trip conditions**

Trip	Description
SlotX HF	The drive has detected that an option module is present but is unable to communicate with it due to a hardware fault.
SlotX Error	User trip generated by the SI-PROFIBUS.
SlotX Not installed	This trip will occur if a drive slot was previously configured with an option module but on power up, no option module was detected.
SlotX Different	This trip will occur if a drive slot was previously configured with an option module but on power up, a different option module was detected. Replacing a SI-PROFIBUS module with another one will not initiate this trip. The trip will also occur if a SI-PROFIBUS module is installed to a previously unused slot.



### 11.2.1 Module error codes

If the SI-PROFIBUS detects an error during operation it will force a drive trip. Table 11.2 shows all the possible SI-PROFIBUS error codes.

**Table 11.2 SI-PROFIBUS error codes**

Value	Text	Description
200	No trip	No trip
201	SW fault	Software fault
202	BG overrun	Background task overrun
203	FW invalid	Invalid firmware
204	Drv unknown	Unknown drive type
205	Drv unsupported	Unsupported drive type
206	Mode unknown	Unknown mode
207	Mode unsupported	Unsupported mode
208	FLASH corrupt	Corrupted NV Flash
209	Dbase init	Database initialization error
210	FS init	File system initialization error
211	Memory alloc	Memory allocation error
212	Filesystem	File system error
213	Configuration	Configuration file error
214	Oht	Overheated
215	TO drv	Watchdog timeout
216	eCMP	eCMP comms failure
217	TO eCMP slot 1	Slot 1 eCMP timeout
218	TO eCMP slot 2	Slot 2 eCMP timeout
219	TO eCMP slot 3	Slot 3 eCMP timeout
220	TO eCMP slot 4	Slot 4 eCMP timeout
221	Output overload	Digital output overload

### 11.2.2 PROFIBUS error code

If the SI-PROFIBUS module detects a PROFIBUS error during operation it will force a drive trip. Table 11.3 shows the possible SI-PROFIBUS error codes.

**Table 11.3 SI-PROFIBUS error codes**

Value	Text	Description
100	No trip	No trip
101	Link loss	Network link lost
102	Invalid data	Invalid Fieldbus specific data
103	VPC3 stack	VPC3 stack error

### 11.2.3 SI-PROFIBUS network diagnostic

The operating status of the SI-PROFIBUS module can be viewed in the network diagnostic parameter (Pr **S.01.006**). All possible values of this parameter are described in Table 11.4.

**Table 11.4 SI-PROFIBUS operating status**

<b>Value</b>	<b>Text</b>	<b>Description</b>
<b>0</b>	Network OK	Network OK/healthy.
<b>1</b>	Internal hardware failure	A part of the SI-PROFIBUS initialization sequence was not successful. If this fault persists after a power-cycle, replace the SI-PROFIBUS.
<b>2</b>	Initialized	The SI-PROFIBUS has initialized correctly and is waiting for the Profibus-DP master to initialise communications.
<b>3</b>	Network no data	Network OK/healthy but no network cycles per second detected.
<b>4</b>	First Failure	Mapping configuration fail when mappings are set by input mapping menu and output mapping menu ( <b>S.01.008</b> > 1) or ASCII configuration fail when mappings are set by GSD files ( <b>S.01.008</b> = 0).
<b>5</b>	Second Failure	Mapping configuration fail when mappings are set by input mapping menu and output mapping menu ( <b>S.01.008</b> > 1) or ASCII configuration fail when mappings are set by GSD files ( <b>S.01.008</b> = 0).
<b>6</b>	Third Failure	SI-PROFIBUS does not support CTNC or PPO4 ( <b>S.01.030</b> = 1 or 2), and does not support ProfiDrive V2 ( <b>S.01.008</b> > 2).

### 11.2.4 Mapping status

If the SI-PROFIBUS Network Diagnostic parameter (Pr **S.01.006**) indicates "First Failure" or "Second Failure", a mapping configuration error has been detected. The reason for the error is indicated by the SI-PROFIBUS input mapping status parameter (Pr **S.01.022**) and the SI-PROFIBUS output mapping status parameter (Pr **S.01.023**).

When a mapping error has been corrected, reset the SI-PROFIBUS module by setting **MM.007** to On (1).

The input mapping error codes are described in Table 10.10 and the output mapping error codes are described in Table 11.5 *Input mapping errors* on page 59.

**Table 11.5 Input mapping errors**

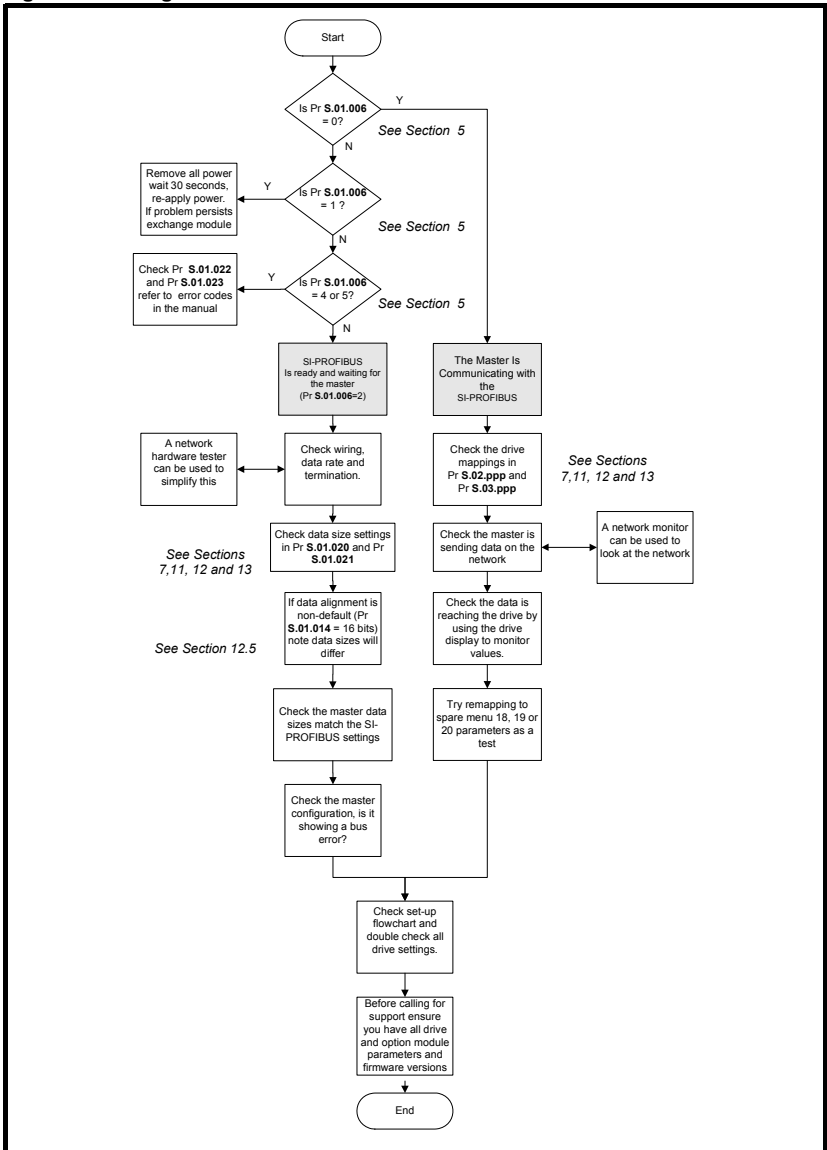
Value	Text	Description
0	No error	No error detected with IN cyclic data mapping configuration.
1	Too many IN objs	Too many IN channels configured
2	No mapping	IN cyclic data length is 0 or there is no IN mapping.
3	Read mismatch	Parameter read error (parameter may not exist)
4	Hole in mappings	IN cyclic data mapping parameters are not contiguous
5	N-C mapping err	A non-cyclic data mode has been mapped more than once in the IN data mapping configuration parameters
6	Duplicate error	Two or more IN cyclic data mapping configuration parameters have been configured with the same destination parameter reference.
7	Length mismatch	Mismatch in data length
8	IN MODE AND PPO	Non-cyclic and PPO STD Tel 1 both exist
9	Data align w PPO	Can't configure PPO when data alignment is set to 32 bits
10	No PPO support	PPO1-PPO5 not supported
11	SP A-D IN map	Input Mapping can't be set by GSD file automatically in SP mode
12	IN AND CTNC PPO4	CTNC and PPO4 not supported

**Table 11.6 Output mapping errors**

Value	Text	Description
0	No error	No error detected with OUT cyclic data mapping configuration.
1	Mapping exceeded	Too many OUT channels configured
2	No mapping	OUT cyclic data length is 0 or there is no OUT mapping.
3	Write mismatch	Parameter write error (parameter may not exist or might be read-only)
4	Hole in mappings	OUT data mapping parameters are not contiguous
5	N-C mapping err	A non-cyclic data mode has been mapped more than once in the OUT data mapping configuration parameters
6	Duplicate error	Two or more OUT cyclic data mapping configuration parameters have been configured with the same destination parameter reference
7	Length mismatch	Mismatch in data length
8	OUT MODE AND PPO	Non-cyclic and PPO STD Tel 1 both exist
9	Data align w PPO	Can't configure PPO when data alignment is set to 32 bits
10	No PPO support	PPO1-PPO5 not supported
11	SP A-D OUT map	Output Mapping can't be set by GSD file automatically in SP mode
12	OUT AND CTNC PPO4	CTNC and PPO4 not supported

Safety information
Introduction
Mechanical installation
Electrical installation
Getting started
Parameters
GSD Files
Cyclic data
Non-cyclic data
Control and status words
Diagnostics
PROFIBUS profile (V4)
Advanced features
Legacy features
Glossary of terms
Index

Figure 11-1 Diagnostic flow chart



# 12 PROFIdrive profile (V4)

## 12.1 What is PROFIdrive profile?

The PROFIdrive profile is a non-vendor specific standard for controlling drives. PROFIdrive allows compatible drives from different vendors to be controlled and monitored using the same control strategy.

For further details of the PROFIdrive profile refer to the official PROFIBUS web-site at [www.profibus.com](http://www.profibus.com).

The SI-PROFIBUS module provides support for the "Standard Drive" application class 1 defined in the PROFIdrive V4 specification for speed control mode using Standard Telegram 1.

SI-PROFIBUS supports the following PROFIdrive features:

- Standard Telegram 1
- PROFIdrive PNU Access
- Drive Identification
- Fault Buffer
- Identification and Maintenance Functions

## 12.2 Standard Telegram 1

To select the Standard Telegrams, the following sequence must be performed:

- Set Pr **S.01.030** to "None" to disable non-cyclic data over the cyclic channel.
- Set Pr **S.01.014** to "16" to set data alignment to 16 bits.
- Set Pr **S.01.008** to "STD Tel 1".
- Pr **S.01.002** or **MM.007** set to "On" to reset the SI-PROFIBUS module.
- Check Pr **S.01.003** does not display any errors (see for further details).
- Save drive parameters (refer to relevant drive documentation for more information).

**NOTE** Pr **S.01.002** or **MM.007** will automatically revert to 'Off' after resetting. Resetting will cause the SI-PROFIBUS to temporary go off-line from the PROFIBUS-DP network.

**NOTE** Once the PROFIdrive profile has been configured the corresponding mapping parameter will display a value of -1 and will be locked; only the user configurable mapping parameters will be editable.

The Standard Telegram 1 support is a mandatory requirement for Application Class 1 devices, the mapping structure is shown Table 12.1.

**Table 12.1 Standard Telegram 1 - mapping structure**

IN Data	Function	OUT Data	Function
word 0	PROFIdrive status word	word 0	PROFIdrive control word
word 1	Main Actual Value	word 1	Main Setpoint

Safety information
Introduction
Mechanical installation
Electrical installation
Getting started
Parameters
GSD Files
Cyclic data
Non-cyclic data
Control and status words
Diagnostics
<b>PROFIdrive profile (V4)</b>
Advanced features
Legacy features
Glossary of terms
Index

## 12.3 Main Setpoint

Main Setpoint is the speed reference defined in the PROFIdrive profile.

It is scaled such that -32768 to +32767 is -200% to +200% of the maximum speed clamp (Pr **01.006**). The converted value is then written to drive digital speed reference 1 (Pr **01.021**).

The formula used for this conversion is:

$$\text{Pr 01.021} = \frac{\text{Main Setpoint} \times \text{Max Speed Clamp}}{16384}$$

### Example 1 - Open loop drive

The drive maximum speed clamp (Pr **1.06**) = 50 Hz

The main setpoint value sent from the master to the drive is 13107

*Giving:*

$$\text{Pr 01.021} = \frac{13107 \times 50}{16384} = 40.0\text{Hz}$$

### Example 2 - Closed loop / servo drive

The drive maximum speed clamp (Pr **1.06**) = 1500 rpm

The main setpoint sent from the master to the drive is 10923

*Giving:*

$$\text{Pr 01.021} = \frac{10923 \times 1500}{16384} = 1000\text{rpm}$$

## 12.4 Main Actual Value

Main Actual Value is the speed feedback reference defined in the PROFIdrive profile.

It is scaled such that -32768 to +32767 is  $\pm 200\%$  of the maximum speed clamp (Pr **01.006**). The converted value is derived from:

- Pr **02.001** for open loop drive operation.
- Pr **03.002 RFC-A** or RFC-S drive operating modes.

The formula used for this conversion is:

$$\text{Main Actual Value} = \frac{\text{SF} \times 16384}{\text{Max Speed Clamp}}$$

Where *SF* is the speed feedback parameter, i.e. Pr **02.001** or Pr **03.002** depending upon the drive operating mode.

### Example 1 - Open loop drive

The drive maximum speed clamp (Pr **01.006**) = 50 Hz

The drive post ramp reference (Pr **02.001**) = 35 Hz

Giving:

$$\text{MAV} = \frac{35 \times 16384}{50} = 11469$$

### Example 2 - RFC-A / RFC-S drive

The speed feedback (Pr **03.002**) = 1000 rpm

The main actual value can be calculated by:

$$\text{MAV} = 1000 \times \frac{16384}{1500} = 10923$$

## 12.5 PROFIdrive (V4) State Machine

The general state machine diagram (V4.0) is shown in Figure 12-1.

The Speed Control state machine is shown in Figure 12-2.

The correct sequence of operation must be used for the state machine otherwise the message will be rejected and the entire sequence must be restarted. The only exception to this rule is when moving from state S2, it is possible to bypass state S3 and jump to state S4 directly.

## 12.6 Normal Run Sequence

The following sequence can be used to get the motor turning (all bit values refer to the PROFIdrive control word):

- Enable network control (bit 10 = 1, 0x0400)
- Remove all STOP commands (bits 1 & 2 = 1, 0x0406: S1 to S2)
- Set drive to Ready (bit 0 = 1, 0x0407: S2 to S3)
- Enable operation (bit 3 = 1, 0x040F: S3 to S4)
- Enable ramp function generator (bit 4 = 1, 0x041F)
- Unfreeze ramp function generator (bit 5 = 1, 0x043F)
- Enable setpoint value (bit 6 = 1, 0x047F)
- Set the main setpoint value in word 1 (Pr **01.021**)

The motor should now accelerate to the speed set by the main setpoint value.

In order to stop the motor, the following options are available:

- Stop the motor using the drive ramp function: set bit 0 to OFF (0x047E) or
- Stop the motor and coast to zero speed: set bit 1 to OFF (0x047D) or
- Stop the motor using 'Quick stop': set bit 2 to OFF (0x047B)
- Disable drive: set bit 3 to OFF (0x0477)

There is a priority control hierarchy when more than the one stop command is given, these priorities are shown in the general state machine diagram and summarized in Table 12.2 on page 64.

Safety information
Introduction
Mechanical installation
Electrical installation
Getting started
Parameters
GSD Files
Cyclic data
Non-cyclic data
Control and status words
Diagnostics
<b>PROFIdrive profile (V4)</b>
Advanced features
Legacy features
Glossary of terms
Index

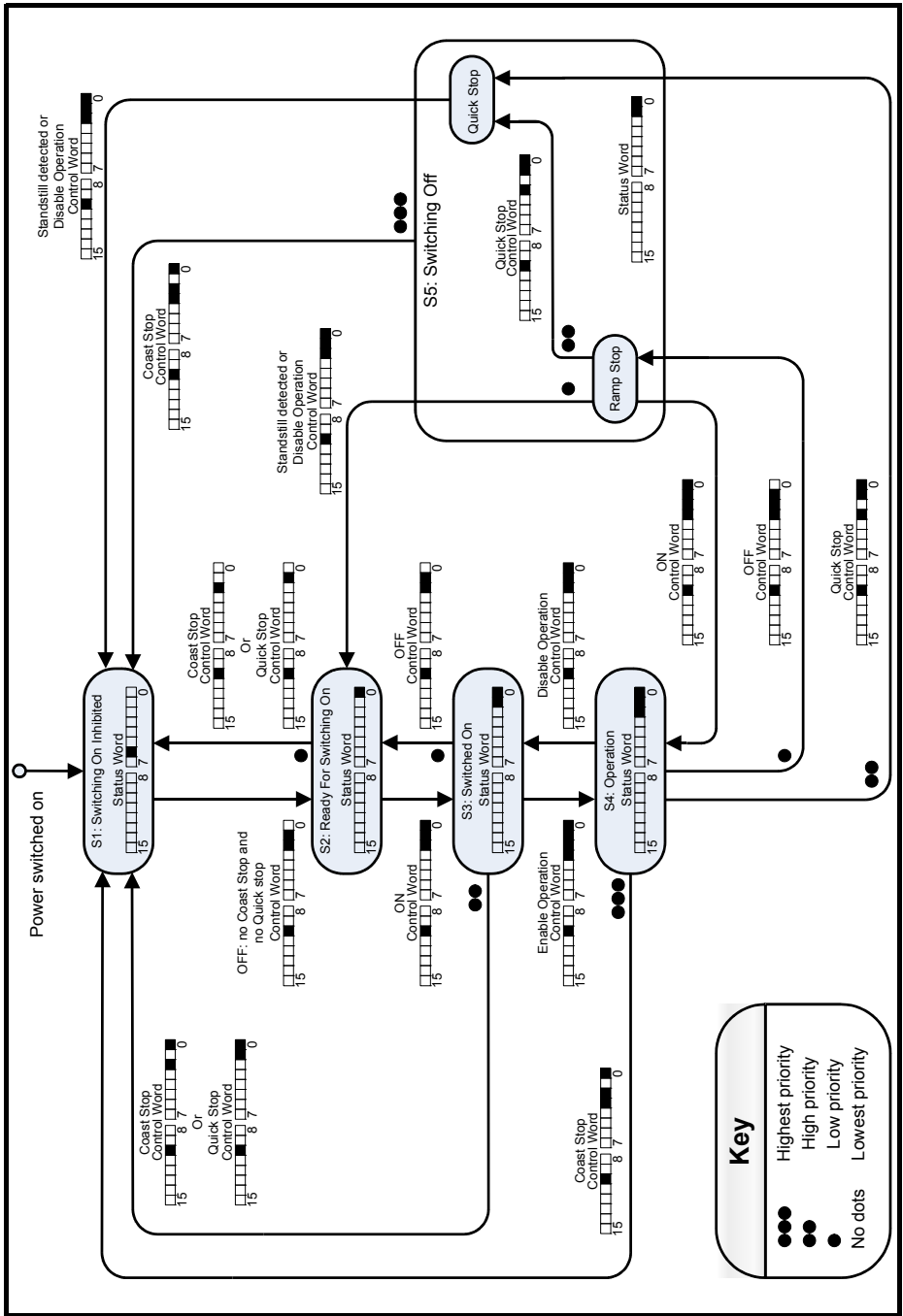
**Table 12.2 Stop command priority**

<b>Priority</b>	<b>Control Word Bit</b>	<b>Stop Command</b>
3 (highest)	1	Coast stop
2 (high)	2	Quick stop (Pr <b>02.022</b> )
1 (low)	0	Ramp stop (Pr <b>02.021</b> )
0 (lowest)	3	Disable Operation

**NOTE** The deceleration rates are set in Pr **02.021** and Pr **02.022** for Ramp Stop and Quick Stop respectively.

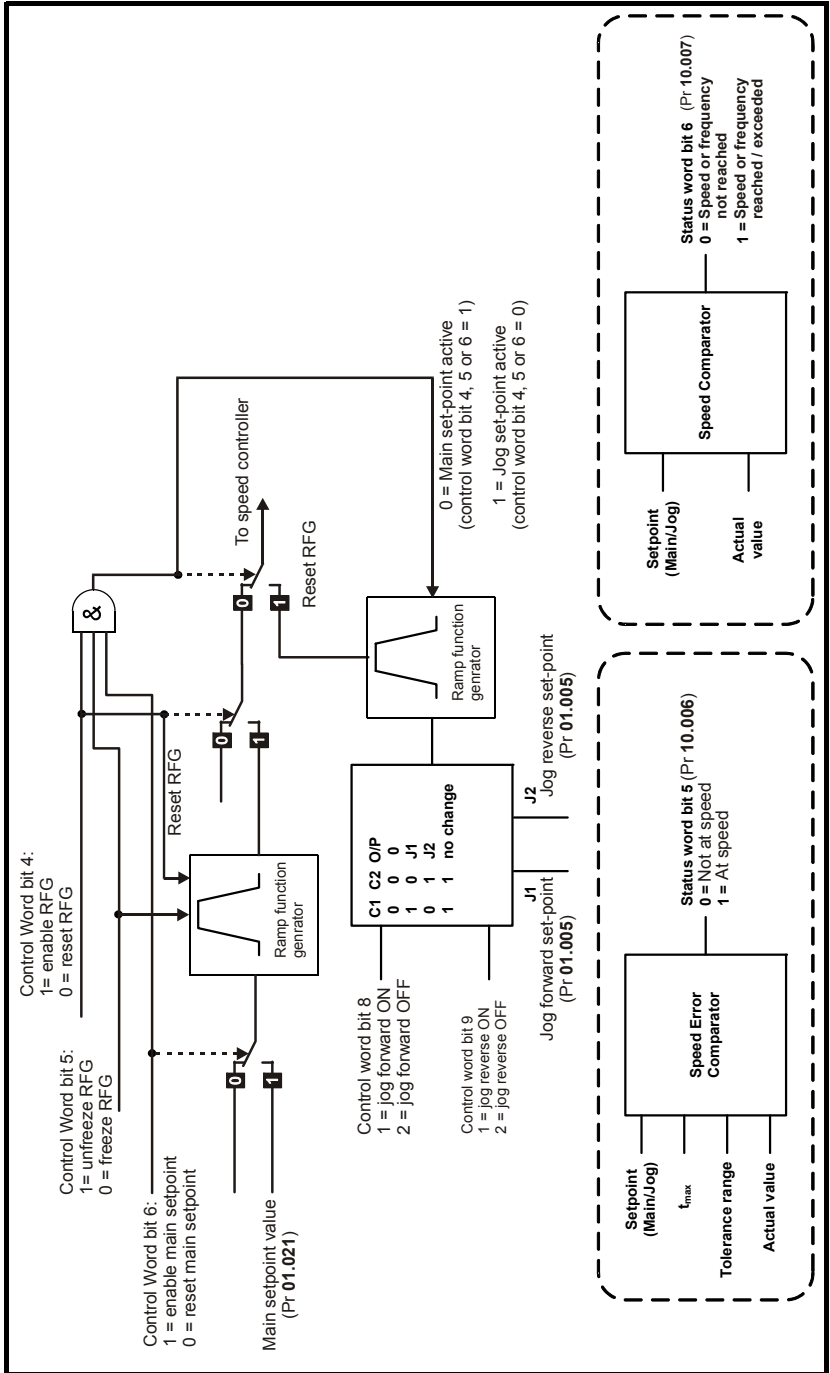


Figure 12-1 PROFdrive V4 General State Machine Diagram



Safety information	Introduction	Mechanical installation	Electrical installation	Getting started	Parameters	GSD Files	Cyclic data	Non-cyclic data	Control and status words	Diagnostics	<b>PROFdrive profile (V4)</b>	Advanced features	Legacy features	Glossary of terms	Index
--------------------	--------------	-------------------------	-------------------------	-----------------	------------	-----------	-------------	-----------------	--------------------------	-------------	-------------------------------	-------------------	-----------------	-------------------	-------

Figure 12-2 PROFIdrive V4 Speed Control State Machine



## 12.7 Stopping the motor using PROFdrive

There are four methods of stopping the motor, these are:

- Disable Operation (control word bit 3) - Drive is inhibited, motor coasts down to zero speed, status set to 'Switched On'.
- Ramp Stop (control word bit 0) - Motor decelerates under ramp control using deceleration rate1 (Pr **02.021**), drive is inhibited, status set to 'Ready For Switching On'.
- Quick Stop (control word bit 2) - Motor decelerates under ramp control using deceleration rate2 (Pr **02.022**), drive is inhibited, status set to 'Switching On Inhibited'.
- Coast Stop (control word bit 1) - Drive is inhibited, motor coasts down to zero speed, status set to 'Switching On Inhibited'.

## 12.8 Jogging

In order to use the jogging functions, the drive must be in the operational state (S4) and at standstill and each of the three bits (4, 5 and 6) of the control word must be set to a 0, if any of these three bits are set to a 1 and the drive is at standstill then the jogging functions are disabled and the main setpoint reference is used. The three control bits (4, 5 and 6) have no effect when in jog mode.

To leave jog mode, both jog bits (8 and 9) must not be active and the drive must be at standstill, the normal control bits (4, 5 and 6) will then be active.

The jog direction is controlled by bit 8 (forward) and bit 9 (reverse) of the control word as illustrated in Figure 12-2.

**NOTE** The jog setpoint is set in Pr **01.005**.

**NOTE** If both jog forward and jog reverse setpoints are selected at the same time (bits 8 and 9 are both set to a 1) then there will be no change to the jog direction. (i.e. if jog forward was previously selected then the motor will continue to jog forward, and if jog reverse was previously selected then the motor will continue to jog in the reverse direction).

The following sequence can be used to jog the motor in the forward direction:

- Enable network control (bit 10 = 1, 0x0400)
- Remove all STOP commands (bits 1 & 2 = 1, 0x0406: S1 to S2)
- Set drive to Ready (bit 0 = 1, 0x0407: S2 to S3)
- Enable operation (bit 3 = 1, 0x040F: S3 to S4)
- Set jog direction forward (bit 8=1 and bit 9=0, 0x050F) or
- Set jog direction reverse (bit 8=0 and bit 9=1, 0x060F)
- Set jog setpoint value (Pr **01.005**)

The motor should now jog at the speed set by the jog setpoint value.

## 12.9 PROFIdrive control word

The PROFIdrive control word consists of sixteen control bits some of which are reserved.

**Table 12.3 PROFIdrive control word bit functions**

Bit	Value	Function	Description
0	1	No Ramp Stop	Ramp Stop command is withdrawn.
	0	Ramp Stop	The motor decelerates under ramp control using deceleration rate1 (Pr <b>02.021</b> ); inhibits the drive and go to 'Ready For Switching On' state.
1	1	No Coast Stop	Coast Stop command is withdrawn.
	0	Coast Stop	Voltage disconnected; inhibit the drive output stage. Main contactor is de-energized (if available), and the drive goes into the 'Switching On Inhibited' status: Motor coasts down
2	1	No Quick Stop	Quick Stop command is withdrawn.
	0	Quick Stop	The motor decelerates under ramp control using deceleration rate2 (Pr <b>02.022</b> ); inhibits the drive and go to 'Switching On Inhibited' state.
3	1	Enable Operation	Enable the drive and accelerate to the specified setpoint.
	0	Disable Operation	Inhibit the drive. Drive coasts down (ramp-function generator to zero or tracking), and into the Switched On' status.
4	1	Enable RFG	Enables the ramp function generator output.
	0	Reset RFG	Ramp function generator output is set to zero. Main contactor remains in, the drive is not isolated from the supply, drive ramps down along the current limit or at the DC bus voltage limit.
5	1	Unfreeze RFG	Unfreezes the ramp function generator output.
	0	Freeze RFG	Freezes the current setpoint from the ramp function generator.
6	1	Enable Setpoint	Selected value at the ramp function generator input is switched in.
	0	Inhibit Setpoint	Selected value at the ramp function generator input is set to 0.
7	1	Fault Acknowledge	Group signal is acknowledged at a positive edge; the drive is in the 'fault' status until the fault has been removed and then goes into 'switch-on inhibit' state.
	0	No meaning	

Bit	Value	Function	Description
8	1	JOG1 ON	Prerequisite: Operation is enabled and Main Setpoint=0. The drive accelerates as fast as possible to jogging setpoint (Pr <b>01.005</b> ) in the forward direction.
	0	JOG1 OFF	The drive brakes as fast as possible along the RFG, if 'JOG1' was previously ON, and goes into 'operation enabled' at standstill.
9	1	JOG2 ON	Prerequisite: Operation is enabled and Main Setpoint=0. The drive accelerates as fast as possible to jogging setpoint (Pr <b>01.005</b> ) in the reverse direction.
	0	JOG2 OFF	The drive brakes as fast as possible along the RFG, if 'JOG2' was previously ON, and goes into 'operation enabled' at standstill.
10	1	Network control	Control from the PROFIBUS-DP network, process (cyclic) data is valid.
	0	No control	Process data invalid. Last received valid process data values are retained.
11-15	0	Reserved	

## 12.10 PROFdrive status word

Table 12.4 gives the description of each bit in the PROFdrive status word.

**Table 12.4 PROFdrive status word bit functions**

Bit	Value	Function	Comments
0	1	Ready to switch on	Power supply switched on, the drive is inhibited.
	0	Not ready to switch on	Power supply switched off.
1	1	Ready To Operate	Drive is ready to run.
	0	Not Ready To Operate	Drive is not ready to run.
2	1	Operation Enabled	Drive is operational.
	0	Operation Disabled	Drive is not operational.
3	1	Fault Present	Drive faulted, and thus not operational, goes into the switch-on inhibit status after acknowledgment and the fault has been removed. Fault number in the fault parameter.
	0	No Fault Present	Drive ok
4	1	Coast Stop Not Activated	Coast Stop command is not active.
	0	Coast Stop Activated	Coast Stop command is active.

Bit	Value	Function	Comments
5	1	Quick Stop Not Activated	Quick Stop command is not active.
	0	Quick Stop Activated	Quick Stop command is active.
6	1	Switch-on Inhibited	Power supply switched on, the drive is inhibited.
	0	Switch-on Not Inhibited	Power supply switched on,
7	1	Warning Present	Not Implemented
	0	No Warning Present	Not Implemented
8	1	Speed Error Within Tolerance	'At Speed' (Pr <b>10.006</b> ) = 1
	0	Speed Error Out Of Tolerance	'At Speed' (Pr <b>10.006</b> ) = 0
9	1	Control Requested	The automation system is requested to accept control.
	0	No Control Requested	Control only possible on the device itself.
10	1	Speed Or Frequency Reached/ Exceeded	'At Speed' (Pr <b>10.006</b> ) = 1 or 'Above Set Speed' (Pr <b>10.007</b> ) = 1
	0	Speed Or Frequency Not Reached	'At Speed' (Pr <b>10.006</b> ) = 0 and 'Above Set Speed' (Pr <b>10.007</b> ) = 0
11-15	0	Reserved	

## 12.11 PROFdrive PNU access

PROFdrive parameters (PNUs) may be accessed by placing the PNU number in the Parameter Index field and any sub-index value should be placed in the Sub-index field of the PROFdrive request.

The full list of supported PROFdrive PNUs is shown in Table 12.5.

**Table 12.5 Supported PROFdrive PNUs**

PNU	Designation	Data type	Access	Explanation
918	PROFIBUS Node ID	Unsigned16	RO	Returns the SI-PROFIBUS network node address.
919	Device system number	Visible string 16	RO	The device system number is a manufacturer specific system ID
922	Telegram selection	Unsigned16	RO	Returns the currently selected telegram
944	Fault message counter	Unsigned16	RO	Incremented by one when the fault buffer changes
947	Fault number	Array(n) Unsigned16	RO	Contains the fault numbers of the recorded faults (see Table 12.6 <i>Fault Buffer Associated PNV's</i> on page 73)
950	Fault buffer scaling	Array(n) Unsigned16	RO	Defines the number of fault situations and the number of faults per situation
963	Actual Baud rate	Unsigned16	RO	This parameter indicates the actual Baud rate
964	Drive Unit ID	Array(n) Unsigned16	RO	Identifies the drive unit
965	Profile ID	Unsigned16	RO	Identifies the PROFdrive profile version
967	Control Word	Unsigned16	WO	Directly maps to the PROFdrive control word
968	Status Word	Unsigned16	RO	Directly maps to the PROFdrive status word
974	Parameter Access Identification	Array(n) Unsigned16	RO	Parameter channel request lengths
975	Drive Object ID	Array(n) Unsigned16	RO	Identifies the drive object
978	List of all DO-IDs	Array(n) Unsigned8	RO	Returns a list of all axis IDs
980-989	Defined parameters list	Array(n) Unsigned16	RO	Each PNU in the range contains an array of PNUs and drive parameters available. Only PNU980 is used and contains an array of parameters starting with the PROFdrive PNUs (excluding PNU980-989) followed by the drive parameters. The array elements are assigned in increasing sequence and consecutively. If an element contains a value of zero then the end of the list has been reached. The array elements are read starting at 0 in increments of 59 elements

Safety information
Introduction
Mechanical installation
Electrical installation
Getting started
Parameters
GSD Files
Cyclic data
Non-cyclic data
Control and status words
Diagnostics
PROFdrive profile (V4)
Advanced features
Legacy features
Glossary of terms
Index

PNU	Designation	Data type	Access	Explanation
1001	Actual value	Unsigned16	RO	Control Techniques specific
1002		Unsigned32	RO	
1003	Setpoint	Unsigned16	WO	
1004		Unsigned32	WO	

**NOTE** It is beyond the scope of this manual to provide information on the PROFIBUS DP-V1 message frame and PROFIdrive PNUs. For more information please refer to the PROFIBUS web-site [www.profibus.com](http://www.profibus.com) or contact your local Control Techniques Drive Centre.

## 12.12 Fault Buffer

The fault buffer provides a list of acknowledged and unacknowledged faults, the buffer contains eight elements numbered from 0 to 7, of which the first element (0) contains the active fault (if any). The remaining elements (1 to 7) contain the acknowledged faults in reverse order of occurrence, and therefore element 1 is the most recent acknowledged fault (last fault) and element 7 is the oldest acknowledged fault (first fault).

Acknowledged faults are faults which have been cleared by resetting the drive when a fault is acknowledged; the fault number will be placed in element 1 of the buffer, any existing recorded faults will be moved up (numerically) one element.

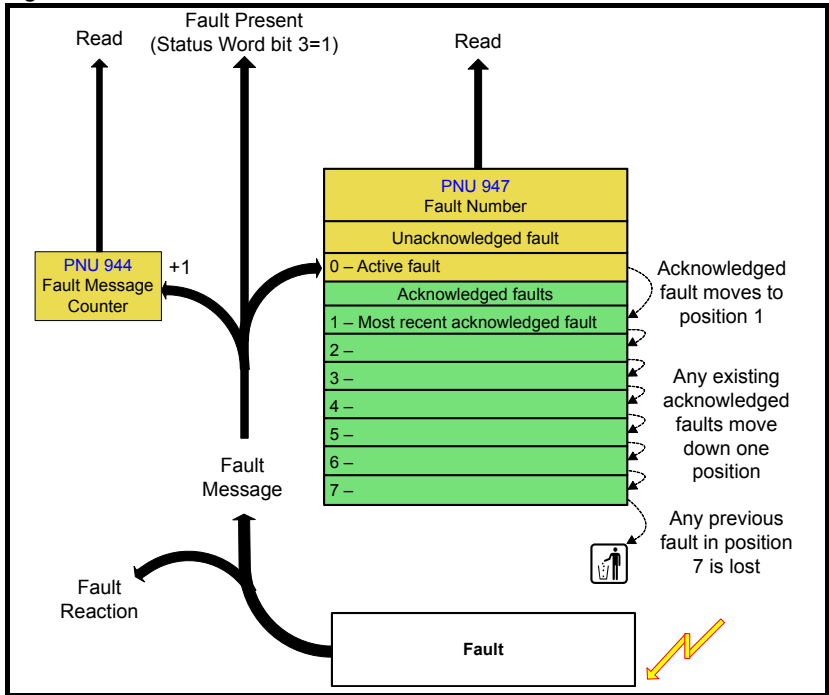
If element 7 already contains a fault number then this will be over-written with the value from position 6, the existing fault number is subsequently lost.

Unacknowledged faults are faults which have not been cleared, currently Control Techniques drives only support one fault of this type, the active fault in Pr **10.020**.

The PROFIdrive fault buffer mechanism is shown in Figure 12-3 on page 73.



**Figure 12-3 DP-V1 Fault Buffer**



**Table 12.6 Fault Buffer Associated PNV's**

PNV	Designation	Description						
944	Fault message counter	Incremented by one when the fault buffer changes						
947	Fault number	Contains the fault numbers of the recorded faults						
		<table border="1"> <thead> <tr> <th>Element</th> <th>Description</th> </tr> </thead> <tbody> <tr> <td>0</td> <td>Last unacknowledged fault (Pr 10.020)</td> </tr> <tr> <td>1 to 7</td> <td>Acknowledged faults in reverse order of occurrence</td> </tr> </tbody> </table>	Element	Description	0	Last unacknowledged fault (Pr 10.020)	1 to 7	Acknowledged faults in reverse order of occurrence
		Element	Description					
0	Last unacknowledged fault (Pr 10.020)							
1 to 7	Acknowledged faults in reverse order of occurrence							
950	Fault buffer scaling	Defines the number of fault situations and the number of faults per situation. (factory set to 8 and 1 respectively)						

**NOTE** The fault buffer contents are stored in internal memory and will be cleared on a module reset or power-down.

## 12.13 Drive Identification

The PROFIdrive specification specifies certain objects that allow network tools to obtain information on the features supported by the slave.

SI-PROFIBUS supports the following PNV's for this purpose.

**Table 12.7 Identification PNV's**

<b>PNV</b>	<b>Designation</b>	<b>Description</b>
964	Drive Unit Identification	Identifies the drive unit
965	Profile Identification	Identifies the PROFIdrive profile version
974	Parameter Access Identification	Parameter channel request lengths
975	Drive Object Identification	Identifies the drive object
978	List of all DO-IDs	Returns a list of all axis IDs

## 12.14 Identification and Maintenance Functions

Identification and Maintenance (I&M) functions assist the user in tracking the drive's life cycle through Commissioning/start-up, parameterization, diagnosis, repair, etc. SI-PROFIBUS supports the following I&M functions:

- I&M0 (Read Only)
- I&M1 (Read/Write)
- I&M2 (Read/Write)
- I&M3 (Read/Write)
- I&M4 (Read/Write)

All I&M functions are available from masters which support this feature.

# 13 Advanced features

## 13.1 SYNC and FREEZE Mode

The SI-PROFIBUS supports the SYNC and FREEZE modes available with most PROFIBUS-DP master controllers.

Cyclic data is put into groups by the PLC allowing multiple cyclic channels to be suspended and updated using the SYNC and FREEZE commands. Data to the drive is controlled by the SYNC command and data from the drive controlled by the FREEZE command. The SYNC command is used in conjunction with the UNSYNC command and the FREEZE command is used in conjunction with the UNFREEZE command.

The SYNC command will cause a single transfer of the previously grouped data and stop any more data from being received by the drive. The SYNC command may be repeated while in this state to allow another single transfer of data to the drive. Issuing an UNSYNC command will revert the drive to continuous cyclic update of the received data.

The FREEZE command will cause a single transfer of the previously grouped data and stop any more data from being transmitted by the drive. The FREEZE command may be repeated while in this state to allow another single transfer of data from the drive. Issuing an UNFREEZE command will revert the drive to continuous cyclic update of the transmitted data.

## 13.2 Inter-option communication timing

When more than one option module is installed to a drive, communications between modules uses inter-option communications. Inter-option communications is slower than the communications directly to the drive parameters.

Typical access times for direct drive menu access will be in the region of 30 $\mu$ s (per parameter), a similar access using inter-option communications will be in the region of 1ms (per parameter).

When using inter-option communications, if parameters are sequential (within the same menu) then up to six parameters may be grouped in to a block, this will take up to 1ms for this block to be transferred. A total of eight blocks for input and eight blocks for output are available.

## 13.3 Multi-master operation

The SI-PROFIBUS can be used on PROFIBUS-DP networks containing one or more master controllers. Consult your master controller documentation for information on how to configure a multi-master PROFIBUS-DP network.

**NOTE** Users must ensure that in networks with multiple master devices that only one master controller is configured to access the SI-PROFIBUS.

**NOTE** SI-PROFIBUS supports the simultaneous connection of one class 1 master and one class 2 master.

Safety information
Introduction
Mechanical installation
Electrical installation
Getting started
Parameters
GSD Files
Cyclic data
Non-cyclic data
Control and status words
Diagnostics
PROFIBUS profile (V4)
<b>Advanced features</b>
Legacy features
Glossary of terms
Index

# 14 Legacy features

## 14.1 Network compatibility mode

Table 14.1 Network compatibility mode

Pr <b>S.01.031</b>	<b>Default</b>	Auto detect (0)
	<b>Range</b>	Auto detect (0) to UniSP extended (3)
	<b>Access</b>	RW

A backwards compatibility mode is present in SI-PROFIBUS. Pr **S.01.031** can be used to allow the SI-PROFIBUS module to appear as a Unidrive SP, this only applies to the network and not the control/status words and parameter sizes. The module must be configured to match the existing network settings of the drive it is replacing (including any parameter mappings).

Table 14.2 Compatibility mode settings

Pr <b>1.01.031</b>	Text	Description
<b>0</b>	Auto detect	Auto detect
<b>1</b>	Unidrive M	Unidrive M mode
<b>2</b>	UniSP	Unidrive SP mode
<b>3</b>	UniSP extended	Unidrive SP Extended Diagnostics Support

Using the compatibility mode allows the replacement of drives on a PROFIBUS-DP network, without having to make any changes to the master network configuration, it changes the identity code of the module so that the master believes that a similar type drive is present for a particular node.

**NOTE** When using compatibility mode, ensure that the correct GSD file for the simulated drive is being used and not the actual drive.



This mode only changes the network to emulate the Unidrive SP on the network. Changes to the control method and data size differences must still be considered. This mode does **NOT** allow direct replacement.

When using extended diagnostics (Pr **1.01.031** = 3), the appropriate GSD file using the correct PROFIBUS identification code (0x0B4F) must be used (e.g. 'SP\_\_0B4F.GSD

For GSD file compatibility please refer to Table 7.1 *Selecting the correct GSD file* on page 43.

## 14.2 PPO Types

SI-PROFIBUS supports all five types of Parameter Process data Object (PPO) defined by the PROFIdrive profile V4. The PROFIdrive profile features four specific functions which the SI-PROFIBUS translates into appropriate drive functions:

- PROFIdrive control word
- Main Setpoint
- PROFIdrive status word
- Main Actual Value

Each PPO mode uses a unique combination of features which are detailed in the following sections.

**NOTE** Do not confuse PPO 4 mode with Mode 2 - PPO 4 word non-cyclic data, they are not the same.

### 14.2.1 PPO 1

**Table 14.3 PPO 1 mapping structure**

IN Data	Function
word 0	Mode 2 non cyclic data (PPO 4-word)
word 1	
word 2	
word 3	
word 4	PROFIdrive status word
word 5	Main Actual Value

OUT Data	Function
word 0	Mode 2 non cyclic data (PPO 4-word)
word 1	
word 2	
word 3	
word 4	PROFIdrive control word
word 5	Main Setpoint

### 14.2.2 PPO 2

**Table 14.4 PPO 2 mapping structure**

IN Data	Function
word 0	Mode 2 non cyclic data (PPO 4-word)
word 1	
word 2	
word 3	
word 4	PROFIdrive status word
word 5	Main Actual Value
word 6	User configurable mapping using Pr <b>S.02.004</b> to Pr <b>S.02.007</b>
word 7	
word 8	
word 9	

OUT Data	Function
word 0	Mode 2 non cyclic data (PPO 4-word)
word 1	
word 2	
word 3	
word 4	PROFIdrive control word
word 5	Main Setpoint
word 6	User configurable mapping using Pr <b>S.03.004</b> to Pr <b>S.03.007</b>
word 7	
word 8	
word 9	

### 14.2.3 PPO 3

Table 14.5 PPO 3 mapping structure

IN Data	Function
word 0	PROFIdrive status word
word 1	Main Actual Value

OUT Data	Function
word 0	PROFIdrive control word
word 1	Main Setpoint

### 14.2.4 PPO 4

Table 14.6 PPO 4 mapping structure

IN Data	Function
word 0	PROFIdrive status word
word 1	Main Actual Value
word 2	User configurable mapping using Pr <b>S.02.003</b> to Pr <b>S.02.006</b>
word 3	
word 4	
word 5	

OUT Data	Function
word 0	PROFIdrive control word
word 1	Main Setpoint
word 2	User configurable mapping using Pr <b>S.03.003</b> to Pr <b>S.03.006</b>
word 3	
word 4	
word 5	

### 14.2.5 PPO 5

Table 14.7 PPO 5 mapping structure

IN Data	Function
word 0	Mode 2 non cyclic data (PPO 4-word)
word 1	
word 2	
word 3	
word 4	PROFIdrive status word
word 5	Main Actual Value
word 6	User configurable mapping using Pr <b>S.02.004</b> to Pr <b>S.02.020</b>
word 7	
word 8	
word 9	
word 10	
word 11	
word 12	
word 13	

OUT Data	Function
word 0	Mode 2 non cyclic data (PPO 4-word)
word 1	
word 2	
word 3	
word 4	PROFIdrive control word
word 5	Main Setpoint
word 6	User configurable mapping using Pr <b>S.03.004</b> to Pr <b>S.03.020</b>
word 7	
word 8	
word 9	
word 10	
word 11	
word 12	
word 13	

## 14.3 Configuring the Profile

To configure the profile to the required PPO mode use the following sequence:

- Set Pr **S.01.014** to 16 to enable data alignment
- Set Pr **S.01.008** to the required PPO profile PP01 to PP05 (5 to 9).
- Configure the mapping parameters as required
- Set **mm.000** to Save parameters or 1000 and press the reset button.
- **S.01.002** or Pr **MM.007** set to On to reset SI-PROFIBUS
- Check Pr **S.01.006** doesn't indicate a fault (see for further details)

Save the drive parameters (refer to the relevant drive documentation for more information).

**NOTE** Pr **S.01.002** or Pr **MM.007** will automatically reset to Off when the process is complete.

**NOTE** Once the PROFdrive profile has been configured the corresponding mapping parameter will display a value of -1 and will be locked; only the user configurable mapping parameters will be editable.

If the PROFdrive profile has been configured after settings have already been made to the cyclic data mapping parameters, the first two or three mapping parameters (depending upon the PPO type chosen) will be over written and locked out.

## 14.4 Setting the non-cyclic mode (non-cyclic over cyclic)

Sending non-cyclic data over the cyclic channel can only be accomplished when the SI-PROFIBUS module is set up for a Unidrive SP in compatibility mode (Pr **S.01.031** = 2 or 3) and the correct GSD file loaded. The correct GSD file for the simulated drive (e.g. SP\_\_0672.GSD)

The term 'non-cyclic over cyclic' is used to refer to non-cyclic data which is transmitted as part of the cyclic data and not using the non-cyclic DP-V1 channel.

Table 14.8 shows how to configure the non-cyclic over cyclic parameter (Pr **S.01.030**) for the required non-cyclic mode.

**Table 14.8 Non-cyclic over cyclic data modes**

Value	Text	Description
0	None	
1	CTNC	1 Non-cyclic word (CT Single Word mode 1)
2	PPO defined	4 Non-cyclic words (PPO 4 Word mode 2)

## 14.5 Mode 1 - CT Single Word mode

The CT Single Word (Mode 1) uses one cyclic channel for non-cyclic data. This non-cyclic sub-protocol requires a specific sequence of four or six telegrams to implement the parameter access. Each non-cyclic word or telegram is split into two bytes to implement the sub-protocol. The high byte containing the control codes for each telegram and the low byte containing the data for each telegram.

**NOTE** By default cyclic data alignment is set to 32 bits, the CT Single Word non-cyclic channel will be 32 bits wide (i.e. uses two words, and data must be transferred on the low word). If cyclic data alignment is set to 16, the CT Single Word non-cyclic channel will revert to 16 bits and only use a single word.

### 14.5.1 Mapping For CT Single Word non-cyclic data

To configure an SI-PROFIBUS for CT Single Word mode the following steps must be performed:

1. Set Pr **S.01.030** to the required mode.
2. Save the parameters if required.
3. Set **S.01.002** or Pr **MM.007** to ON to reset.

When the SI-PROFIBUS resets, it will map cyclic data IN Word 0 and cyclic data OUT Word 0 to the CT Single Word protocol parameter. All existing mapping parameters will be moved down by one word, (i.e. the previous mappings set in Pr **S.02.001** and Pr **S.03.001** will now appear in Pr **S.02.002** and Pr **S.03.002** etc.). Table 14.9 shows what happens to the mappings when the data format is changed from four cyclic words to four cyclic words with CT Single Word non-cyclic data.

**Table 14.9 CT Single Word non-cyclic data mapping**

Mapping parameter	Before format change (Pr S.01.030 = 0)		After format change (Pr S.01.030 = 1)	
	Value	Mapping	Value	Mapping
Pr <b>S.02.001</b>	10040	Pr <b>10.040</b> , status word		Pr <b>61.050</b> , CT Single Word
Pr <b>S.02.002</b>	2001	Pr <b>02.001</b> , post ramp speed ref	10040	Pr <b>10.040</b> , status word
Pr <b>S.02.003</b>	0	Not mapped	2001	Pr <b>02.001</b> , post ramp speed ref
Pr <b>S.02.004</b> to Pr <b>S.02.032</b>	0	Not mapped	0	Not mapped
Pr <b>S.03.001</b>	6042	Pr <b>06.042</b> , control word		Pr <b>61.050</b> , CT Single Word
Pr <b>S.03.002</b>	1021	Pr <b>01.021</b> , digital speed ref 1	6042	Pr <b>06.042</b> , control word
Pr <b>S.03.003</b>	0	Not mapped	1021	Pr <b>01.021</b> , digital speed ref 1
Pr <b>S.03.004</b> to Pr <b>S.03.032</b>	0	Not mapped	0	Not mapped

**NOTE** If all IN or OUT mapping parameters are being used when the data format change is implemented the last mapping parameter value will be lost.

### 14.5.2 CT Single Word protocol

All parameter values for the drive must be written as signed 32-bit data values with data alignment set to 32 bits. If data alignment is set to 16, the size of the mapping will depend on the size of the source or destination parameter.

**NOTE** Decimal point information is inserted automatically when the data value is written to the drive and removed when the data value is read. The number of decimal places of the target parameter must be known. Writing a value of 1234 to a parameter with two decimal places will produce a value of 12.34 in the target parameter. Similarly, reading a value of 12.34 will return a 32-bit integer value of 1234.



**Table 14.10 CT Single Word Bit Positions**

<b>b15</b>	<b>b14</b>	<b>b13</b>	<b>b12</b>	<b>b11</b>	<b>b10</b>	<b>b9</b>	<b>b8</b>
READ	ERR	Reserved	32-BIT	Stamp Number			
<b>b7</b>	<b>b6</b>	<b>b5</b>	<b>b4</b>	<b>b3</b>	<b>b2</b>	<b>b1</b>	<b>b0</b>
Data Byte							

**Table 14.11 CT Single Word Bit Definitions**

Bit	Function	Values	Description
0 to 7	Data	0 to 255	Depending on the stamp number of the telegram, this byte contains the menu, parameter or data byte.
8 to 11	Stamp number	0 to 6	Indicates the stamp number of the word. This shows which part of the message is currently in progress. Setting the stamp number to 0 resets the internal non-cyclic state machine.
12	32-BIT	0 = 16-bit data 1 = 32-bit data	Specifies whether a 16-bit or 32-bit data value is to be written to or read from the drive. If 32-BIT is set, telegrams 5 and 6 will be used to transfer the additional data bytes.
13	Reserved	0	Reserved for future use. Always set to 0.
14	ERR	0 = Data OK 1 = Error	Indicates the success or failure of the message. Failure could occur if the parameter does not exist, or is a read-only or write-only parameter. This bit will also be set if the parameter value is out of range in 16-bit mode.
15	READ	0 = Write 1 = Read	Defines whether the data word is part of a READ or WRITE cycle.

**NOTE** Setting the stamp number to 0 resets the internal non-cyclic state machine. Allowing a new message to be started.

**NOTE** CT Single Word non-cyclic data uses only one word of data, when using this with data alignment set to 32 requires two 16-bit words. In this mode only the least significant word of the 32-bit word is used.

## 14.6 Reading parameters using CT Single Word

To read 32-bit parameters using the non-cyclic channel, the following “telegrams” must be transmitted to construct the final message:

- Telegram 1 - define menu number
- Telegram 2 - define parameter number
- Telegram 3 - request high data byte
- Telegram 4 - request mid-high data byte
- Telegram 5 - request mid-low data byte
- Telegram 6 - request low data byte

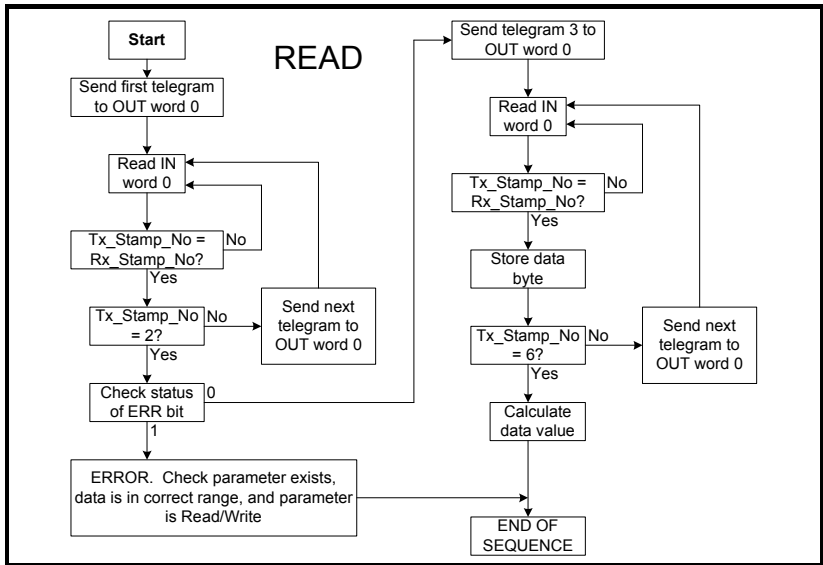
Safety information
Introduction
Mechanical installation
Electrical installation
Getting started
Parameters
GSD Files
Cyclic data
Non-cyclic data
Control and status words
Diagnostics
PROFIBUS profile (V4)
Advanced features
Legacy features
Glossary of terms
Index

**Table 14.12 CT Single Word Bit Positions**

<b>b15</b>	<b>b14</b>	<b>b13</b>	<b>b12</b>	<b>b11</b>	<b>b10</b>	<b>b9</b>	<b>b8</b>
READ	ERR	Reserved	32-BIT	Stamp Number			
<b>b7</b>	<b>b6</b>	<b>b5</b>	<b>b4</b>	<b>b3</b>	<b>b2</b>	<b>b1</b>	<b>b0</b>
Data Byte							

**14.6.1 Constructing CT Mode 1 Single Word Read Messages**

**Figure 14-1 CT Single Word read sequence (Mode 1)**



The following example telegrams show how to read the post-ramp speed reference (in rpm with one decimal places) from Pr **02.001** on the drive.

**TELEGRAM 1**

The first telegram from the PROFIBUS-DP master indicates a READ with stamp number 1. The data byte contains the menu number of the parameter that is to be read.

**Example telegram**

Bit	b15-b12	b11-b8	b7-b4	b3-b0
Value	1001	0001	0000	0010

**Data word = 0x9102**

**Stamp number = 1**

**Menu = 2**

When the first telegram has been received and processed in the slave node, it is mirrored in the non-cyclic IN word back to the PLC. This is the signal to the master controller program that the first telegram of the message has been received and understood the second telegram can now be transmitted.

### Example response

Bit	b15-b12	b11-b8	b7-b4	b3-b0
Value	1001	0001	0000	0010

**Data word = 0x9102**

**Stamp number = 1**

**NOTE** If a telegram produces an error at any point in the sequence the reply to the master will have the error bit ERR set to a 1.

### TELEGRAM 2

The second telegram from the PROFIBUS-DP master also indicates a READ cycle, but the stamp number is now 2. The data byte would contain the parameter number for the parameter that is to be read.

### Example telegram

Bit	b15-b12	b11-b8	b7-b4	b3-b0
Value	1001	0010	0000	0001

**Data word = 0x9201**

**Stamp number = 2**

**Parameter = 1**

*When the second telegram has been received and processed in the slave, it is mirrored in the non-cyclic IN word. This is the signal to the master controller program that the second telegram of the message has been received and the third telegram can now be transmitted.*

**NOTE** If telegrams 1 and 2 were not received correctly or an invalid parameter was specified, (e.g. parameter is write only, or does not exist), the PROFIBUS-DP interface will set the ERROR bit to 1 (b14 = 1) in the response. The data bits will have no significance. Setting the stamp number to 0 resets the internal non-cyclic state machine.

### Example response

Bit	b15-b12	b11-b8	b7-b4	b3-b0
Value	1001	0010	0000	0001

**Data word = 0x9201**

**Stamp number = 2**

**NOTE** If an error is reported, the non-cyclic data word should be set to 0 to ensure that the non-cyclic state machine is completely reset and ready for the next non-cyclic READ or WRITE sequence.

Safety information
Introduction
Mechanical installation
Electrical installation
Getting started
Parameters
GSD Files
Cyclic data
Non-cyclic data
Control and status words
Diagnostics
PROFdrive profile (V4)
Advanced features
Legacy features
Glossary of terms
Index

### TELEGRAM 3

The third telegram from the PROFIBUS-DP master acts as the indication to the slave to send the high data byte from the requested parameter. The data byte is not used in this telegram, and should be set to 0.

#### Example telegram

Bit	b15-b12	b11-b8	b7-b4	b3-b0
Value	1001	0011	0000	0000

**Data word = 0x9300**

**Stamp number = 3**

When the third telegram has been received and processed in the slave node, the node will mirror the stamp number in the non-cyclic IN word and load the high byte of the parameter value into the data byte.

#### Example response

Bit	b15-b12	b11-b8	b7-b4	b3-b0
Value	1001	0011	0000	0000

**Data word = 0x9300**

**Stamp number = 3**

**Data high byte = 0x00 = 0**

### TELEGRAM 4

The fourth telegram from the PROFIBUS-DP master acts as the indication to the slave to send the mid-high data byte from the requested parameter. The data byte is not used in this telegram, and should be set to 0.

#### Example telegram

Bit	b15-b12	b11-b8	b7-b4	b3-b0
Value	1001	0100	0000	0000

**Data word = 0x9400**

**Stamp number = 4**

When the fourth telegram has been received and processed in the slave node, the node will mirror the stamp number in the non-cyclic IN word and load the mid-high byte of the parameter value into the data byte.

#### Example response

Bit	b15-b12	b11-b8	b7-b4	b3-b0
Value	1001	0100	0000	0001

**Data word = 0x9401**

**Stamp number = 4**

**Data mid-high byte = 0x01 = 1**

## TELEGRAM 5

The fifth telegram from the PROFIBUS-DP master acts as the indication to the slave to send the mid-low data byte from the requested parameter. The data byte is not used in this telegram and should be set to 0.

### Example telegram

Bit	b15-b12	b11-b8	b7-b4	b3-b0
Value	1001	0101	0000	0000

**Data word = 0x9500**

**Stamp number = 5**

When the fifth telegram has been received and processed in the slave node, the node will mirror the stamp number in the non-cyclic IN word and load the mid-low byte of the parameter value into the data byte.

### Example response

Bit	b15-b12	b11-b8	b7-b4	b3-b0
Value	1001	0101	0010	0101

**Data word = 0x9525**

**Stamp number = 5**

**Data mid-low byte = 0x25 = 37**

## TELEGRAM 6

The sixth telegram from the PROFIBUS-DP master acts as the indication to the slave to send the low data byte from the requested parameter. The data byte is not used in this telegram and should be set to 0.

### Example telegram

Bit	b15-b12	b11-b8	b7-b4	b3-b0
Value	1001	0110	0000	0000

**Data word = 0x9600**

**Stamp number = 6**

When the sixth telegram has been received and processed in the slave node, the node will mirror the stamp number in the non-cyclic IN word and load the low byte of the parameter value into the data byte.

### Example response

Bit	b15-b12	b11-b8	b7-b4	b3-b0
Value	1001	0110	1101	1100

**Data word = 0x96DC**

**Stamp number = 6**

**Data low byte = 0xDC = 220**

## 14.6.2 The parameter re-assembled

The completed value can be assembled as follows to give the complete value as read from the parameter.

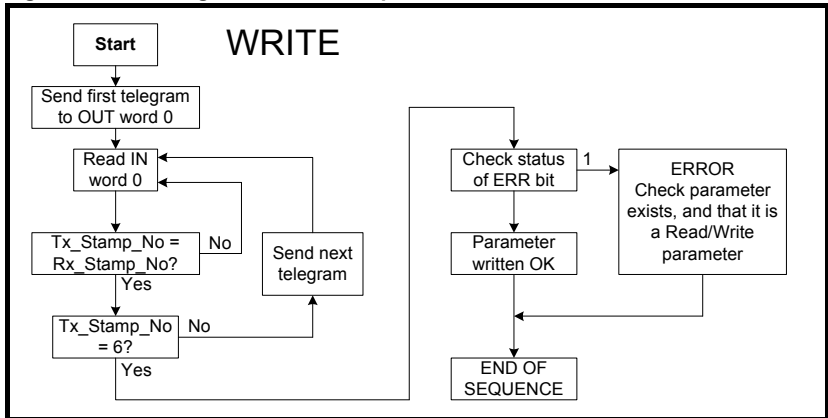
$$\begin{aligned} \text{Speed} &= (\text{High byte} * 2^{24}) + (\text{Mid-high byte} * 2^{16}) + \\ &\quad (\text{Mid-low byte} * 2^8) + \text{Low byte} \\ &= (0 * 16777216) + (1 * 65536) + (37 * 256) + 220 \\ &= 75228 \\ &= 7522.8 \text{ rpm} \end{aligned}$$

## 14.6.3 Writing parameters using CT Single Word

To write to a 32-bit parameter using the non-cyclic channel, the following telegrams must be sent one telegram per network cycle to construct the final message.

- Telegram 1 - define menu number
- Telegram 2 - define parameter number
- Telegram 3 - send high data byte
- Telegram 4 - send mid-high data byte
- Telegram 5 - send mid-low data byte
- Telegram 6 - send low data byte

Figure 14-2 CT Single Word write sequence



The following telegrams show how to set the digital speed reference 1 (Pr **01.021**) to 12553.9 rpm (32-bit value is 125539) in the Unidrive SP.

## TELEGRAM 1

The first telegram from the PROFIBUS-DP master indicates a WRITE cycle by setting the R/W bit to 0. The stamp number is set to 1. The data byte contains the menu number for the parameter that is to be written to.

### Example telegram

Bit	b15-b12	b11-b8	b7-b4	b3-b0
Value	0001	0001	0000	0001

**Data word = 0x1101**

**Stamp number = 1**

**Menu = 1**

When the first telegram has been received and processed in the slave node, it is mirrored in the non-cyclic IN word. This is the signal to the master controller program that the first telegram of the message has been received and understood and the second telegram can be transmitted.

## TELEGRAM 2

The second telegram from the PROFIBUS-DP master also indicates a write cycle, but the stamp number is now set to 2. The data byte would contain the parameter number for the parameter that is to be written to

### Example telegram

Bit	b15-b12	b11-b8	b7-b4	b3-b0
Value	0001	0010	0001	0101

**Data word = 0x1215**

**Stamp number = 2**

**Parameter = 21**

When the second telegram has been received and processed in the slave node, it is mirrored in the non-cyclic IN word. This is the signal to the master controller program that the second telegram of the message has been received and understood and the third telegram can be transmitted.

## TELEGRAM 3

The third telegram from the PROFIBUS-DP master has the stamp number set to 3. The data bits contain the high data byte for the parameter being written to.

### Example telegram

Bit	b15-b12	b11-b8	b7-b4	b3-b0
Value	0001	0011	0000	0000

**Data word = 0x1300**

**Stamp number = 3**

**Data high byte = 0x00**

When the third telegram has been received and processed in the slave node, it is mirrored in the non-cyclic IN word. This is the signal to the master controller program that the third telegram of the message has been received and understood and the fourth telegram can be transmitted.

Safety information
Introduction
Mechanical installation
Electrical installation
Getting started
Parameters
GSD Files
Cyclic data
Non-cyclic data
Control and status words
Diagnostics
PROFdrive profile (V4)
Advanced features
Legacy features
Glossary of terms
Index

## TELEGRAM 4

The fourth telegram from the PROFIBUS-DP master has the stamp number set to 4. The data bits contain the mid-high data byte for the parameter being written to.

### Example telegram

Bit	b15-b12	b11-b8	b7-b4	b3-b0
Value	0001	0100	0000	0001

**Data word = 0x1401**

**Stamp number = 4**

**Data mid-high byte = 0x01 = 1**

When the fourth telegram has been received and processed in the slave node, it is mirrored in the non-cyclic IN word. This is the signal to the master controller program that the fourth telegram of the message has been received and understood and the fifth telegram can be transmitted.

## TELEGRAM 5

The fifth telegram from the PROFIBUS-DP master has the stamp number set to 5. The data bits contain the mid-low data byte for the parameter being written to.

### Example telegram

Bit	b15-b12	b11-b8	b7-b4	b3-b0
Value	0001	0101	1110	1010

**Data word = 0x15EA**

**Stamp number = 5**

**Data mid-low byte = 0xEA = 234**

When the fifth telegram has been received and processed in the slave node, it is mirrored in the non-cyclic IN word. This is the signal to the master controller program that the fifth telegram of the message has been received and understood and the sixth telegram can be transmitted.

## TELEGRAM 6

The sixth telegram from the PROFIBUS-DP master has the stamp number set to 6. The data bits contain the low data byte for the parameter that is being written to.

### Example telegram

Bit	b15-b12	b11-b8	b7-b4	b3-b0
Value	0001	0110	0110	0011

**Data word = 0x1663**

**Stamp number = 6**

**Data low byte = 0x63 = 99**

When the sixth telegram has been received and processed in the slave node, it will write the data (Pr **01.021** = 12553.9) as transmitted (the decimal point is automatically inserted when the data is transferred to the drive). If the operation is successful, the ERR bit is reset to 0 and the telegram is reflected in the non-cyclic IN word.



#### Example response - success

Bit	b15-b12	b11-b8	b7-b4	b3-b0
Value	0001	0110	0110	0011

**Data word = 0x1663**

**Stamp number = 6**

**Data low byte = 0x63 = 99**

If there was a problem with writing the data to the defined parameter, e.g. parameter is read only, does not exist, or data is out of range, the ERR bit is set to 1.

#### Example response - success

Bit	b15-b12	b11-b8	b7-b4	b3-b0
Value	0101	0110	0110	0011

**Data word = 0x5663**

**Stamp number = 6**

### 14.6.4 Abort CT Single Word non-cyclic message

The internal state machine that controls the non-cyclic data transfer will only accept a new telegram if it contains the next expected telegram (i.e. after accepting Telegram 2, the state machine will only respond to Telegram 3. If Telegram 4 is received, it will be ignored).

If an error occurs in the master controller that causes the telegrams to get out of step, the master controller program should time-out, abort the message and reset the non-cyclic state machine.

A Mode 1 non-cyclic message can be abandoned by resetting the state machine. This is done by setting the non-cyclic word to 0.

#### Example telegram

Bit	b15-b12	b11-b8	b7-b4	b3-b0
Value	0000	0000	0000	0000

**Data word = 0x0000**

**Stamp number = 0**

### 14.6.5 16-bit parameter access

Normally six telegrams would be required to access drive parameters using Mode 1 non-cyclic data. When accessing 16-bit data only four telegrams are required. If an attempt is made to read a 32-bit parameter from the drive the parameter value will be returned, provided that the parameter value does not exceed signed 16-bit limits. If the value is larger than a signed 16-bit value, the ERR bit will be set. When writing data to a 32-bit parameter, the 16-bit data will be treated as a signed 16-bit data value. This limits the range that can be written to a 32-bit parameter.

Safety information
Introduction
Mechanical Installation
Electrical Installation
Getting started
Parameters
GSD Files
Cyclic data
Non-cyclic data
Control and status words
Diagnostics
PRODrive profile (V4)
Advanced features
Legacy features
Glossary of terms
Index

## 14.7 Mode 2 - PPO 4 Word mode

PPO 4 word mode of non-cyclic data is a simple method of accessing non-cyclic data without the need for the telegrams required with Mode 1 non-cyclic data and its associated overheads. Mode 2 has the disadvantage of using four words of mappings and reduces the available free mappings accordingly.

### 14.7.1 Mapping for PPO 4 Word non-cyclic data

To configure an SI-PROFIBUS for PPO 4 word mode non-cyclic data, the following steps must be performed:

1. Set Pr **S.01.030** to the required mode (see ).
2. Set Pr **MM.007** to ON to re-initialize SI-PROFIBUS.
3. Save the parameters if required (see for more information).

When the SI-PROFIBUS resets, it will map cyclic data IN words 0 to 3 and OUT words 0 to 3 to the PPO 4 Word protocol parameter. All existing mapping parameters will be moved down by one mapping, (i.e. the previous mappings set in Pr **S.02.001** and Pr **S.03.001** will now appear in Pr **S.02.002** and Pr **S.03.002** respectively). Table 14.13 shows what happens to the mapping parameters when the data format is changed from sending no cyclic data over the cyclic channel (Pr **S.01.030**=0) to sending non-cyclic data over the cyclic channel with Mode 2 non-cyclic data. (Pr **S.01.030**=2).

**Table 14.13 PPO 4 Word mode data mapping**

Mapping parameter	Before format change (Pr <b>S.01.030</b> = 0)		After format change (Pr <b>S.01.030</b> = 2)	
	Value	Mapping	Value	Mapping
Pr <b>S.02.001</b>	10040	Pr <b>10.040</b> , status word		Pr <b>61.051</b> , PPO 4 Word
Pr <b>S.02.002</b>	2001	Pr <b>02.001</b> , post ramp speed ref	10040	Pr <b>10.040</b> , status word
Pr <b>S.02.003</b>	0	Not mapped	2001	Pr <b>02.001</b> , post ramp speed ref
Pr <b>S.02.004</b> to Pr <b>S.02.032</b>	0	Not mapped	0	Not mapped
Pr <b>S.03.001</b>	6042	Pr <b>06.042</b> , control word		Pr <b>61.051</b> , PPO 4 Word
Pr <b>S.03.002</b>	1021	Pr <b>01.021</b> , digital speed ref 1	6042	Pr <b>06.042</b> , control word
Pr <b>S.03.003</b>	0	Not mapped	1021	Pr <b>01.021</b> , digital speed ref 1
Pr <b>S.03.004</b> to Pr <b>S.03.032</b>	0	Not mapped	0	Not mapped

**NOTE**

If all IN or OUT mapping parameters are being used when the data format change is implemented, the last mapping parameter value will be lost.

## 14.7.2 PPO 4 Word protocol

Table 14.14 shows the data structure required on the OUT data to implement PPO 4 Word request.

**NOTE** Decimal point information is inserted automatically when the data value is written to the drive and removed when the data value is read. Hence the number of decimal places of the target parameter must be known. Writing a value of 1234 to a parameter with two decimal places will produce a value of 12.34 in the target parameter. Similarly reading a value of 12.34 will return a 32-bit integer value of 1234.

**Table 14.14 PPO 4 Word OUT data structure**

OUT data word	Function			
	b15-b12	b11	b10-b8	b7-b0
OUT word 0	TASK ID	0	MENU	
OUT word 1	PARAMETER		Reserved	
OUT word 2	DATA HIGH word			
OUT word 3	DATA LOW word			

The PPO 4 Word protocol is controlled by the TASK ID and RESPONSE ID; the TASK ID specifies the transaction required and the remainder of the data words carry the data for the transaction. Table 14.15 lists the possible TASK ID codes.

**Table 14.15 TASK ID codes**

TASK ID	Function	Description
0	No task	No non-cyclic transaction required
1	Fieldbus specific	
2	Fieldbus specific	
3	Fieldbus specific	
4	Not implemented	Reserved
5	Not implemented	Reserved
6	Request parameter value	Read parameter value from drive. Specify MENU and PARAMETER, set DATA HIGH word and DATA LOW word to 0.
7	Change parameter value (16-bit)	Write 16-bit parameter value to the drive. Specify MENU, PARAMETER and DATA LOW word. (Any value in DATA HIGH word will be discarded.) This function can be used to write to 32-bit drive parameters, but the range of values is limited to 16 bits.
8	Change parameter value (32-bit)	Write 32-bit parameter value to the drive. Specify MENU, PARAMETER, DATA HIGH word and DATA LOW word. This function can also be used to write to 16-bit drive parameters, but if DATA HIGH word is not set to 0, a value over-range error will be reported.
9	Request last parameter reference	Returns the last parameter for the specified menu. Specify MENU. (Values in PARAMETER, DATA HIGH word and DATA LOW word will be discarded.)

Table 14.16 shows the data structure of a PPO 4 Word response that will be returned by SI-PROFIBUS.

**Table 14.16 PPO 4 Word IN data structure**

IN data word	Function			
	b15-b12	b11	b10-b8	b7-b0
IN word 0	RESPONSE ID	0	MENU	
IN word 1	PARAMETER			
IN word 2	DATA HIGH word			
IN word 3	DATA LOW word			

The RESPONSE ID indicates the success or otherwise of the requested transaction. Table 14.7 lists the possible RESPONSE ID codes.

**Table 14.17 RESPONSE ID codes**

RESPONSE ID	Function	Description
0	No task	No non-cyclic transaction active
1	Fieldbus specific	
2	Fieldbus specific	
3	Not implemented	
4	Transfer parameter value (16-bit)	Returns a 16-bit data value from the request parameter value specified by TASK ID 6, or the successful change parameter value (16-bit) specified by TASK ID 7.
5	Transfer parameter value (32-bit)	Returns a 32-bit data value from the request parameter value specified by TASK ID 6, or the successful change parameter value (32-bit) specified by TASK ID 8.
6	Transfer last parameter reference	Returns the highest parameter for the menu specified by request last parameter reference, TASK ID 9.
7	Error - TASK ID could not be executed	The previously specified TASK ID could not be completed. Word 3 will return an error code to indicate the reason for the TASK ID failure (see table below).
8	Error - read only parameter	Target parameter specified by TASK ID 7 or TASK ID 8 is read only, and cannot be modified.

If RESPONSE ID 7 has been received, the error code can be read from word 3. This will indicate the reason why the TASK ID request failed (see Table 14.18).

**Table 14.18 PPO 4 Word error codes**

ERROR CODE	Error	Description
0	Invalid menu	The specified menu does not exist.
1	Parameter is read only	The specified parameter is read only, and cannot be written to.
2	Value out of range	The specified data value is out of range for the parameter.
3	Invalid parameter / menu	The specified parameter does not exist.
18	Parameter error	No last parameter information available.

**14.7.3 Reading parameters using PPO 4 Word mode**

Figure 14-3 shows the sequence of events required to read a drive parameter using the PPO 4 Word non-cyclic channel.

**Figure 14-3 PPO 4 Word Read sequence**

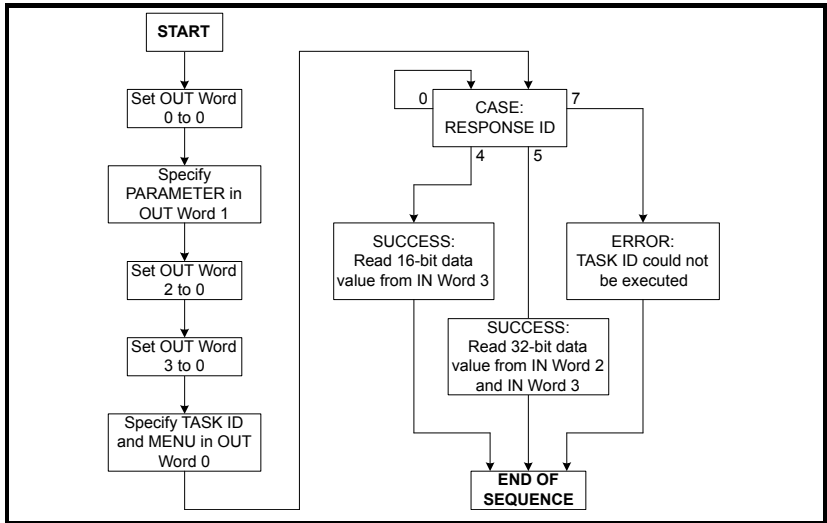


Table 14.19 shows the possible TASK ID and RESPONSE ID combinations that may be seen when attempting to read a parameter value from a drive.

**Table 14.19 PPO 4 Word Read TASK ID and RESPONSE ID combinations**

Function	TASK ID	RESPONSE ID	Message status
No Task	0	0	No message active.
Request Parameter Value (16-bit)	6	4	Parameter read successfully, 16-bit value returned in word 3.
Request Parameter Value (32-bit)	6	5	Parameter read successfully, 32-bit value returned in words 2 and 3.
Request Parameter Value (16-bit)	6	7	TASK ID 6 could not be executed. Check the error code in IN word 3 for the reason why.
Request Last (Parameter Reference)	9	6	The highest parameter reference in specified menu is available in IN word 3.
Request Last Parameter Reference	9	7	TASK ID 9 could not be executed. Check the error code in IN word 3 for the reason why.

Table 14.20 shows an example set of data words for PPO 4 Word mode. This example will read the value in the post ramp speed reference (Pr **02.001**) in the drive.

**Table 14.20 PPO 4 Word read request example**

OUT data word	Hex value	Function			
		b15-b12	b11	b10-b8	b7-b0
OUT word 0	0x6002	TASK ID = 6	0	MENU = 2	
OUT word 1	0x0100	PARAMETER = 1		0	
OUT word 2	0x0000	DATA HIGH word = 0			
OUT word 3	0x0000	DATA LOW word = 0			

Table 14.21 shows an example successful read response to the read instruction illustrated above. The value returned is 15284, which equates to 1528.4 rpm.

**Table 14.21 PPO 4 Word read response example**

IN data word	Hex value	Function			
		b15-b12	b11	b10-b8	b7-b0
IN word 0	0x5002	RESPONSE ID = 5	0	MENU = 2	
IN word 1	0x0100	PARAMETER = 1		0	
IN word 2	0x0000	DATA HIGH word = 0			
IN word 3	0x3BB4	DATA LOW word = 15284			

**NOTE**

It is important that the correct module is selected from the GSD file to ensure that the PPO 4 word mode block is consistent otherwise data skew may occur.

If the OUT data words 0 and 1 are left at the same value, the target parameter will be read or written to (depending on the TASK ID) on every data cycle.

If the PPO 4 command is left in the data words, the read will be executed on every poll of the network, effectively providing a continuous read. Care should be taken to ensure the parameters for the read are setup before the TASK ID is changed from 0 to prevent incorrect data in the returned value.

## 14.7.4 Writing parameters using PPO 4 Word mode

Figure 14-4 shows the sequence of events required to write to a drive parameter using the PPO 4 Word non-cyclic channel.

**Figure 14-4 PPO 4 Word write sequence**

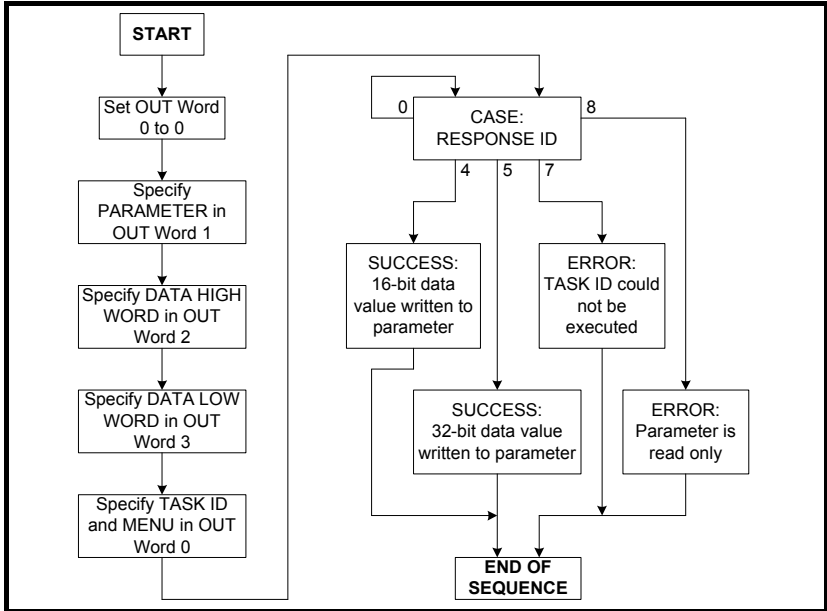


Table 14.22 shows the possible TASK ID and RESPONSE ID combinations that may be seen when attempting to write to the drive.

**Table 14.22 PPO 4 Word write TASK ID and RESPONSE ID combinations**

Function	TASK ID	RESPONSE ID	Message status
No Task	0	0	No message active.
Write Parameter Value (16-bit)	7	4	Parameter (16-bit) written successfully.
Write Parameter Value (32-bit)	8	5	Parameter (32-bit) written successfully.
Write Parameter Value (16-bit)	7	7	TASK ID 7 could not be executed. Check the error code in IN word 3 for the reason why.
Write Parameter Value (32-bit)	8	7	TASK ID 8 could not be executed. Check the error code in IN word 3 for the reason why.
Write Parameter Value (32-bit)	8	8	Parameter is read only, and cannot be written to.

Table 14.23 shows an example set of data words for PPO 4 Word mode. This example will write a value of 1553.9 rpm (32-bit value is 15539) to the digital speed reference 1 (Pr 01.021) to the drive.

**Table 14.23 PPO 4 Word write requests example**

OUT data word	Hex value	Function			
		b15-b12	b11	b10-b8	b7-b0
OUT word 0	0x8001	TASK ID = 8	0	MENU = 1	
OUT word 1	0x1500	PARAMETER = 21		0	
OUT word 2	0x0000	DATA HIGH word = 0			
OUT word 3	0x3CB3	DATA LOW word = 15539			

Table 14.24 shows an example successful write response to the write instruction illustrated above in Table 14.23.

**Table 14.24 PPO 4 Word write response example**

IN data word	Hex value	Function			
		b15-b12	b11	b10-b8	b7-b0
IN word 0	0x5001	RESPONSE ID = 5	0	MENU = 1	
IN word 1	0x1500	PARAMETER = 21		0	
IN word 2	0x0000	DATA HIGH word = 0			
IN word 3	0x3CB3	DATA LOW word = 15539			

**NOTE**

If the PPO 4 command is left in the data words, the write will be executed on every poll of the network, effectively providing a continuous write. Care should be taken to ensure the parameters for the write are setup before the TASK ID is changed from 0 to prevent incorrect data being written.

**14.7.5 Limitations of non-cyclic data Mode 1 - CT Single Word with GSD**

CT Single Word non-cyclic data uses only 1 word of data, however when used with data alignment set to 32 (see ) this requires two 16-bit words (a single 32-bit word). When used with data alignment set to 32 only the lower 16 bits of the 32-bit word are used.

**14.7.6 Using non-cyclic data Mode 2 - PPO 4 Word**

Data consistency is important when using PPO4 word (Mode 2) non-cyclic data as each non-cyclic message consists of four words. If there is data skew between any of the non-cyclic words this could result in the wrong data value being written to the wrong parameter.

The GSD file provides the PPO 4 Word which consists of four IN/OUT words with consistency.

If non-cyclic data is required and the DP-V1 non-cyclic channel is not used then the non-cyclic CT Single Word and/or the PPO 4 Word modules must be selected. A total of eight different modules can be selected to configure the input and output configuration of the node.



## 15 Glossary of terms

**Address:** This is the unique network identification given to a networked device to allow communication on a network. When a device sends or receives data the address is used to determine the source and the destination of the message.

**Bit:** A binary digit, this may have the value of 1 or 0.

**Block mapping:** A method of mapping a range of consecutive parameters using only two ascending parameters. This means that by using two mapping parameters up to 32 consecutive mappings may be made.

**Byte:** A collection of eight binary digits that collectively store a value. This may be signed or unsigned.

**Casting:** The process of changing between data sizes without changing the value represented, e.g. changing from 16-bit to 32-bit.

**Consistency:** Describes how data is transmitted between nodes on the network. If data is consistent it is transmitted from node to node as a single entity. Thus preventing data corruption where multiple bytes are transmitted or received individually.

**Control word:** A collection of binary digits that are used to control the drive. Features typically include directional controls, run controls and other similar functions.

**CT Single Word non-cyclic:** see *Mode 1 non-cyclic in this section.*

**Cyclic channel:** An area of the PROFIBUS-DP message frame used for cyclic communication to a single drive parameter.

**Cyclic data:** This consists of values that are sent at regular or cyclic intervals across the network. A typical use of cyclic data would be the transmission of a speed reference or a control word.

**Data alignment:** By default SI-PROFIBUS transmits values as 32 bits on the network. It is possible by using data alignment to reduce the number of bits transmitted when sending 16-bit (or smaller) values on the network to 16-bit (32-bit values will still be transmitted as 32 bit values). This has the advantage of reducing the volume of traffic on the network and allowing more parameters to be mapped within the SI-PROFIBUS.

**Data format:** Determines the quantity and function of the network data.

**Data rate:** Determines the communication speed of the network, the higher the value the more data can be sent across the network in the same time period.

**Device:** A piece of equipment connected to a network, this may be any type of equipment including repeaters, hubs, masters or slaves.

**Direct data mapping:** Data is sent directly to the mapping parameters in the drive rather than the parameters redirecting the data to another parameter.

Safety information
Introduction
Mechanical installation
Electrical installation
Getting started
Parameters
GSD Files
Cyclic data
Non-cyclic data
Control and status words
Diagnostics
PROFIBUS profile (V4)
Advanced features
Legacy features
<b>Glossary of terms</b>
Index

**Double word:** A 32-bit word, this may be signed or unsigned.

**DPV 0,1,2:** This describes the specification version of SI-PROFIBUS used.

**Grounding/Earthing:** Describes the electrical safety or shielding connections for the module.

**Endian format:** When a value uses more than eight bits to represent its value it needs to be sent in sets of eight bits (bytes) across the network, the endian format determines the order the bytes that constitute the whole value are transmitted.

**Event task:** A way to use a message or change of state to trigger a software routine.

**FREEZE:** A method of preventing input state changes from being sent to the master, until a FREEZE signal is sent, this is used in conjunction with UNFREEZE.

**Grounding:** See Earthing

**Groups:** Groups are used with the SYNC and FREEZE commands. A group defines which nodes respond to a specific SYNC or FREEZE command.

**GSD file:** A file that defines the properties of a node. The file contains information describing the features available on the device.

**IN data:** Data that is returned from a slave device to the PROFIBUS master.

**Long word:** A 32-bit data word that may be signed or unsigned.

**Network Loss Trip:** A way to determine when a node has lost contact with the master.

**Node:** A device on the network. This may be either a device such as a drive or part of the network such as a repeater.

**Non-Cyclic Data:** Data that is requested or sent by the master as required. This is not sent on a regular basis and generally allows access to any parameter. This is useful for occasional changes or configuration purposes.

**Main actual value:** This gives feedback on the running speed of the drive when using the PROFIdrive profile.

**Main Setpoint:** The value used to determine the speed of the drive when using the PROFIdrive profile.

**Mapping:** The process of linking PROFIBUS values to parameters within the drive.

**Master:** The controlling device on the network, generally this will include programming features.

**Mode 1 non-cyclic:** A method of sending non-cyclic data using a single word.

**Mode 2 non-cyclic:** A method of sending non-cyclic data using four words.

**PROFdrive profile:** A standardized method of controlling drives that is independent of the manufacturer.

**Poll rate:** The rate at which cyclic data is sent and received on the network.

**PPO Modes:** Different operational modes within the PROFdrive profile. PPO 4 mode is not the same as Mode 2 - PPO 4 Word mode non-cyclic data.

**PPO 4 Word non-cyclic mode:** see Mode 2 non-cyclic in this section. This is not the same as PPO4 mode.

**Response ID:** The response code of the message received when using PPO4 word non-cyclic communication.

**Scan rate:** See Poll rate in this section.

**Segment:** An electrically separate part of the network. Each segment requires correct termination to ensure reliable operation. Due to electrical limitations the maximum number of devices on a segment is limited to 32.

**Shielding:** A connection to provide additional noise immunity on a network cable.

**Slave:** A device on the PROFIBUS network such as a drive or sensor. A slave device will only respond to messages from a master.

**Status word:** A value that denotes the status of the drive. Each bit within the word will have a specific meaning.

**SYNC:** A method of preventing output state changes from being actioned by the slave, until a SYNC signal is sent, this is used in conjunction with UNSYNC.

**Task ID:** The code used to describe the purpose of a message using PPO 4 word non-cyclic communication.

**Telegram:** A message used within Mode 1 non-cyclic data communication. This term is sometimes used to represent a generic message on the network.

**Termination:** This is used at both ends of a network segment to prevent reflections and reduce noise. On PROFIBUS, termination is provided by a powered network of resistors.

**UNSYNC:** Used to restore outputs in a slave to normal operation following a SYNC command.

**UNFREEZE:** Used to restore inputs in a slave to normal operation following a FREEZE command.

**Watchdog:** A method used to determine if a communication system is ok. A typical watchdog scheme uses a handshaking system to check both the master and slave are participating in communications.

**Word:** A collection of 16 binary digits.

---

# Index

---

## Numerics

16-bit parameter access .....	89
2 cyclic channels only .....	45

## A

Abort CT single word .....	89
Above set speed .....	54
At speed .....	54

## B

Below set speed .....	54
-----------------------	----

## C

Cable .....	13
Cable shield connections .....	13
Cautions .....	5
Compliance .....	6
Configuring the profile .....	77
Connectors .....	13
Consistency .....	42
Control word .....	51
CT single word protocol .....	80
Current limit .....	54
Cyclic data .....	44, 75

## D

Data alignment .....	44, 75
Data configuration .....	42
Data formats .....	44
Data mapping errors .....	46
Device loading .....	14
Diagnostics .....	56
Disabling cyclic data channels .....	47
Disabling mappings .....	47
DP-V1 Drive Identification .....	74
DP-V1 Fault Buffer .....	72, 73
DP-V1 Identification and Maintenance Functions .....	74
DP-V1 Parameter Access .....	49
DP-V1 PROFIdrive PNU access .....	71
DP-V1 Standard Telegram 1 .....	61
DP-V1 State Machine .....	63
Drive active .....	54
Drive Identification .....	74
D-Type pin out .....	12
Dynamic brake active .....	54

## E

Electrical installation .....	12
Electrical safety .....	5
Environmental limits .....	6

<b>F</b>	
Fault Buffer .....	72
Formats .....	44
FREEZE .....	75
<b>G</b>	
Getting started .....	15
Glossary of terms .....	97
GSD .....	42
GSD compatibility .....	43
<b>H</b>	
Hardware enable .....	51
<b>I</b>	
Inter-option communication timing .....	75
<b>J</b>	
Jogging .....	67
<b>M</b>	
Mapping errors .....	46
Mapping parameters .....	45
Mode 1 .....	79, 96
Mode 2 .....	90, 96
<b>N</b>	
Network compatibility mode .....	76
Network length .....	14
Network loss timeout error .....	75
Network termination .....	13
Node address .....	17
Non-cyclic data .....	48
Non-cyclic mode .....	79
Normal Run Sequence .....	63
<b>O</b>	
Option module identification .....	10
Overview .....	9
<b>P</b>	
Parameters - adjusting .....	6
PPO 1 .....	77
PPO 2 .....	77
PPO 3 .....	61, 78
PPO 4 .....	78
PPO 4 word .....	96
PPO 4 word mode .....	90
PPO 4 word read .....	93
PPO 4 word write .....	95
PPO 5 .....	78
PPO types .....	61
PROFIBUS DP-V1 Overview .....	48
PROFIdrive (V4) State Machine .....	63
PROFIdrive control word .....	68

PROFIdrive PNU access .....	71
PROFIdrive profile .....	61
PROFIdrive status word .....	69
PROFIdrive V4 General State Machine Diagram .....	65
PROFIdrive V4 Speed Control State Machine Diagram .....	66
<b>R</b>	
Reading parameters using CT Single Word .....	81
Regenerating .....	54
Running at or below minimum speed .....	54
<b>S</b>	
Safety of personnel .....	5
Set-up flow chart .....	16
Single word .....	96
Single word mode .....	79
Single word non-cyclic data .....	80
Specification .....	9
Speed Control State Machine .....	66
Spurs .....	14
Standard Telegram 1 .....	61
Status word .....	53
Status word bit functions .....	54
Stopping the motor using PROFIdrive .....	67
SYNC .....	75
SYNC and FREEZE Mode .....	75
<b>T</b>	
Telegrams .....	82
Terminal descriptions .....	12
Termination .....	13
<b>U</b>	
UNFREEZE .....	75
Unidrive SP control word .....	51
UNSYNC .....	75
<b>V</b>	
V4.0 General State Machine Diagram .....	65
<b>W</b>	
Warnings .....	5
Watchdog .....	99
Writing parameters using CT Single Word .....	86
Writing parameters using PPO 4 Word mode .....	95
<b>Z</b>	
Zero speed .....	54





**0478-0011-02**